



21
22

 [®]
elegance in LED lighting

All prices are recommended gross sales prices excluding VAT. Our general terms and conditions apply. Errors and availability reserved. All articles are basically delivered without illuminants, unless the product description specifies otherwise.

5 YEAR MANUFACTURER'S WARRANTY

All DEKO-LIGHT brand products come with a five-year extended warranty.

DEKO-LIGHT lighting solutions have always stood for maximum reliability and performance based on strict quality guidelines. For example, the products are regularly checked during the development and production process in order to provide users from all sectors with a fault-free product. The extension of the manufacturer's warranty underlines this quality promise once again.



- 04 information
- 10 highlight products

INTERIOR LIGHTS

- 42 pendant lights
- 88 surface mounted ceiling lights
- 114 built in ceiling lights
- 160 surface mounted wall lights
- 196 built in wall lights
- 202 reading lights
- 208 table and floor lights
- 222 furniture lights
- 238 showcase lights

BATTERY AND SOLAR LIGHTS

- 248 battery lights
- 262 solar lights

OUTDOOR LIGHTS

- 270 bollard lights
- 298 surface mounted wall lights
- 358 ceiling and wall lights
- 368 built in wall lights
- 378 spherical and floor lamps
- 386 energy distributor
- 390 surface-mounted and ground spike floodlights
- 410 wall washer
- 416 ground recessed lights
- 450 underwater lights

COMMERCIAL LIGHTS

- 466 built in ceiling lights
- 494 insert panels
- 516 ceiling and wall lights
- 538 pendant lights
- 554 floor lights
- 564 hall floodlight
- 574 damp-proof luminaires
- 584 floodlights
- 596 display lights
- 600 effect lights
- 608 emergency lights

POWER RAILS

- 616 D LINE power rail system
- 644 power rail spotlight

ALUMINIUM PROFILES

- 672 5 steps to linear light
- 674 lighting solution
- 684 assembly | configurator
- 686 homogeneous light image
- 680 aluminium profiles | overview
- 688 aluminium profiles | quick finder
- 694 covers | overview
- 697 RAL coating
- 700 U-profiles | flat + high | built-in/built-on
- 712 T-profiles | flat + high | built-in
- 724 H-/groove-profiles
- 734 step/plinth/angle/corner profiles | built-in/built-on
- 762 dry construction profiles
- 776 tile profiles
- 792 profiles for outdoor use | walkable/trafficable
- 802 assembly notes | assembly instructions
- 805 complete sets | IP67 | trafficable

LED STRIPES

- 808 technical information
- 818 information soft grouting and hard grouting
- 820 quick finder
- 824 COB | 1CH | 24V
- 828 COB | 2CH | 24V
- 830 COB | 3CH | 24V
- 832 standard | 1CH | 12V
- 836 standard | 1CH | 24V
- 842 standard | 1CH | 48V
- 846 standard | 2CH | 12V
- 848 standard | 2CH | 24V
- 852 standard | 3CH | 24V
- 856 standard | 4CH | 24V
- 860 standard | 3+2CH | 24V
- 862 D LENSE LINE | 1CH | 24V
- 864 D LENSE LINE | 3CH | 24V
- 866 D FLEX LINE Top-View | 1CH | 24V
- 870 D FLEX LINE Top-View | 3CH | 24V
- 872 D FLEX LINE Top-View | 4CH | 24V
- 874 D FLEX LINE Side-View | 1CH | 24V
- 878 D FLEX LINE Side-View | 3CH | 24V
- 880 D FLEX LINE Side-View | 4CH | 24V
- 882 230V | 1CH
- 884 assembly notes | assembly instructions
230V LED stripe

POWER SUPPLIES

- 892 technical information
- 895 DC | CV | quick finder
- 899 DC | CV | not dimmable
- 901 DC | CV | not dimmable | IP
- 904 DC | CV | dimmable via phase control or phase cut-off
- 906 DC | CV | dimmable via 1-10V
- 908 DC | CV | dimmable via DALI / DALI+1-10V / touch dim
- 910 DC | CV | dimmable via KNX
- 911 DC | CV | dimmable via DMX
- 912 DC | CC | quick finder
- 914 DC | CC | not dimmable
- 918 DC | CC | dimmable via phase control or phase cut-off
- 922 DC | CC | dimmable via DALI / DALI + Intelli-touch dim
- 925 DC | CC | dimmable via KNX
- 926 DC | CC/CV | dimmable via phase control or touch dim
- 927 AC | CV | quick finder
- 928 AC | CV | dimmable via phase control or phase cut-off
- 929 AC | CV | dimmable via phase control
- 930 gear units for metal vapour lamps

CONTROLLER

- 934 Quasar
- 944 Casambi Bluetooth
- 946 RF controller | 1 - 4 channel
- 948 RF touch panel | 1 - 4 channel
- 950 quick finder | DMX controller
- 951 quick finder | DMX dimmer
- 952 DMX wall controller
- 956 DMX controller
- 958 DMX dimmer
- 962 DALI PWM dimmer

ACCESSORIES

- 986 indoor | dimming
- 988 indoor | dimming + switching
- 989 indoor | other
- 990 indoor | low voltage
- 992 indoor | low voltage | plug-in connector
- 994 outdoor | low voltage | WEIPU HQ plug-in connector
- 998 indoor / outdoor | DMX cable
- 1000 indoor | high voltage
- 1001 indoor | high voltage | plug systems
- 1002 outdoor | high voltage | plug systems
- 1004 outdoor | cable connectors
- 1008 outdoor | mounting accessories
- 1009 indoor / outdoor | mounting material for LED stripes and profiles
- 1010 indoor / outdoor | mounting accessories
- 1012 sales aid | sample case

1014 legend

1016 index

ILLUMINANTS

- 966 G4
- 967 MR16/GU5,3
- 969 GU10
- 971 GU10/ES111
- 972 E14
- 973 E27
- 978 G9 | G53/QR111 | GX53
- 979 R7S
- 980 neon tubes
- 981 metal vapour lamps



LIGHT COLOUR SELECTABLE

Luminaires with the designation "CCT Dip" allow you to change the light colour via a small dip switch [usually in the steps 3000K / 4000K / 5000K]. With their high application flexibility, CCT Dip luminaires offer customers who are still unsure about the light colour an enormous decision-making aid - and incidentally reduce your stock requirements.

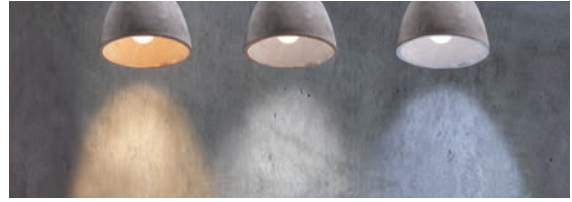

The colour temperature [light colour] is specified in Kelvin [K] and determines how the respective light is perceived.

WW = Warm white light	2,300 K to 3,300 K [high red component].
NW = Neutral white light	3,300 K to 5,300 K
CW = Cool white / daylight white light	5,300 K to 8,000 K [high blue content]

The following guide values apply as orientation for different rooms following guide values apply:

living and sleeping are	WW
kitchen and bathroom	WW NW
offices	NW
industry	NW CW
photo studio / architectural lighting	CW



COLOUR RENDERING INDEX RA

The colour rendering index Ra is the measure of the correspondence of the perceived light colour between an existing lighting situation and a reference light source. The smaller the deviation, the better the colour rendition. A light source with Ra 100 reproduces all colours exactly. The lower the Ra value, the less precisely the colours are reproduced.

Standard values:	
Incandescent bulb, halogen lamps	up to Ra 100
LED lamps	Ra 75-95
Compact fluorescent and energy-saving lamps	Ra 80-89
Fluorescent lamps	Ra 70-85



RA 70-80 medium colour rendition



RA 80-90 good colour rendition



RA 90-100 very good colour rendition



HCL

HCL stands for "Human Centric Lighting" and means the simulation of lighting situations according to the biological day-night rhythm of humans. HCL matches artificial light indoors to natural daylight and promotes well-being, mood and health. Numerous DEKO-LIGHT luminaires can already be integrated into an HCL control system to adjust the light colours to the biorhythm. In addition, several LED stripes in different light colours can be combined in one profile and thus integrated into the HCL lighting design.

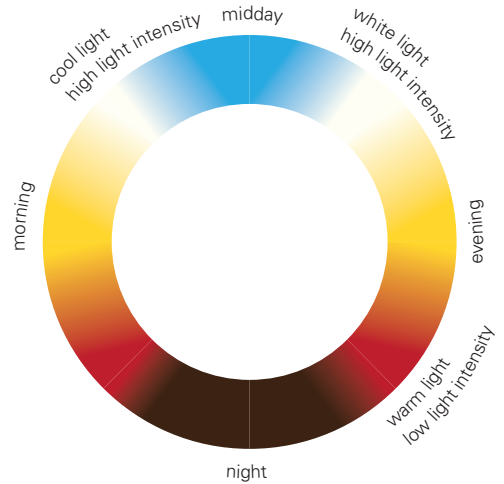

UGR VALUE

The smaller the UGR value, the more glare-free a luminaire emits its light. Especially in office areas, luminaires with a UGR value of less than 19 should be used to avoid disturbing reflections. When determining the UGR value of a complete room, additional factors such as wall colour[s] and surface finishes play a role.



DIM TO WARM

With the dim-to-warm function, you not only adjust the luminous intensity downwards, but by simultaneously changing the light colour [e.g. from 3000 to 2000 K], you obtain a room mood adapted to the new situation. LED luminaires with dim-to-warm technology can therefore be used particularly flexibly.



DALI-DIMMABLE

Luminaires that can be dimmed via DALI can be perfectly integrated into lighting/property management systems. The great advantage lies in the wiring: via DALI, all luminaires in a line can be individually addressed and controlled.

But this variant is also suitable for individual luminaires: DALI dimmers without an address exist for this purpose, which address the power supply unit directly. The good news: most systems on the market already have DALI interfaces.



HIGH LUMEN PACKAGE

Luminaires with high lumen values are ideal for illuminating rooms or corridors. With the right wall luminaires, you can achieve the prescribed lux values for corridors [100 lux] in many cases without additional ceiling lighting.

WHAT IS HOW BRIGHT?

How many lumens do different lamps shine with?

candle	~ 12 lm
100W incandescent bulb	~ 1.340 lm
40W fluorescent lamp	~ 3.000 lm

WHERE DO I NEED HOW MANY LUMENS?

You should plan for these lumens per square metre, so that your home is optimally and comfortably illuminated:

guide values:	
living room	approx 140 lm/m ²
bedroom	approx 140 lm/m ²
children's room	approx 140 lm/m ²
hallway	approx 140 lm/m ²
study	approx 280 lm/m ²
kitchen	approx 280 lm/m ²
bathroom	approx 280 lm/m ²

HOW MANY LUMENS CORRESPOND

HOW MANY WATT?

Luminous efficacy is measured in lumens per watt [lm/W] and indicates how efficiently a lamp shines and how energy is converted into light.

guide values:	
incandescent bulb	approx 10 lm/W
halogen lamp	approx 20 lm/W
fluorescent lamp	approx 70-90 lm/W
LED lamp	approx 60-170 lm/W

WHAT DOES "LUX" MEAN?

Lux [lx] is the physical unit of the illuminance of a light source. This photometric quantity indicates how much luminous flux from a light source falls on a given surface.

Of course, the following values do not have to be achieved in the entire room.

guide values:	
bedroom	45 Lux
living room	77 Lux
bathroom	110 Lux
hallway	207 Lux
study/office	300 Lux [at desk: 500 Lux]



IK-VALUE

In addition to the IP protection class, you should also keep an eye on the IK value of a luminaire, which is increasingly required within the scope of tenders and for installations in public spaces. The IK value [or IK impact resistance level] indicates how impact-resistant a luminaire or certain components are. IK00 offers no protection against external mechanical stress, IK10 or IK10+ means that the luminaire can withstand a 5 or 10 kg test weight from a distance of 40 or 50 cm.

There are eleven codes, corresponding to the impact energy that an enclosure can withstand. [Source: wikipedia.org]

code	impact energy in joules	corresponds to drop height in mass	
IK00	no protection		
IK01	0,14	7 cm	- 200 g
IK02	0,20	8 cm	- 250 g
IK03	0,35	14 cm	- 250 g
IK04	0,50	20 cm	- 250 g
IK05	0,70	28 cm	- 250 g
IK06	1,0	40 cm	- 250 g
IK07	2,0	40 cm	- 500 g
IK08	5,0	25 cm	- 2000 g
IK09	10,0	20 cm	- 5000 g
IK10	20,0	40 cm	- 5000 g
IK10+	50,0	50 cm	- 10000 g



CHANGEABLE LED CHIPS

We want to leave our children a world worth living in. With the advent of LED technology, many luminaires could no longer be repaired and became disposable products. Thanks to a high recycling rate, a large part of the raw materials can already be returned to the system - nevertheless, we want to do even better: Ideally, the LED or the POWER SUPPLY of every DEKO-LIGHT luminaire can be replaced in the event of a malfunction. With the new Green Label "LED chip replaceable", the DEKO-LIGHT brand is sending an unmistakable signal: Luminaires with this label enable environmentally friendly replacement of LED chips. In combination with low power consumption and a long service life, DEKO-LIGHT luminaires are already helping to reduce the burden on the environment. Support us in this and look out for the Green Label at DEKO-LIGHT.



WHAT IS THE "AVERAGE RATED LIFE" OF AN LED?

The average rated service life of LEDs covers the period from the first time they are switched on until the time when only 50 percent of the LEDs tested are still functioning properly.

A specified service life of 30,000 hours for an LED stripe therefore means that after this period, on average, half of all stripes will have failed.

WHAT DOES "BINNING" MEAN?

Binning guarantees a constant quality of light with the same brightness level and uniform light colour. For this purpose the LEDs of a production batch are sorted and divided into so-called "bins".

NORM TABLE

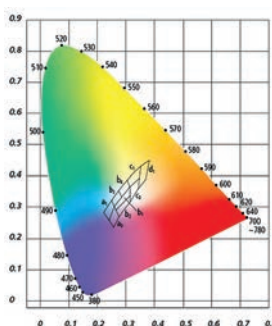

BINNINGS

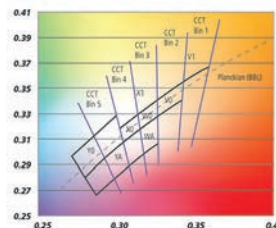

WHITE LEDS

With the kind support of Licht von Klein / www.licht-von-klein.de



IP PROTECTION ZONES

ZONE 3 | IP23

Outside zones 0 to 2, no special IP protection is necessary, provided no cleaning with direct water irradiation takes place.

ZONE 2 | IP44

In the areas 60 cm from zone 1, IP X4 protection applies.

ZONE 1 | IP65

In the wall area of the shower as well as in the tile area exposed to IP X5 is specified for the wall area of the shower and in the tile area exposed to splash water [max. 50 V].

ZONE 0 | IP67

In bathtubs and shower trays, low-voltage [max. 12 V] is absolutely required. The minimum IP protection is IP X7 [protected against water penetration].

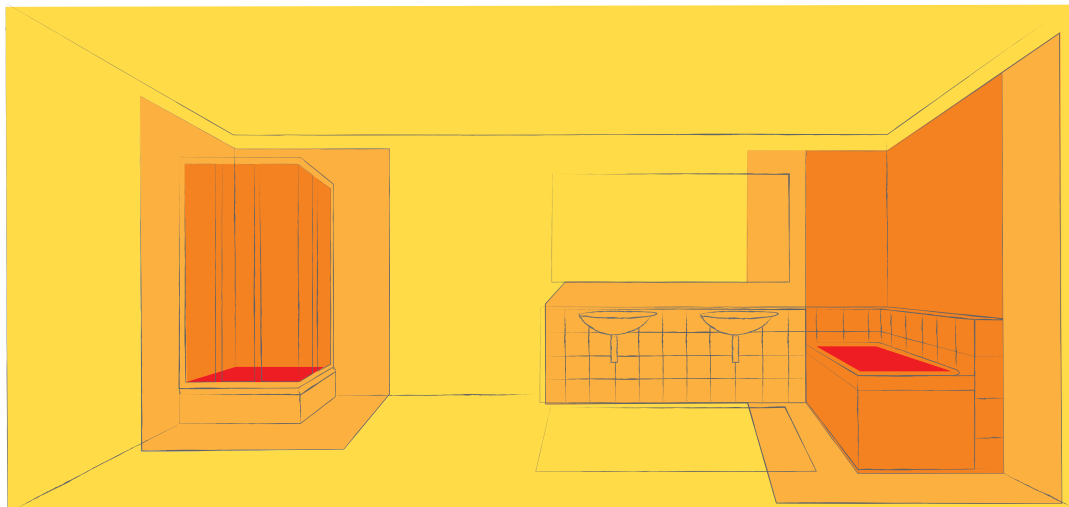
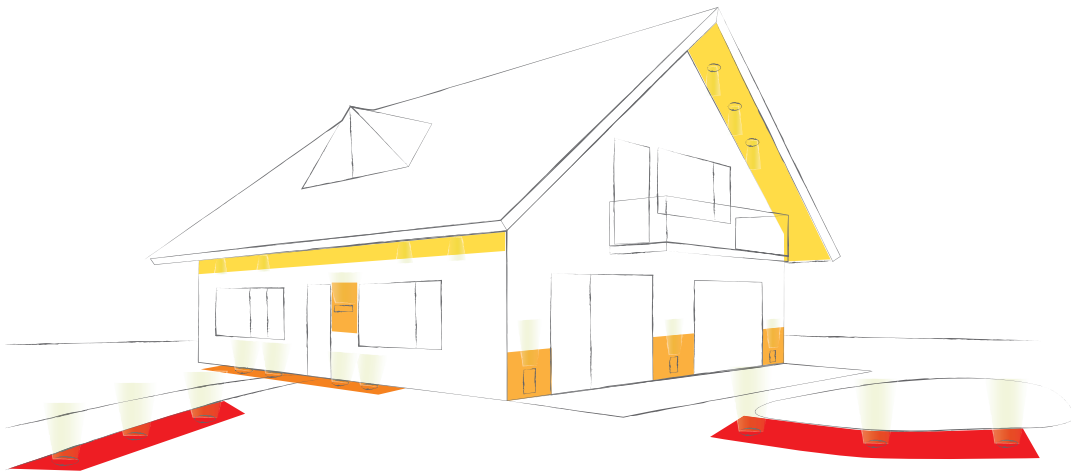

PROTECTION TYPES AND INSULATION CLASSES

Luminaires and other electrical appliances have a housing that protects live parts from contact, moisture or other environmental influences. This protection depends on the respective area of application. In order to have an overview of the suitable application, all devices are assigned to a classified protection type and an insulation class.

IP67

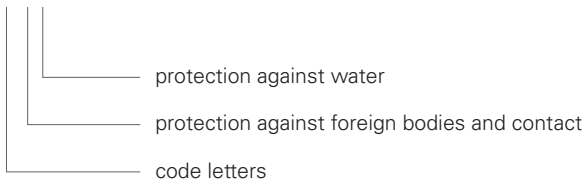

1. digit	protection against foreign bodies and contact	2. digit	protection against water
0	no protection	0	no protection
1	large foreign bodies [Ø > 50 mm] large body parts [e.g. back of the hand]	1	protection against vertically falling dripping water
2	medium-sized foreign bodies [Ø > 12 mm] finger	2	protection against dripping water falling at an angle [up to 15°].
3	small foreign bodies [Ø > 2,5 mm] tools and wires [Ø > 2,5 mm]	3	protection against water spray up to 60° from vertical
4	granular foreign bodies [Ø > 1 mm] tools and wires [Ø > 1 mm]	4	protection against splashing water on all sides
5	dust deposit complete protection against accidental contact	5	protection against jet water
6	dust entry complete protection against accidental contact	6	protection against strong jets of water
		7	protection against temporary immersion
		8	protection against permanent immersion



HIGH QUALITY MATERIAL MIX

The MADERA series is made of first-class European oak wood and impresses with its modern design and mix of materials in private living areas, hotels, restaurants and many more. The noble MADERA luminaires distribute their powerful warm white light in any room and thus also cut an excellent figure as functional and high-quality lighting at reception counters and more.

You can find more information on the following pages:
ceiling light 348147 | page 112
pendant lamp 342169 | page 86
wall light 341248 | page 134
table lamp 346044 | page 220



QUICK FACTS

- modern, exclusive design
- manufactured in Europe from high-quality oak wood of quality class A
- FSC-certified raw material oak wood
- high light intensity



THE HEAD

The head is the starting point and centre of the MIRAM-series and, thanks to its magnetic fastening, can be combined with all holders. Once charged via a USB-C cable, the head lights up for more than 10 hours and can be dimmed continuously via a touch switch. dimmer via a touch switch.



THE WALL HOLDER

With the easy-to-mount wall bracket via two screws, you can use the MIRAM head on exterior and interior walls. Thanks to the compact dimensions of the entire series, you can easily use several brackets and heads in a small space.



THE STAND

With the stand, the MIRAM becomes a mobile table lamp - whether for a spontaneous round of skat on the terrace, as an individually dimmable lamp in cafés or as a colourful desk lamp that provides children with light for their homework even in the cold, dark season.



THE PENDANT

The trapezoidal pendant makes placing the MIRAM particularly easy: no drilling, no screwing - simply wrap it around a pole, beam or sturdy tree branch and the MIRAM will light up even a picnic in the great outdoors.

COLOURFUL FLEXIBILITY

The MIRAM is THE luminaire for almost all wireless outdoor applications. The combination of a central, magnetic luminaire head and interchangeable holders - each in seven colours - set no limits to creativity. Whether as a wall, table or pendant luminaire - with the battery-operated MIRAM series, you can bring light anywhere: in the garden, outdoor restaurants, as ambient lighting or in the children's room. Charging is quick and easy via USB-C. In addition, the MIRAM is infinitely dimmable via the integrated touch switch.

More information can be found from page 250.

QUICK FACTS

- type: rechargeable magnetic luminaire
- connection: USB-C
- diameter: 12 cm (head)
- material: die-cast aluminium
- light colour: 3,000 K, warm white
- IP54
- colours: yellow, blue, green, red, black, white, grey

MIRAM

LIGHT - ALL AROUND

The ALHENA is a thoroughly modern floor luminaire for outdoor use: a slim housing paired with an impressive 360° light distribution and high energy efficiency. What's more, thanks to its SMD construction, the towering ALHENA not only serves to illuminate gardens, car parks, walkways and more, but also impresses with its timeless design as a visual eye-catcher when switched off.

More information can be found on page 297.



With the kind support of Arte Classica Schinzel / www.arte-classica.de



QUICK FACTS

- timeless design
- all-round lighting [360° light distribution]
- UV-resistant
- high energy efficiency

ALHENA



VARIABLE INSTALLATION DIMENSIONS

Recessed ceiling luminaires can be discreetly integrated into both private and commercial spaces, but when a replacement is due, the existing ceiling cut-out can become a problem. The ZAURAK series comes with an adjustable mounting bracket that allows larger or smaller ceiling cut-outs to be used. In addition, the ZAURAK has a low installation depth for universal use. The scope of delivery includes two interchangeable cover rings in silver and black.

More information can be found from page 484 onwards.

article	ceiling cut-out	colour	temperature	luminous flux
565327	65 - 160 mm	3000/4000/5700 K		1060 lm
565328	120 - 200 mm	3000/4000/5700 K		1750 lm
565329	150 - 270 mm	3000/4000/5700 K		2420 lm



QUICK FACTS

- light colour adjustable via switch [CCT Dip]
- adjustable mounting bracket for different cut-out dimensions
- 230V direct connection
- through-wiring possible
- silver and black cover ring included in delivery
- low installation depth - universal use





ZAURAK



ALL-ROUNDER AT A FAIR PRICE

Anyone looking for a slim, powerful, energy-efficient and flexibly usable 3-phase spotlight will not get past HORUS. The slim housing and matt finish of the surface, combined with the powerful chip through all wattages, make the HORUS spotlights a true all-rounder in salesrooms, hotels, the catering trade and other commercial application areas.

More information can be found from page 654.





HORUS



QUICK FACTS

- super price-performance ratio
- >100 lumens per watt
- high energy efficiency



Foto: Daniel Neiser . Architekturfotografie, Karlsruhe

DOWN TO THE LAST CORNER

The perfect effect of linear light depends not only on the LED stripe used, but especially on its clever placement. For use in ceiling and wall coving, suspended ceilings and other indirect lighting scenarios, DEKO-LIGHT has a 135° angle profile in a modern, timeless design in its portfolio. Manufactured made of high-quality aluminium with high dimensional accuracy and dimensional stability, the angle profile can be easily shortened to the individually required length and precisely integrated into both private and commercial rooms.

You can find more information on page 742.

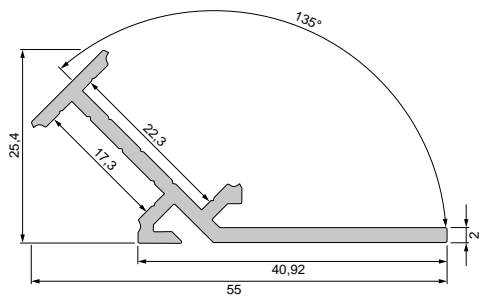



QUICK FACTS

- high quality aluminium
- high dimensional accuracy
- high dimensional stability
- can be easily shortened to desired length
- modern timeless design

135° angle profile



INTENSIVE PLAY OF COLOURS

LED stripes with COB technology enable particularly homogeneous light. The COB RGB stripe from DEKO-LIGHT places 840 RGB LEDs on a one-metre length and offers lighting designers and electricians the ideal combination of rich, intense colours, flexible illumination and easy installation, as the stripes can be quickly and easily shortened to the individual desired length - for use in the kitchen, living room or bedroom and much more.

For more information, see page 830.

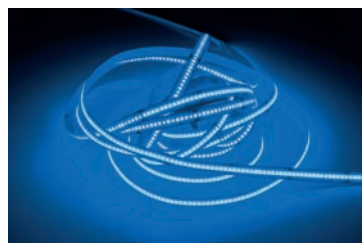



LED stripe COB RGB

QUICK FACTS

- homogeneous light thanks to COB technology
- high flexibility
- can be easily shortened to desired length
- COB 840 LED/m
- intensive colour rendering



Foto: Daniel Vieser - Architekturfotografie, Karlsruhe

MULTITALENT

A must for every electrician: the new MULT-CC DALI 2.0 power supply units from DEKO-LIGHT are a real all-purpose weapon for universal use.

They can be controlled via DALI1 or DALI2 [fully upward and downward compatible] or via Intelli-Push. The multi-current power supply units do not require any additional control components and are controlled by means of cost-effective 230V standard push-buttons. With the new Intelli-Push function, they also have a pioneering synchronisation option if one of the connected POWER SUPPLIES no longer runs synchronously with the others.

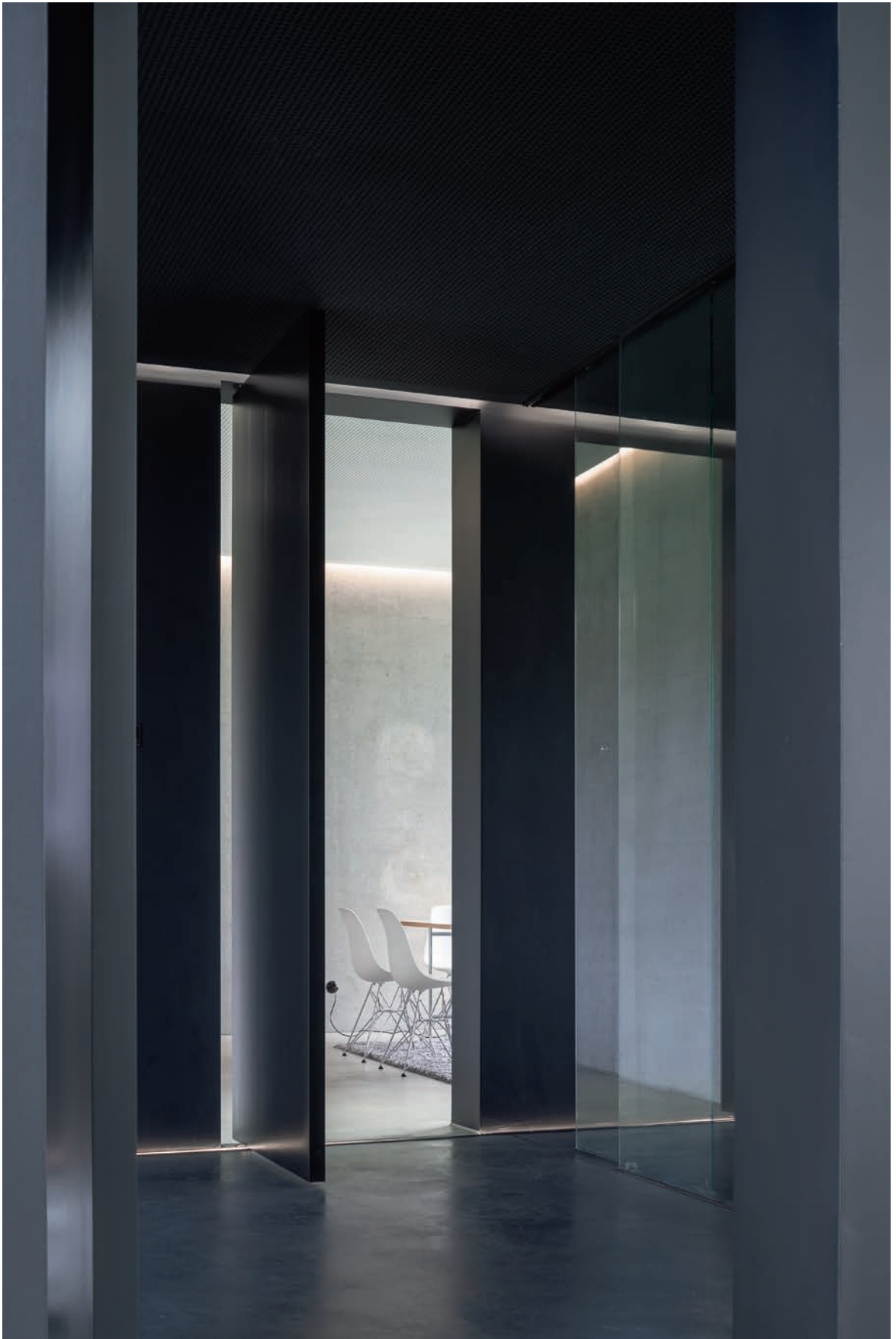
In addition, the MULTI power packs can also be operated without control, undimmed, as a reliable and universal power supplier. With a total of five models, the new DALI series covers a CC current range from 180mA to 1600mA and power ratings from 4 to 75 watts.

More information can be found on page 922.



QUICK FACTS

- these POWER SUPPLIES are a super all-purpose weapon - universally applicable
- with Dali1/2 control, fully upward and downward compatible
- new Intelli-Push function [controllable with one or more simple 230 push-buttons]
- no additional control components necessary

Multi-Current DALI 2.0

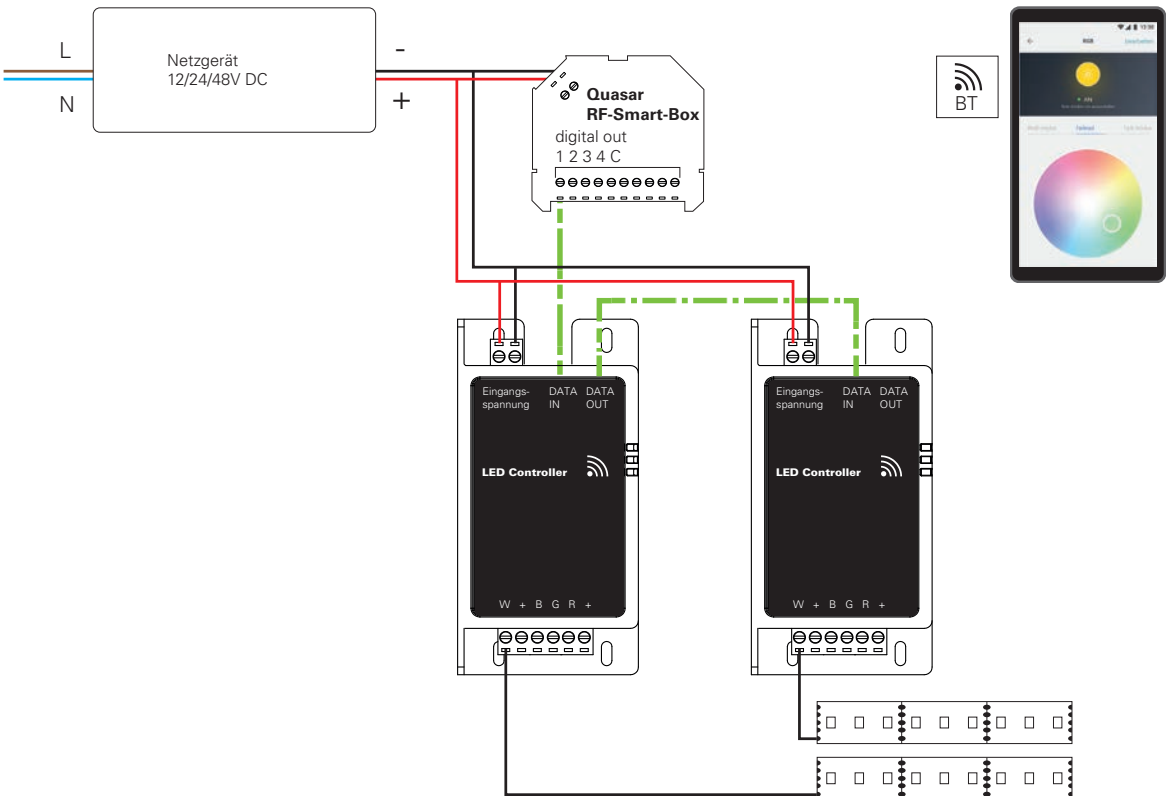

NOW EVEN SMARTER

The small blue RF Smart Box is a real all-rounder, because on the one hand it makes it possible to operate an existing LED stripe installation, which was previously controlled with the popular DEKO-LIGHT RF system via remote control, can now be operated with a smartphone and thus benefit from the possibilities and advantages of a modern control system.

The conversion is very simple: connect the RF Smart Box to the existing LV power supply, plug it into the RF controller and you're done! Afterwards, the app, which is available free of charge, can be put into operation and adapted accordingly.

Furthermore, in future there will be no performance limits to your planning with Quasar. Using the RF-Link control signal, you can control one or more RF controllers connected with RJ45 cables simultaneously. In this way, you can also realise high performance requirements of more complex or extensive installations.

For more information, see page 942.



QUICK FACTS

- stand-alone or networked operation
- digital output signal [RF-Link] for control of DEKO-LIGHT RF controllers [Single, WW/CW, RGB, RGBW see p. 946]
- adjustable and freely configurable: colours, brightness, programmes, speed
- data transmission via state-of-the-art BT mesh technology

Quasar



COLOURFUL DIVERSITY

The LED E27 RF RGBW is a versatile light source for E27 sockets that can be controlled and dimmed via the supplied RF remote control at a range of up to 20 metres. Adjust the light colour in the RGBW colour range, access 12 effect programmes or save your own presets thanks to the integrated memory function and address several lamps at once if required. The application possibilities are almost unlimited.



QUICK FACTS

- dimmable and controllable via RF remote control - 20 metre range
- light colour adjustable
- 12 effect programmes and memory function
- several lamps can be addressed

LED E27 RF RGBW

THE SECURE CONNECTION

Our multi-outdoor cable junction boxes ensure clean cable management in gardens, parks and other outdoor areas and protect your cables against various outside influences. The junction boxes are supplied with various adapter sleeves to connect cables with different cross-sections in a watertight manner (M20 or M25 cable glands). The waterproof cover, which is also screwed on, allows subsequent access to the laid cables. Unused connections can be secured with the supplied blanking plugs.





QUICK FACTS

- access to cables via screwed, waterproof cover
- supplied blanking plugs for unused cable entries
- waterproof cable gland
- incl. adapter sleeves for different cable cross-sections



distribution boxes



INTERIOR LIGHTS

- 42 pendant lamps
- 88 surface mounted ceiling lights
- 114 built in ceiling lights
- 160 surface mounted wall lights
- 196 built in wall lights
- 202 reading lights
- 208 table and floor lights
- 222 furniture lamps
- 238 showcase lights





ASTEROPE SERIES

pendant lamps rund 342129, 342132, 342130, 342133,
342131, 342134 | from page 46
pendant lamps linear 342135, 342136 | page 47
table lights 346003, 346004 | page 216
floor lights 343020, 343021 | page 216





TWISTER SERIES

pendant lamps 342144, 342145 | page 70

table light 346010 | page 218

floor light 343017 | page 218





BRAHE SERIES

wall lights 341242, 341243 | page 204
reading lights 341236, 341237 | page 204
table lights 346015, 346016 | page 210
floor lights 343025, 343026 | page 210



MADERA SERIES

ceiling light 348147 | page 112
pendant light 342169 | page 86
Wandleuchte 341248 | page 134
table light 346044 | page 220
floor light 343031 | page 220



BERMUDA SERIES

wall lights 342159, 342160 | page 162

table lights 346018, 346017 | page 212

floor lights 343029, 343028 | page 213



□ □ □
□ □ □
page 45



□ □
page 47



□ □
page 47



□ □ □
page 48



□ □
page 51



□ □
page 51



□ □ □
page 52



□ □ □
page 52



□ □ □
page 55



□ □ □
page 55



□ □
page 56



□
page 58



□
page 60



□ □
page 62



□ □
page 62



□ □
page 63



□ □
page 63



□ □
page 64



□ □
page 64



□
page 66



□
page 66



□
page 67



□
page 67



□ □
page 68

pendant lamps



□
page 70



□
page 72



□
page 72



▧
page 74



▧
page 74



▧ □ □
page 76



□
page 78



□
page 78



▧
page 80



□
page 82



▧
page 84

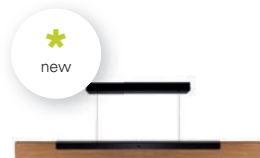

■
page 86

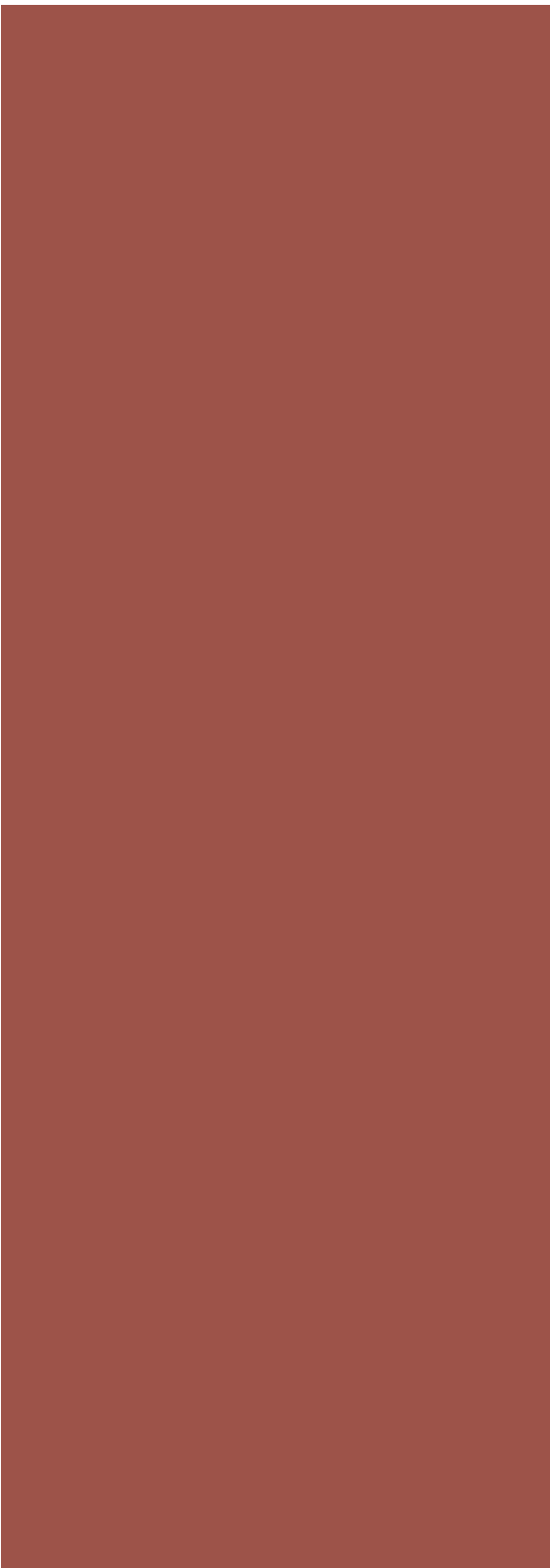



DIVERSITY

As colourful as life itself - with DIVERSITY we set an example for more colour and diversity. The pendant luminaire series based on a patented design by Johannes Tomm offers a choice of seven colours and can be combined as desired. With a cable length of 3 metres, DIVERSITY is also convincing in high rooms. The retrofit compatibility with all E27 light sources of the A60 design allows even more variety.



DIVERSITY

- Design by Johannes Tomm
- wide range of colours
- Retrofit [replaceable E27 bulb]
- suitable for all E27 bulbs of type A60
- 3m cable length
- metal
- dimensions L x Ø: 200 x 280 mm
- socket H x Ø: 25 x 100 mm
- max. suspension: 3000 mm
- dimmable via optional illuminants

342170		Pure white RAL 9010	59,95 €
342172		Basalt grey RAL 7012	59,95 €
342171		Jet black RAL 9005	59,95 €
342173		Ruby red RAL 3003	59,95 €
342174		Saffron yellow RAL 1017	59,95 €
342175		Cobalt blue RAL 5013	59,95 €
342176		Leaf green RAL 6002	59,95 €



suitable illuminants on page 974-977



ASTEROPE

Light & shadow: Hardly any luminaire embodies this dualism more beautifully than the ASTEROPE in its various versions. The downward-opening pendant luminaire creates a multifaceted play of light and shadow on walls and ceilings that blends extravagantly yet harmoniously into any ambience. Our tip: Combine the ASTEROPE with a gold-coloured or milky light source from the Filament series.

ASTEROPE RUND 250

- metal
- dimensions L x Ø: 1400 x 250 mm
- socket H x Ø: 25 x 120 mm
- max. suspension: 1155 mm
- dimmable via optional illuminants

342129 white mat

79,95 €

342132 black mat

79,95 €



suitable illuminants on page 974-977



ASTEROPE LINEAR

- metal
- dimensions L x H x Ø: 1500 x 300 x 150 mm
- socket H x Ø: 25 x 120 mm
- max. suspension: 1175 mm
- dimmable via optional illuminants

342135 white mat

79,95 €

342136 black mat

79,95 €



suitable illuminants on page 974-977



suitable
wall lights
page 164
341216
341217



suitable
table /
floor lights
page 216
346003
346004
343020
343021



ASTEROPE RUND 400

- metal
- dimensions L x Ø: 1500 x 400 mm
- socket H x Ø: 25 x 120 mm
- max. suspension: 1095 mm
- dimmable via optional illuminants

342130 white mat **159,95 €**
342133 black mat **159,95 €**

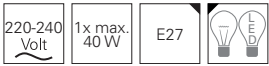

suitable illuminants on page 974-977



ASTEROPE RUND 500

- metal
- dimensions L x Ø: 1600 x 500 mm
- socket H x Ø: 25 x 120 mm
- max. suspension: 1105 mm
- dimmable via optional illuminants

342131 white mat **219,95 €**
342134 black mat **219,95 €**



suitable illuminants on page 974-977





APOLLON



The slim and purist pendant lamp APOLLON fits seamlessly into almost any ambience and provides a rich warm white light in addition to the noble look. The APOLLON is available in two different sizes with a matte surface in black and white.





APOLLON

- slim, elegant design
- high colour rendering [Ra >90]
- made of high-quality material
- aluminium
- dimensions L x W x H: 1004 x 80 x 8 mm
- socket L x W x H: 650 x 35 x 48 mm
- max. suspension: 3000 mm
- dimmable via leading or trailing edge

342149	<input type="checkbox"/>	white mat		2700 K	1755 lm	299,95 €
342148	<input checked="" type="checkbox"/>	black mat		2700 K	1755 lm	299,95 €



APOLLON

- slim, elegant design
- high colour rendering [Ra >90]
- made of high-quality material
- aluminium
- dimensions L x W x H: 1464 x 80 x 8 mm
- socket L x W x H: 850 x 35 x 48 mm
- max. suspension: 3000 mm
- dimmable via leading or trailing edge

342151	<input type="checkbox"/>	white mat		2700 K	2475 lm	399,95 €
342150	<input checked="" type="checkbox"/>	black mat		2700 K	2475 lm	399,95 €



BARREL

Full focus: The BARREL pendant luminaire concentrates entirely on its most important task - illuminating a specific area. This is not least due to the noble metal shade, which ensures glare-free lighting pleasure throughout.

The illuminant 180071 was used for the picture on the right.

BARREL

- metal
- dimensions L x Ø: 250 x 100 mm
- socket H x Ø: 25 x 120 mm
- max. suspension: 1000 mm
- dimmable via optional illuminants

342049  copper coloured **49,95 €**

342050  silver coloured satined **49,95 €**

342051  black **49,95 €**



suitable illuminants on page 974-977



BELL

- metal
- dimensions L x Ø: 300 x 300 mm
- socket H x Ø: 25 x 120 mm
- max. suspension: 1000 mm
- dimmable via optional illuminants

342052  copper coloured **99,95 €**

342053  silver coloured satined **99,95 €**

342054  black **99,95 €**



suitable illuminants on page 974-977







MEROPE

The pendant luminaires of the new MEROPE series combine timeless elegance and reduced modernity. Available in the diameters of 480 mm and 780 mm, the MEROPE series 192 or 360 warm white LEDs [3000 K] along the inside of the its slender, airy round shape and illuminates rooms with an astonishingly powerful 3000 or 5000 lumens. The outside is made of brushed aluminium in the colours of colours white, silver and coffee. We are sure that especially the latter colour scheme will set a new trend...



MEROPE 480MM

- timeless design
- high-quality workmanship
- high luminous intensity
- aluminium
- dimensions H x Ø: 35 x 480 mm
- socket H x Ø: 65 x 203 mm
- max. suspension: 1500 mm
- dimmable via leading or trailing edge

342152	<input type="checkbox"/>	Traffic white RAL 9016 sandblasted	3000 K	2990 lm	199,95 €
342153	<input type="checkbox"/>	silver coloured brushed	3000 K	2990 lm	199,95 €
342154	<input type="checkbox"/>	coffee brushed	3000 K	2990 lm	199,95 €

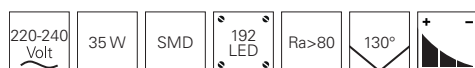

suitable
ceiling lights
page 99
348132
348133
348134



MEROPE 780MM

- timeless design
- high-quality workmanship
- high luminous intensity
- aluminium
- dimensions H x Ø: 35 x 780 mm
- max. suspension: 1535 mm
- dimmable via leading or trailing edge

342155	<input type="checkbox"/>	Traffic white RAL 9016 sandblasted	3000 K	5020 lm	369,95 €
342156	<input type="checkbox"/>	silver coloured brushed	3000 K	5020 lm	369,95 €
342157	<input type="checkbox"/>	coffee brushed	3000 K	5020 lm	369,95 €

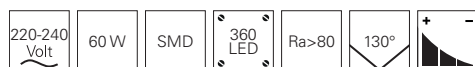

suitable
ceiling lights
page 99
348135
348136
348137

CENTAURI

Eye-catcher for any room - with the CENTAURI pendant luminaires in a chrome-plated silver look, you can give any room a modern design character. A total of seven aluminium spheres with GU10 light sources [max. 50 watts] form a unique luminaire structure above tables, work surfaces and other living objects, which is in no way inferior to the constellation that gives it its name in terms of fascination and effect.



CENTAURI I

- aluminium
- dimensions Ø: 130 mm
- socket H x Ø: 25 x 105 mm
- max. suspension: 1000 mm
- dimmable via optional illuminants

342097 white mat

49,95 €

342098 silver coloured chrome

49,95 €



suitable illuminants on page 969-970



suitable
ceiling lights
page 106
348088
348091





CENTAURI III

- aluminium
- dimensions Ø: 130 mm
- socket H x Ø: 25 x 105 mm
- max. suspension: 1000 mm
- dimmable via optional illuminants

342099  silver coloured chrome

129,95 €



suitable illuminants on page 969-970



suitable
ceiling light
page 107
348093



ANKAA

Step closer, risk a look: The ANKAA pendant luminaire is dominated by timeless metal, which is interrupted by horizontal light slits and in this way not only creates an extraordinary room light, but will also catch the eye of your guests.

The light sources 180060 for the small and 180061 for the large ANKAA were used for this photo.



ANKAA 200

- metal
- dimensions L x Ø: 1400 x 200 mm
- socket H x Ø: 25 x 120 mm
- max. suspension: 1175 mm
- dimmable via optional illuminants

342137  stainless steel brushed

79,95 €



suitable illuminants on page 974-977

ANKAA 280

- metal
- dimensions L x Ø: 1500 x 280 mm
- socket H x Ø: 25 x 120 mm
- max. suspension: 1195 mm
- dimmable via optional illuminants

342138  stainless steel brushed

119,95 €



suitable illuminants on page 974-977







FILO BALL

- metal
- dimensions H x Ø: 160 x 160 mm
- socket H x Ø: 25 x 100 mm
- max. suspension: 1200 mm
- dimmable via optional illuminants

342029  silver coloured **59,95 €**
342030  black **59,95 €**



suitable illuminants on page 978



FILO MOB

- metal
- dimensions H x Ø: 190 x 190 mm
- socket H x Ø: 25 x 100 mm
- max. suspension: 1200 mm
- dimmable via optional illuminants

342025  silver coloured **65,95 €**
342026  black **65,95 €**



suitable illuminants on page 974-977



FILO BIG MOB

- metal
- dimensions H x Ø: 300 x 300 mm
- socket H x Ø: 25 x 100 mm
- max. suspension: 1200 mm
- dimmable via optional illuminants

342027 silver coloured **139,95 €**
342028 black **139,95 €**



suitable illuminants on page 974-977



FILO SAT

- metal
- dimensions H x Ø: 180 x 390 mm
- socket H x Ø: 25 x 100 mm
- max. suspension: 1200 mm
- dimmable via optional illuminants

342031 silver coloured **139,95 €**
342032 black **139,95 €**



suitable illuminants on page 974-977

PAVONIS & CYGNI

Concrete - a timeless companion. In the meantime, the functional and visual advantages of this ubiquitous material have also reached the lighting industry. Due to the stability of concrete, even large luminaires can be built narrowly. Our PAVONIS & CYGNI models combine the timelessly modern concrete look with elegant brass or chrome surfaces.

For this photo, the light sources 180057 for the PAVONIS and 180062 for the CYGNI were used.

PAVONIS

- concrete
- dimensions H x Ø: 199 x 140 mm
- socket H x Ø: 25 x 120 mm
- max. suspension: 1500 mm
- dimmable via optional illuminants

342103  grey **59,95 €**
342104  dark grey **59,95 €**



suitable illuminants on page 974-977



CYGNI

- concrete
- dimensions H x Ø: 285 x 400 mm
- socket H x Ø: 25 x 120 mm
- max. suspension: 1500 mm
- dimmable via optional illuminants

342101  grey **109,95 €**
342102  dark grey **109,95 €**



suitable illuminants on page 974-977





POLARIS

- concrete
- dimensions L x W x H: 70 x 70 x 250 mm
- socket L x W x H: 80 x 80 x 30 mm
- max. suspension: 1200 mm
- dimmable via optional illuminants

342095  grey

59,95 €



suitable illuminants on page 969-970



POLLUX

- concrete
- dimensions H x Ø: 250 x 70 mm
- socket H x Ø: 35 x 90 mm
- max. suspension: 1200 mm
- dimmable via optional illuminants

342096  grey

59,95 €



suitable illuminants on page 969-970



CONCRETO I

- concrete
- dimensions H x Ø: 188 x 188 mm
- socket H x Ø: 25 x 120 mm
- max. suspension: 1600 mm
- dimmable via optional illuminants

342128  grey

65,95 €



suitable illuminants on page 974-977



BARRO II

- gypsum
- dimensions H x Ø: 250 x 70 mm
- socket H x Ø: 31 x 70 mm
- max. suspension: 1200 mm
- dimmable via optional illuminants

342024  white paintable

65,95 €



suitable illuminants on page 969-970





BASKET I

- gypsum
- dimensions H x Ø: 101 x 206 mm
- socket H x Ø: 25 x 100 mm
- max. suspension: 3000 mm
- dimmable via optional illuminants

342142 white

75,95 €



suitable illuminants on page 974-977



BASKET II

- gypsum
- dimensions H x Ø: 168 x 344 mm
- socket H x Ø: 25 x 120 mm
- max. suspension: 3000 mm
- dimmable via optional illuminants

342143 white

135,95 €



suitable illuminants on page 974-977



TWISTER

Elegant design with innovative details meets exceptional choice of materials: The TWISTER series combines decorative floor, table and pendant luminaires in different sizes, made entirely of plaster. We turn the cable into a design element! Entirely in classic white, the luminaires are only interrupted by a red cable. This makes the TWISTER series an eye-catcher not only in living areas, but also in hotels or restaurants.

TWISTER I

• Design by Johannes Tomm

• red textile power cable

- gypsum
- easy cleaning through surface treatment
- dimensions H x Ø: 185 x 180 mm
- socket H x Ø: 25 x 120 mm
- max. suspension: 3000 mm
- dimmable via optional illuminants

342144 white

109,95 €



suitable illuminants on page 972



suitable
table /
floor lights
page 218
346010
343017

TWISTER II

• Design by Johannes Tomm

• red textile power cable

- gypsum
- easy cleaning through surface treatment
- dimensions H x Ø: 282 x 280 mm
- socket H x Ø: 25 x 120 mm
- max. suspension: 3000 mm
- dimmable via optional illuminants

342145 white

159,95 €



suitable illuminants on page 974-977



suitable
table /
floor lights
page 218
346010
343017



BUNDA

- glass
- dimensions Ø: 135 mm
- socket H x Ø: 25 x 100 mm
- max. suspension: 1200 mm
- dimmable via optional illuminants

342114  silver coloured chrome

55,95 €



suitable illuminants on page 978



BUNDA

- glass
- dimensions Ø: 135 mm
- socket L x W x H: 610 x 75 x 25 mm
- max. suspension: 1200 mm
- dimmable via optional illuminants

342115  silver coloured chrome

129,95 €



suitable illuminants on page 978



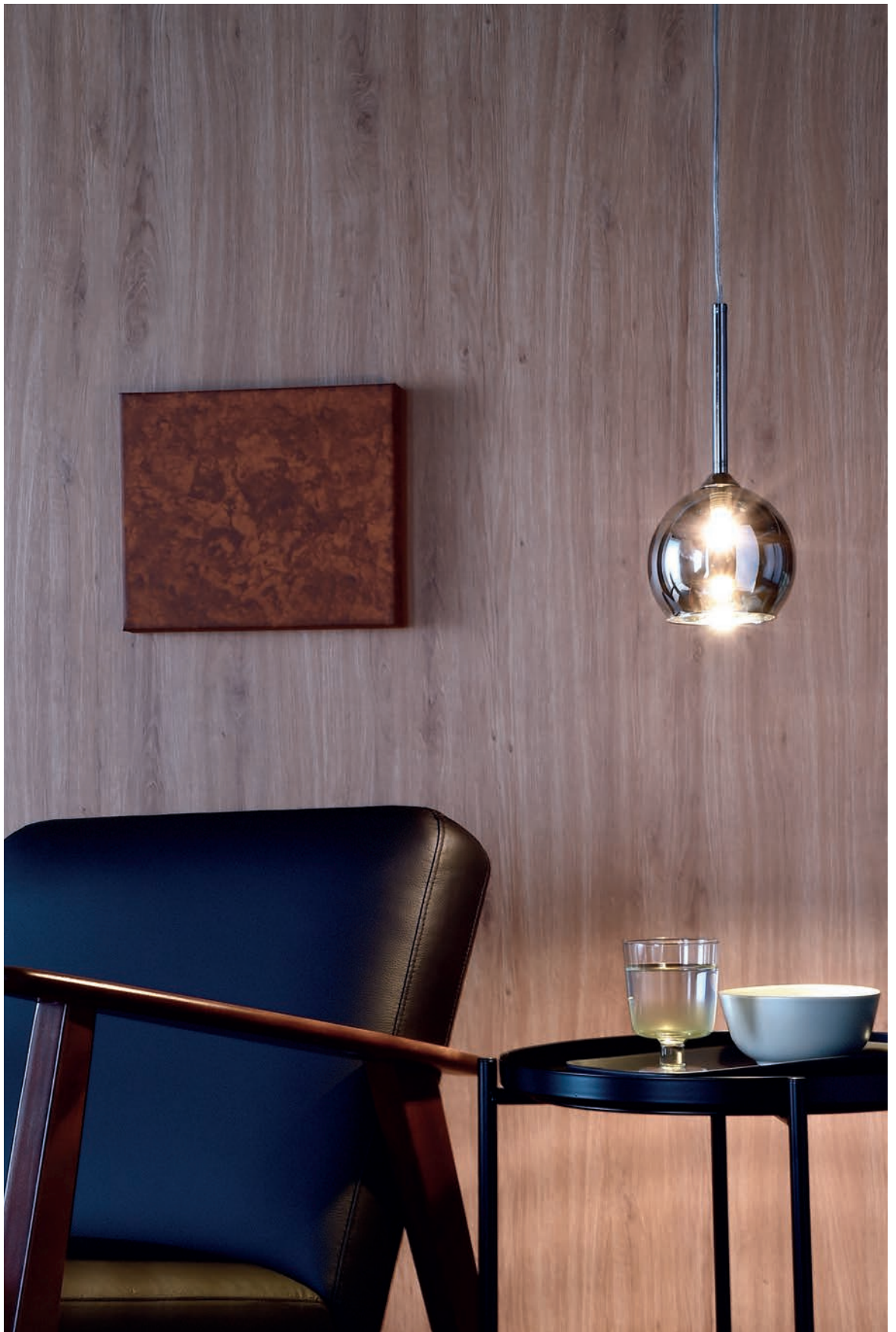

KSORA

Transparent and yet full of life: The exclusive KSORA pendant luminaire uses three glass shades in a noble crystal look and provides stylish lighting for tables, bar areas and lounges. It doesn't always have to be cognac or champagne, but a little sparkle never hurt any surroundings.

The 180084 lamp was used for this photo.

KSORA

- glass
- dimensions Ø: 120 mm
- socket H x Ø: 25 x 100 mm
- max. suspension: 1200 mm
- dimmable via optional illuminants

342112  colourless transparent

55,95 €



suitable illuminants on page 978



KSORA

- glass
- dimensions Ø: 120 mm
- socket L x W x H: 610 x 75 x 25 mm
- max. suspension: 1200 mm
- dimmable via optional illuminants

342113  colourless transparent

129,95 €



suitable illuminants on page 978





DIPHDA

Bring the Orient into your home: Are you looking for the final eye-catcher to add the finishing touch to your dignified modern retro interior? With its copper-coloured surface, the DIPHDA sets cultivated light accents that cut an excellent figure in bars and lounges as well as in living areas.

The light sources 180054 for the small and 180060 for the large DIPHDA were used for this photo.

DIPHDA

- glass
- dimensions H x Ø: 1200 x 150 mm
- socket H x Ø: 25 x 100 mm
- max. suspension: 1200 mm
- dimmable via optional illuminants

342118  silver coloured chrome

55,95 €

342120  copper coloured

55,95 €



suitable illuminants on page 974-977



DIPHDA

- glass
- dimensions H x Ø: 1200 x 200 mm
- socket H x Ø: 25 x 100 mm
- max. suspension: 1200 mm
- dimmable via optional illuminants

342119  silver coloured chrome

65,95 €

342121  copper coloured

65,95 €



suitable illuminants on page 974-977



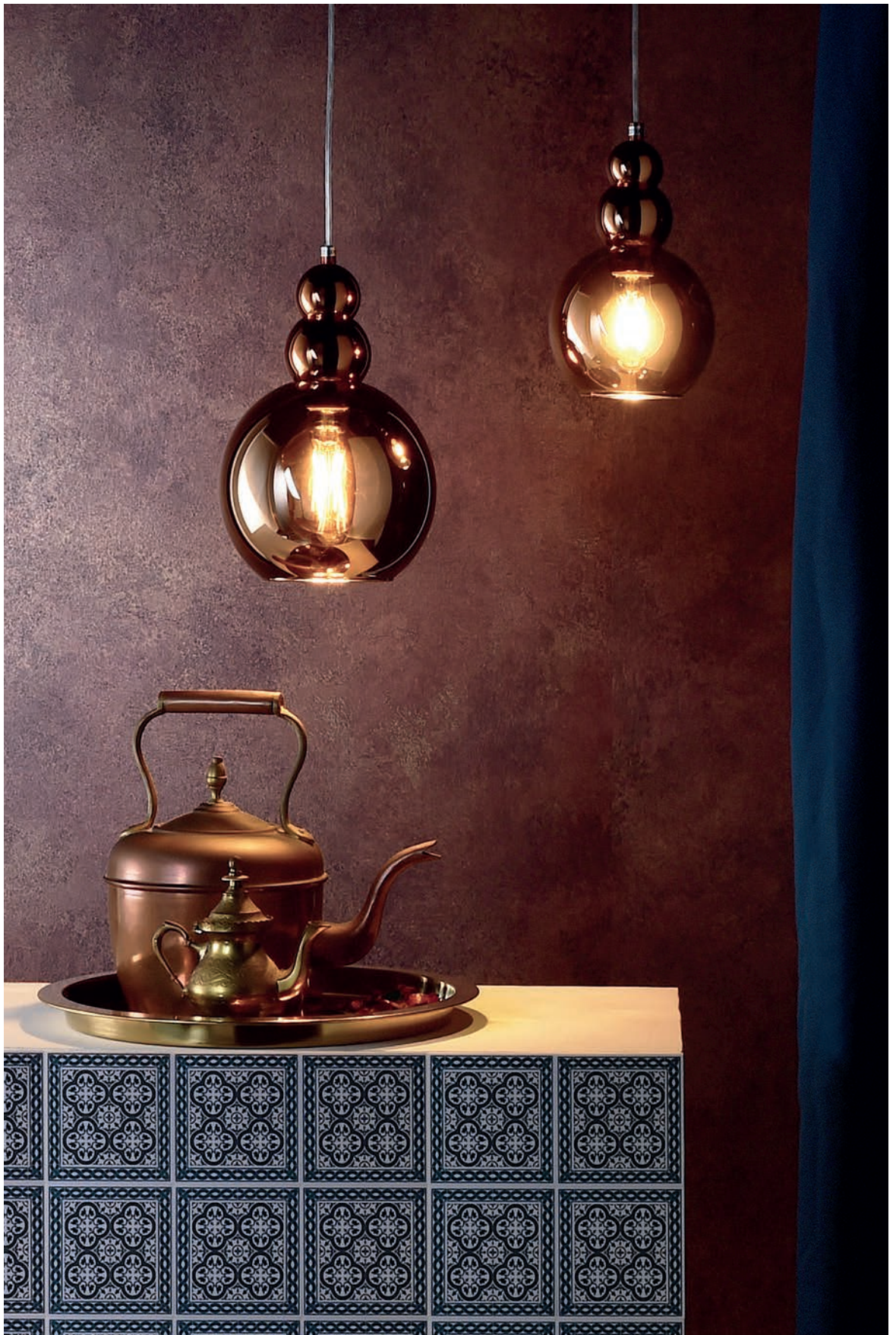

ELECTRA

Could it be any cooler? Sure - ELECTRA! The combination of silver-coloured chrome lampshade and modern LED technology underlines modern interiors and serves as an elegant eye-catcher above tables and other furniture.

But don't worry: with its warm light colour, ELECTRA creates a cosy, warm atmosphere.



ELECTRA

- glass
- dimensions Ø: 115 mm
- socket H x Ø: 25 x 100 mm
- max. suspension: 1200 mm
- dimmable via leading or trailing edge

342116 silver coloured chrome  3000 K 180 lm **89,95 €**



ELECTRA

- glass
- dimensions Ø: 115 mm
- socket L x W x H: 610 x 75 x 25 mm
- max. suspension: 1200 mm
- dimmable via leading or trailing edge

342117 silver coloured chrome  3000 K 540 lm **189,95 €**







CLARA

Simple elegance - the CLARA LED pendant luminaire with its chrome-plated base and double shade made of clear [outside] and satinised [inside] glass adds a fresh sparkle to any counter or table. The 5 watt LED with 3000K can be dimmed via phase on or phase off.



CLARA

- glass
- dimensions H x Ø: 206 x 113 mm
- socket H x Ø: 35 x 120 mm
- max. suspension: 1000 mm
- dimmable via leading or trailing edge

342086  colourless satined  3000 K 370 lm **109,95 €**

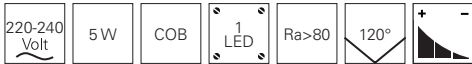



FURNEL

The world in a sphere - the FURNEL pendant luminaire fills your room with a pleasant light and reflects the surroundings via its mirrored glass surface. Room and luminaire can hardly be brought together in a more natural way.



in the off-state

in the on-state

FURNEL

- glass
- dimensions Ø: 350 mm
- socket H x Ø: 25 x 100 mm
- max. suspension: 1200 mm
- dimmable via optional illuminants

342109  silver coloured mirrored

129,95 €



suitable illuminants on page 974-977





ELENA

Interesting real glass shade - The suspension of the ELENA LED pendant luminaire is a maximum of 1.2 metres and, with its chrome-plated base and double shade in the shape of a teardrop, made of clear [outside] and satinised [inside] glass, lends a fresh shine to any counter or table. The 5 watt LED with warm white light colour can be dimmed via phase on or phase off.



ELENA

- glass
- dimensions H x Ø: 171 x 110 mm
- socket H x Ø: 35 x 120 mm
- max. suspension: 1200 mm
- dimmable via leading or trailing edge

342087  colourless satined  2700 K 290 lm **165,95 €**

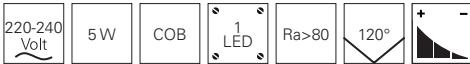



MADERA

The MADERA series is made of first-class European oak wood and impresses with its modern design and mix of materials in private living areas, hotels, restaurants and much more. The noble MADERA luminaires distribute their powerful warm white light in every room and thus also cut an excellent figure as functional and high-quality lighting at reception counters and co.



touch sensor



suitable
ceiling light
page 113
348147



suitable
wall light
page 194
341248



suitable
table /
floor lights
page 220
346044
343031

MADERA

- modern, exclusive design
- made in Europe from high-quality oak wood of quality class A
- FSC-certified raw material oak wood
- environmentally friendly packaging
- infinitely dimmable via discreet, laterally touch sensor on the side
- oak wood | aluminium
- dimensions L x W x H: 900 x 40 x 60 mm
- socket L x W x H: 370 x 50 x 30 mm
- max. suspension: 1000 mm

342169 ■ wood, black ■ 3000 K 1190 lm **365,95 €**

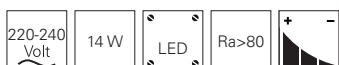





□ □
page 90



□ □ □ □
□ □ □ □
page 93



□ □ □ □
□ □ □ □
page 94



□ □ □ □
□ □ □ □
page 95



□ □ □
page 96



□ □ □
page 99



□ □ □
page 99



□
page 100



□
page 100



□
page 101



□
page 102



□
page 102



□
page 103



□
page 104



□
page 104



□
page 105



□ □
page 106



□ □
page 106



□ □
page 107

surface mounted ceiling lights



□ □ ■
page 108



□ □ ■
page 108



□ ■
page 109



□ ■
page 109



□
page 110



■
page 111



■
page 111



■
page 113

ORBIT

The ORBIT is a modern surface-mounted ceiling luminaire that offers more than is apparent at first glance. In addition to its high light output [optionally in warm white or neutral white] and a 360° beam angle for perfect area illumination, the ORBIT can be converted into a chic pendant luminaire via an optional wire suspension. For those who need even more flexibility, the ORBIT can be combined with the ZANIAH series, which is also new.



ORBIT

- modern design
- high luminous intensity
- 360° beam angle
- can be converted into a pendant luminaire
- can be combined with the ZANIAH series
- plastic
- dimensions H x Ø: 45 x 350 mm
- socket H x Ø: 40 x 200 mm
- dimmable via leading or trailing edge

401009	<input type="checkbox"/>	white milky	<input checked="" type="checkbox"/> ww	3000 K	1650 lm	169,95 €
401010	<input type="checkbox"/>	white milky	<input checked="" type="checkbox"/> nw	4000 K	1760 lm	169,95 €

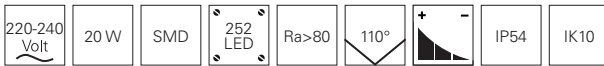

optional accessories

930647	<input type="checkbox"/>	canopy with rope suspension	19,95 €
---------------	--------------------------	-----------------------------	----------------

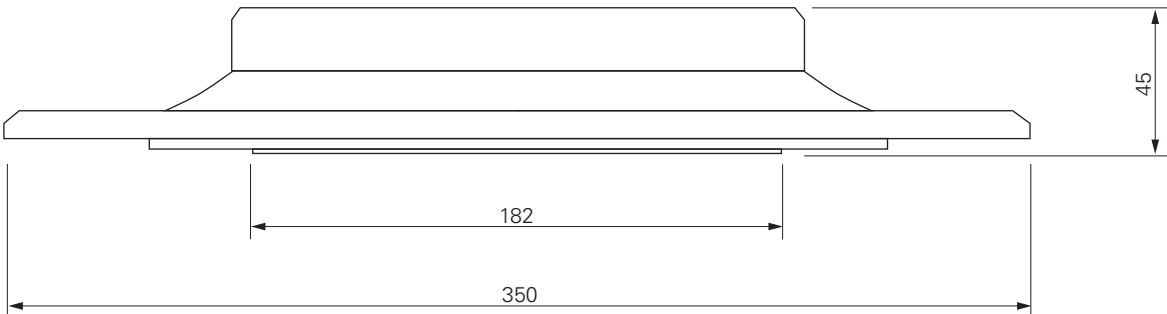





















ZANIAH

While most surface-mounted ceiling luminaires focus on flat surfaces and covers, the ZANIAH deliberately places its 360° light source [optionally available as 12W, 18W and 24W versions] in the foreground. This is not only for optical reasons, because the ZANIAH can be combined with the covers of the ORBIT series, which is also new. In this way, not only are different RAL colours available – the ZANIAH itself is also available in eight colour variants per power class.



ZANIAH 12W

- modern design
- interchangeable covers in RAL colours
- 360° beam angle
- aluminium
- dimensions H x Ø: 42 x 290 mm
- dimmable via leading or trailing edge

620040		Pure white RAL 9010		ww 3000 K	1500 lm	105,95 €
620033		silver coloured		ww 3000 K	1500 lm	105,95 €
620038		Basalt grey RAL 7012		ww 3000 K	1500 lm	105,95 €
620039		Jet black RAL 9005		ww 3000 K	1500 lm	105,95 €
620036		Ruby red RAL 3003		ww 3000 K	1500 lm	105,95 €
620037		Saffron yellow RAL 1017		ww 3000 K	1500 lm	105,95 €
620034		Cobalt blue RAL 5013		ww 3000 K	1500 lm	105,95 €
620035		Leaf green RAL 6002		ww 3000 K	1500 lm	105,95 €

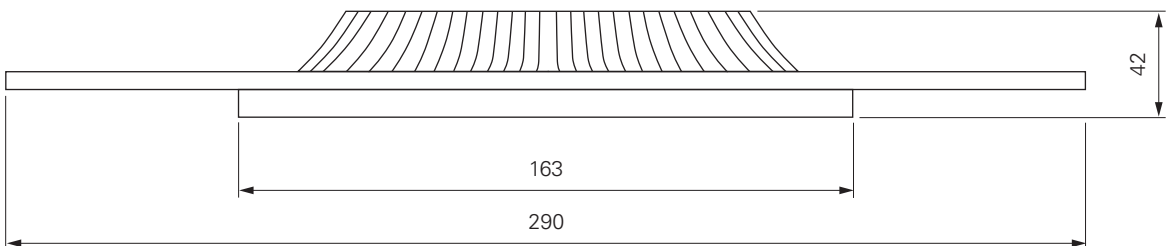



ZANIAH 18W

- modern design
- interchangeable covers in RAL colours
- 360° beam angle
- aluminium
- dimensions H x Ø: 46 x 370 mm
- dimmable via leading or trailing edge



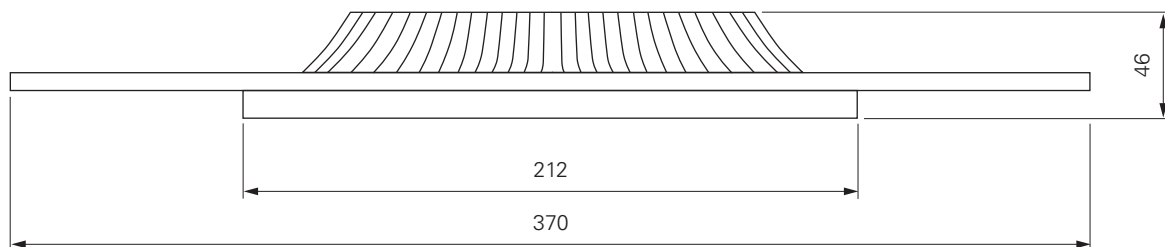













620048		Pure white RAL 9010		3000 K	2000 lm	115,95 €
620041		silver coloured		3000 K	2000 lm	115,95 €
620046		Basalt grey RAL 7012		3000 K	2000 lm	115,95 €
620047		Jet black RAL 9005		3000 K	2000 lm	115,95 €
620044		Ruby red RAL 3003		3000 K	2000 lm	115,95 €
620045		Saffron yellow RAL 1017		3000 K	2000 lm	115,95 €
620042		Cobalt blue RAL 5013		3000 K	2000 lm	115,95 €
620043		Leaf green RAL 6002		3000 K	2000 lm	115,95 €





ZANIAH 24W

- modern design
- interchangeable covers in RAL colours
- 360° beam angle
- aluminium
- dimensions H x Ø: 46 x 420 mm
- dimmable via leading or trailing edge

620056		Pure white RAL 9010		ww 3000 K	2560 lm	125,95 €
620049		silver coloured		ww 3000 K	2560 lm	125,95 €
620054		Basalt grey RAL 7012		ww 3000 K	2560 lm	125,95 €
620055		Jet black RAL 9005		ww 3000 K	2560 lm	125,95 €
620052		Ruby red RAL 3003		ww 3000 K	2560 lm	125,95 €
620053		Saffron yellow RAL 1017		ww 3000 K	2560 lm	125,95 €
620050		Cobalt blue RAL 5013		ww 3000 K	2560 lm	125,95 €
620051		Leaf green RAL 6002		ww 3000 K	2560 lm	125,95 €

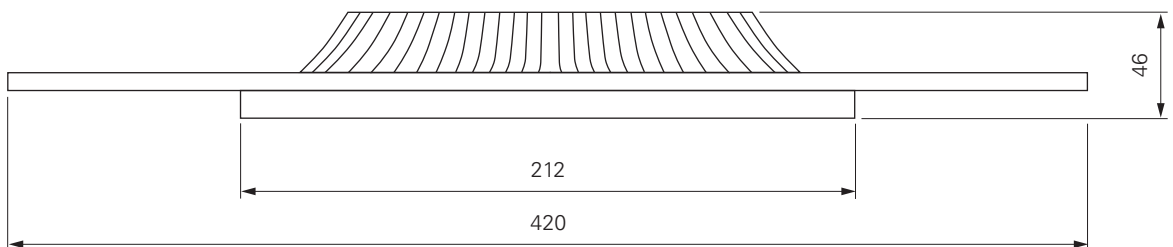



MENKAR

The surface-mounted ceiling luminaires of the MENKAR series can be perfectly combined with the MIRACH luminaires – after all, they come from the same luminaire family. Like the MIRACH and the MEROPE, the MENKAR also relies on the elegant outer aluminium ring in white, silver or coffee finishes. In addition, the MENKAR has a rear light with an independent power supply unit. In this way, corridors can be provided with discreet indirect light throughout, while the main light is only switched on when necessary [e.g. by a motion detector].



MENKAR

- **separately switchable backlight, 7W**
[in combination with a series switch]
- **timeless design**
- **high luminous intensity**
- aluminium
- dimensions H x Ø: 90 x 400 mm
- dimmable via leading or trailing edge

348129	<input type="checkbox"/>	Traffic white RAL 9016 sandblasted	<input type="checkbox"/>	3000 K	3460 lm	159,95 €
348130	<input type="checkbox"/>	silver coloured brushed	<input type="checkbox"/>	3000 K	3460 lm	159,95 €
348131	<input type="checkbox"/>	coffee brushed	<input type="checkbox"/>	3000 K	3460 lm	159,95 €









MIRACH

The timeless MIRACH impresses with its high luminous intensity and low installation height, as well as it is also a real visual eye-catcher thanks to the elegant outer aluminum ring - which is available in sandblasted white, in a brushed finish in silver or the trendy color coffee. Available in diameters of 380 mm and 580 mm, MIRACH can be integrated even more flexibly into a wide variety of environments.



MIRACH 380 MM

- timeless design
- low installation height
- high luminous intensity
- aluminium
- dimensions H x Ø: 60 x 380 mm
- dimmable via leading or trailing edge

348132	<input type="checkbox"/>	white sandblasted		3000 K	2700 lm	139,95 €
348133	<input type="checkbox"/>	silver coloured brushed		3000 K	2700 lm	139,95 €
348134	<input type="checkbox"/>	coffee brushed		3000 K	2700 lm	139,95 €

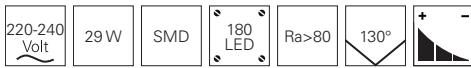



suitable
pendant lights
page 55
342152
342153
342154



MIRACH 580 MM

- timeless design
- low installation height
- high luminous intensity
- aluminium
- dimensions H x Ø: 60 x 580 mm
- dimmable via leading or trailing edge

348135	<input type="checkbox"/>	white sandblasted		3000 K	4365 lm	229,95 €
348136	<input type="checkbox"/>	silver coloured brushed		3000 K	4365 lm	229,95 €
348137	<input type="checkbox"/>	coffee brushed		3000 K	4365 lm	229,95 €

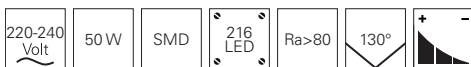

suitable
pendant lights
page 55
342155
342156
342157



LIBRAE LINEAR I

- aluminium
- dimensions L x W x H x Ø: 122 x 72 x 110 x 65 mm
- socket L x W x H: 122 x 72 x 30 mm
- dimmable via optional illuminants

348073 white mat **35,95 €**



suitable illuminants on page 969-970

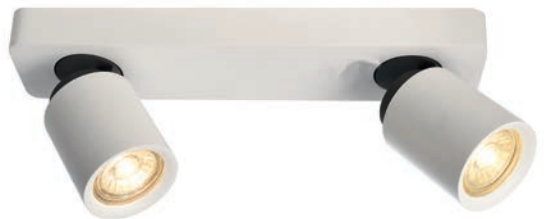

LIBRAE LINEAR II

- aluminium
- dimensions L x W x H x Ø: 322 x 72 x 110 x 65 mm
- socket L x W x H: 322 x 72 x 30 mm
- dimmable via optional illuminants

348074 white mat **65,95 €**



suitable illuminants on page 969-970



LIBRAE LINEAR III

- aluminium
- dimensions L x W x H x Ø: 542 x 72 x 110 x 65 mm
- socket L x W x H: 542 x 72 x 30 mm
- dimmable via optional illuminants

348075 white mat

99,95 €



suitable illuminants on page 969-970

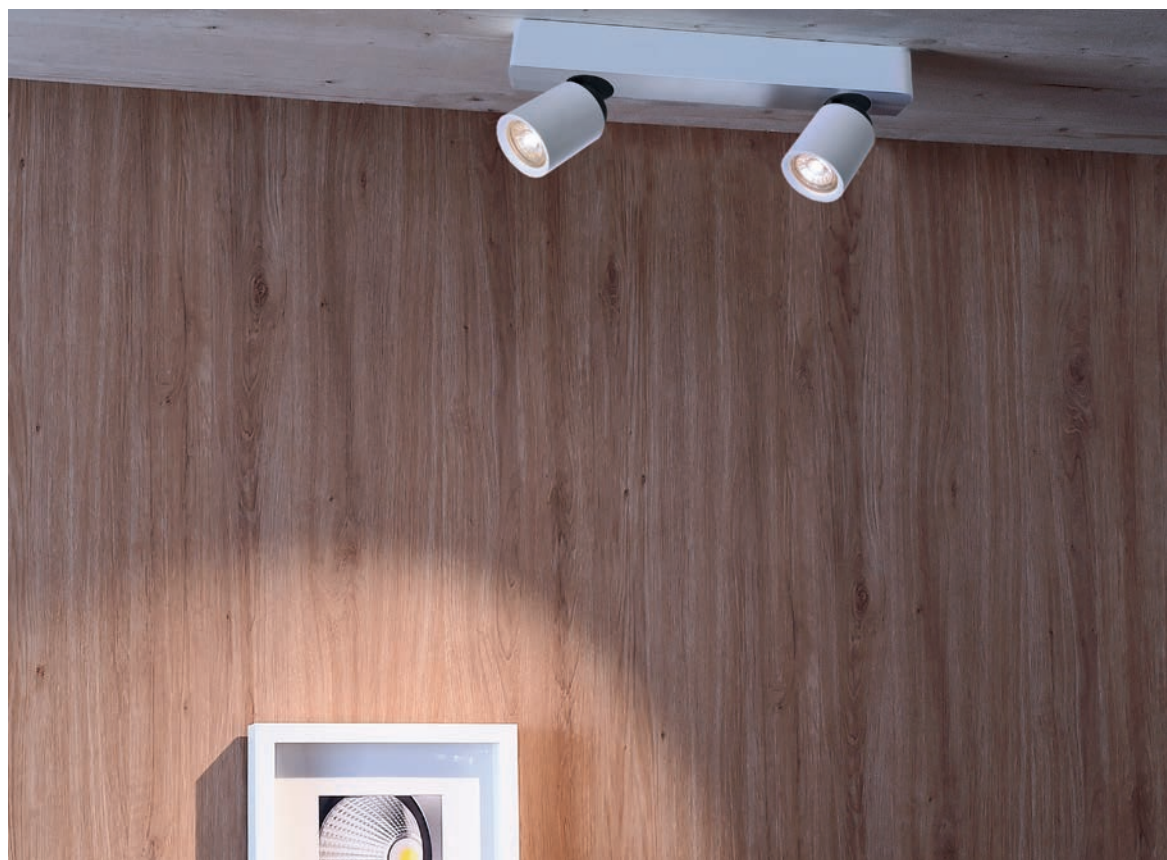



LIBRAE ROUND I

- aluminium
- dimensions H x Ø: 110 x 65 mm
- socket H x Ø: 30 x 102 mm
- dimmable via optional illuminants

348076 white mat **35,95 €**



suitable illuminants on page 969-970



LIBRAE ROUND II

- aluminium
- dimensions H x Ø: 110 x 65 mm
- socket H x Ø: 30 x 173 mm
- dimmable via optional illuminants

348077 white mat **65,95 €**



suitable illuminants on page 969-970



LIBRAE ROUND III

- aluminium
- dimensions H x Ø: 110 x 65 mm
- socket H x Ø: 30 x 212 mm
- dimmable via optional illuminants

348078 white mat

99,95 €



suitable illuminants on page 969-970





INDI I

- aluminium
- dimensions H x Ø: 124 x 100 mm
- socket H x Ø: 25 x 80 mm
- dimmable via optional illuminants

348085  silver coloured brushed

29,95 €



suitable illuminants on page 969-970



INDI II

- aluminium
- dimensions H x Ø: 124 x 172 mm
- socket H x Ø: 25 x 135 mm
- dimmable via optional illuminants

348086  silver coloured brushed

49,95 €



suitable illuminants on page 969-970



INDI III

- aluminium
- dimensions H x Ø: 124 x 250 mm
- socket H x Ø: 25 x 190 mm
- dimmable via optional illuminants

348087 silver coloured brushed

69,95 €



suitable illuminants on page 969-970





CENTAURI I

- aluminium
- dimensions H x Ø: 186 x 130 mm
- socket H x Ø: 25 x 105 mm
- dimmable via optional illuminants

348088 white mat **49,95 €**
348091 silver coloured chrome **49,95 €**



suitable illuminants on page 969-970



suitable
pendant lights
page 56
342097
342098



CENTAURI II

- aluminium
- dimensions L x W x H x Ø: 350 x 130 x 186 x 110 mm
- socket L x W x H: 320 x 100 x 30 mm
- dimmable via optional illuminants

348089 white mat **89,95 €**
348092 silver coloured chrome **89,95 €**



suitable illuminants on page 969-970



CENTAURI III

- aluminium
- dimensions L x W x H x Ø: 570 x 130 x 186 x 110 mm
- socket L x W x H: 540 x 100 x 30 mm
- dimmable via optional illuminants

348090 white mat **129,95 €**

348093 silver coloured chrome **129,95 €**



suitable illuminants on page 969-970



suitable
pendant light
page 58
342099



BENGALA

- aluminium
- dimensions H x Ø: 120 x 96 mm
- socket Ø: 96 mm
- dimmable via optional illuminants

348023	<input type="checkbox"/> white	45,95 €
122416	<input type="checkbox"/> silver coloured brushed	45,95 €
348022	<input type="checkbox"/> black	45,95 €



suitable illuminants on page 969-970

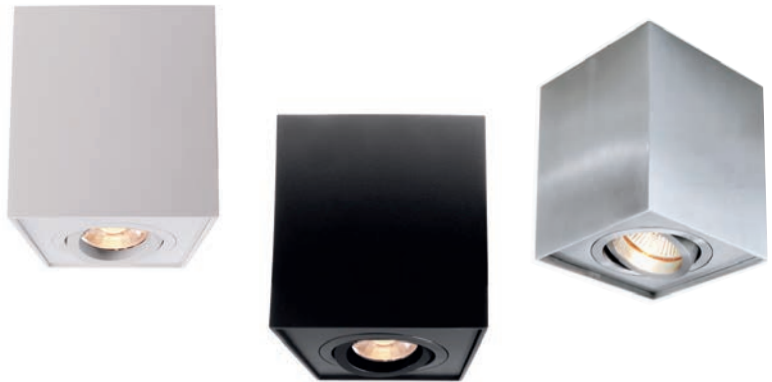

DATO

- aluminium
- dimensions L x W x H: 96 x 96 x 120 mm
- socket L x W: 96 x 96 mm
- dimmable via optional illuminants

348025	<input type="checkbox"/> white	45,95 €
122417	<input type="checkbox"/> silver coloured brushed	45,95 €
348024	<input type="checkbox"/> black	45,95 €



suitable illuminants on page 969-970



MONA I

- aluminium diecast
- dimensions L x W x H: 93 x 93 x 120 mm
- dimmable via optional illuminants

348001 white **55,95 €**

348002 black **55,95 €**



suitable illuminants on page 969-970



MONA II

- aluminium diecast
- dimensions L x W x H: 186 x 93 x 120 mm
- dimmable via optional illuminants

348004 white **109,95 €**

348005 black **109,95 €**



suitable illuminants on page 969-970



SKY LED

- aluminium
- dimensions L x W x H: 105 x 105 x 105 mm
- trailing edge

348013 white 3000 K 770 lm **125,95 €**





NAOS I

- concrete
- dimensions L x W x H: 70 x 70 x 112 mm
- socket L x W x H: 60 x 40 x 45 mm
- dimmable via optional illuminants

348048  grey

75,95 €



suitable illuminants on page 969-970



NAOS II

- concrete
- dimensions H x Ø: 112 x 70 mm
- socket L x W x H: 60 x 40 x 45 mm
- dimmable via optional illuminants

348049  grey

75,95 €



suitable illuminants on page 969-970



MADERA

The MADERA series is made of first-class European oak wood and impresses with its modern design and mix of materials in private living areas, hotels, restaurants and many more. The noble MADERA luminaires distribute their powerful warm white light in any room and thus also cut an excellent figure as functional and high-quality lighting at reception counters and more.



suitable
pendant light
page 86
342169



suitable
wall light
page 194
341248



suitable
table /
floor lights
page 220
346044
343031

MADERA

- modern, exclusive design
- manufactured in Europe
from high-quality oak wood of grade A
- FSC-certified raw material oak wood
- environmentally friendly packaging
- oak wood | aluminium
- dimensions L x W x H: 810 x 135 x 110 mm
- socket L x W x H: 250 x 135 x 30 mm

348147 ■ wood, black  3000 K 1120 lm **375,95 €**





□ □ □
page 118



□ □ □
page 118



□ □ □
□ □ □
page 120



□ □ □
page 120



□ □ □
page 121



□
page 121



□ □ □
page 122



□ □
page 123



□ □
page 123



□ □ □
page 124



□
Seite 125



□
Seite 125



□
Seite 126



□
page 162



□
Seite 127



■
page 128



□
page 129



□ □
page 129



□
page 130



□
page 130



□ □
page 131



□ □
page 131



□
page 132



□
page 132

built in ceiling lights



page 133



page 133



page 134



page 134



page 135



page 135



page 136



page 136



page 137



page 137

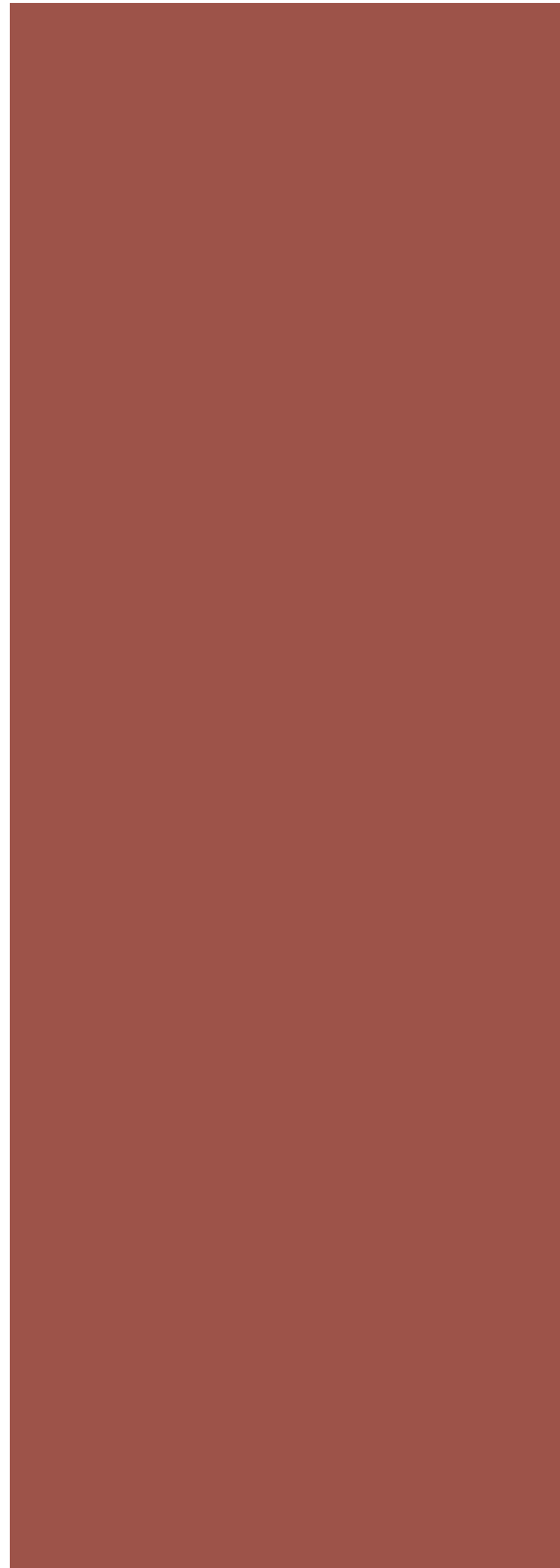



☐☐☐
page 140



☐☐☐
page 140



☐☐☐
page 141



☐
page 142



☐
page 142



☐☐☐
page 144



☐☐
page 144



☐☐
page 145



☐
page 145



☐☐
page 146



☐☐
page 146



☐☐
page 147



☐☐☐
page 148



☐☐☐
page 149



☐☐☐
page 149



☐☐☐
page 150



☐
page 151



☐
page 151



☐☐☐
page 152



☐☐☐
page 153



☐☐☐
page 153



☐☐☐
page 154



☐☐☐
page 154



☐☐☐
page 155



□ □
page 155



□ □
page 156



□ □ □ □
page 157



□
page 158



□ □ □
page 159



CEILING BUILT-IN RING

- metal
- dimensions H x Ø: 30 x 80 mm
- dimmable via optional illuminants

442051	<input type="checkbox"/>	Signal white RAL 9003	3,95 €
442052	<input type="checkbox"/>	silver coloured chrome	3,95 €
442058	<input type="checkbox"/>	silver coloured brushed	3,95 €



suitable illuminants on page 967-968



CEILING BUILT-IN RING

- aluminium diecast
- dimensions H x Ø: 25 x 77 mm
- dimmable via optional illuminants

120017	<input type="checkbox"/>	Signal white RAL 9003	7,95 €
120018	<input type="checkbox"/>	silver coloured chrome	7,95 €
120020	<input type="checkbox"/>	silver coloured brushed	7,95 €



suitable illuminants on page 967-968





CEILING BUILT-IN RING

- metal
- dimensions Ø: 89 mm
- dimmable via optional illuminants

686868	<input type="checkbox"/>	Traffic white RAL 9016	7,95 €
686869	<input type="checkbox"/>	silver coloured chrome	7,95 €
686871	<input type="checkbox"/>	silver coloured brushed	7,95 €
686880	<input type="checkbox"/>	White aluminium RAL 9006 mat	7,95 €
686867	<input type="checkbox"/>	copper coloured	7,95 €
686864	<input type="checkbox"/>	Signal black RAL 9004 mat	7,95 €



suitable illuminants on page 967-968



CEILING BUILT-IN RING

- aluminium diecast
- dimensions H x Ø: 27 x 81 mm
- dimmable via optional illuminants

449200	<input type="checkbox"/>	Signal white RAL 9003	11,95 €
449201	<input type="checkbox"/>	silver coloured chrome	11,95 €
449202	<input type="checkbox"/>	silver coloured brushed	11,95 €



suitable illuminants on page 967-968



CEILING BUILT-IN RING

- metal
- dimensions H x Ø: 22 x 94 mm
- dimmable via optional illuminants

442831	<input type="checkbox"/>	Signal white RAL 9003	5,95 €
442832	<input type="checkbox"/>	silver coloured chrome	5,95 €
442838	<input type="checkbox"/>	silver coloured brushed	5,95 €

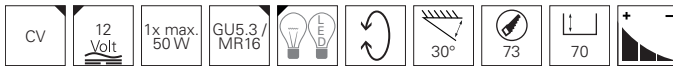

suitable illuminants on page 967-968



CEILING BUILT-IN RING

- aluminium
- dimensions H x Ø: 26 x 92 mm
- dimmable via optional illuminants

110222	<input type="checkbox"/>	silver coloured mat	16,95 €
---------------	--------------------------	---------------------	----------------

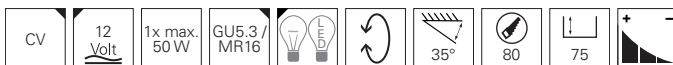

suitable illuminants on page 967-968



CEILING BUILT-IN RING

- aluminium diecast
- dimensions L x W x H: 82 x 82 x 27 mm
- dimmable via optional illuminants

449210	<input type="checkbox"/>	Signal white RAL 9003	11,95 €
449211	<input type="checkbox"/>	silver coloured chrome	11,95 €
449212	<input type="checkbox"/>	silver coloured brushed	11,95 €

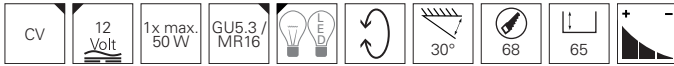

suitable illuminants on page 967-968



With the kind support of Göbel's Schlosshotel / 36289 Friedewald



ALIOTH ROUND

- aluminium diecast
- dimensions Ø: 83 mm
- dimmable via optional illuminants

110023 Signal white RAL 9003 **15,95 €**

110024 silver coloured **15,95 €**

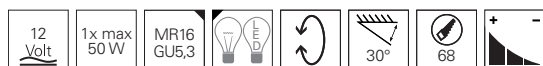

suitable illuminants on page 967-968



ALIOTH ANGULAR

- aluminium diecast
- dimensions L x W : 90 x 90 mm
- dimmable via optional illuminants

110025 Signal white RAL 9003 **15,95 €**

110026 silver coloured **15,95 €**

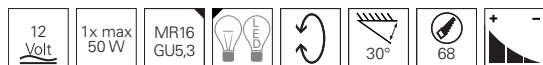

suitable illuminants on page 967-968



CEILING BUILT-IN RING

- aluminium diecast
- dimensions H x Ø: 42 x 84 mm
- dimmable via optional illuminants

110000	<input type="checkbox"/>	Signal white RAL 9003	18,95 €
110001	<input type="checkbox"/>	silver coloured mat	18,95 €
110002	<input type="checkbox"/>	silver coloured chrome	18,95 €



suitable illuminants on page 967-968





ALGOL I

- aluminium diecast
- dimensions L x W x H: 100 x 100 x 40 mm
- dimmable via optional illuminants

110003 Signal white RAL 9003

15,95 €

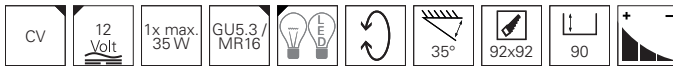

suitable illuminants on page 967-968



ALGOL II

- aluminium diecast
- dimensions L x W x H: 185 x 100 x 40 mm
- dimmable via optional illuminants

110004 Signal white RAL 9003

30,95 €

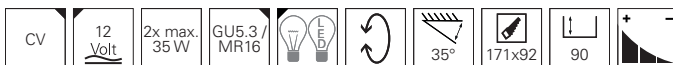

suitable illuminants on page 967-968



AUVA ANGULAR

- aluminium diecast
- dimensions L x W x H: 90 x 90 x 43 mm
- dimmable via optional illuminants

110006 Signal white RAL 9003 mat

11,95 €

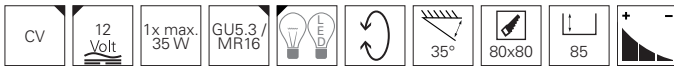

suitable illuminants on page 967-968



ENIF

- aluminium diecast
- dimensions H x Ø: 40 x 100 mm
- dimmable via optional illuminants

110007 Signal white RAL 9003

15,95 €

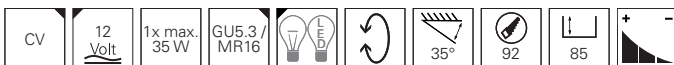

suitable illuminants on page 967-968



MIZAR I

- aluminium diecast
- dimensions H x Ø: 41 x 85 mm
- dimmable via optional illuminants

110010 Signal white RAL 9003 mat

16,95 €



suitable illuminants on page 967-968

With the kind support of Altherme Waldbrunn / Ziegler Technics buero@zieglertechnics.de



MIZAR II

- aluminium diecast
- dimensions H x Ø: 33 x 80 mm
- dimmable via optional illuminants



110011 ■ black mat

16,95 €



suitable illuminants on page 967-968



accessories

930079	cover angular metal silver satined 83 x 83 x 4 mm	9,95 €
930075	cover angular metal white mat 83 x 83 x 4 mm	9,95 €
930077	cover angular metal chrome look 83 x 83 x 4 mm	9,95 €
930100	cover angular metal silver brushed 83 x 83 x 4 mm	9,95 €
930078	cover round metal silver satined 83 x 4 mm	9,95 €
930074	cover round metal white mat 83 x 4 mm	9,95 €
930076	cover round metal chrome look 83 x 4 mm	9,95 €
930099	cover round metal silver brushed 83 x 4 mm	9,95 €
180515	power supply dimmable 12V AC 0-70 W	14,95 €



ALCOR

- stainless steel
- dimensions H x Ø: 8 x 85 mm
- dimmable via optional illuminants

110014 silver coloured brushed

16,95 €

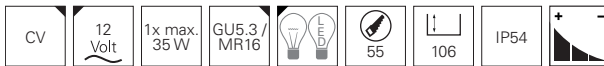

suitable illuminants on page 967-968



DENEb

- metal
- dimensions Ø: 100 mm
- dimmable via optional illuminants

110015 Traffic white RAL 9016

14,95 €

110016 silver coloured brushed

14,95 €



suitable illuminants on page 969-970



ALTAIR ROUND

- aluminium diecast
- dimensions H x Ø: 35 x 85 mm
- dimmable via optional illuminants

110017 Signal white RAL 9003

11,95 €



suitable illuminants on page 967-968



ALTAIR ANGULAR

- aluminium diecast
- dimensions L x W x H: 85 x 85 x 35 mm
- dimmable via optional illuminants

110018 Signal white RAL 9003

11,95 €



suitable illuminants on page 967-968



ARKTUR

- aluminium diecast
- dimensions H x Ø: 43 x 93 mm
- dimmable via optional illuminants

- | | | | | |
|---------------|--------------------------|-----------------------|---------|----------------|
| 110019 | <input type="checkbox"/> | Signal white RAL 9003 | round | 15,95 € |
| 110020 | <input type="checkbox"/> | Signal white RAL 9003 | angular | 15,95 € |



suitable illuminants on page 967-968



SIRRAH

- aluminium diecast
- dimensions H x Ø: 35 x 92 mm
- dimmable via optional illuminants

- | | | | | |
|---------------|--------------------------|-----------------------|---------|----------------|
| 110021 | <input type="checkbox"/> | Signal white RAL 9003 | round | 18,95 € |
| 110022 | <input type="checkbox"/> | Signal white RAL 9003 | angular | 18,95 € |



suitable illuminants on page 967-968



KARDAN I

- aluminium
- dimensions L x W x H: 98 x 98 x 90 mm
- dimmable via optional illuminants

110100  silver coloured brushed

25,95 €

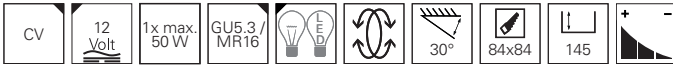

suitable illuminants on page 967-968



KARDAN II

- aluminium
- dimensions L x W x H: 178 x 98 x 90 mm
- dimmable via optional illuminants

110101  silver coloured brushed

45,95 €



suitable illuminants on page 967-968



CEILING BUILT-IN RING

- aluminium
- dimensions L x W x H: 92 x 92 x 26 mm
- dimmable via optional illuminants

110421 silver coloured brushed

18,95 €

110427 black

18,95 €

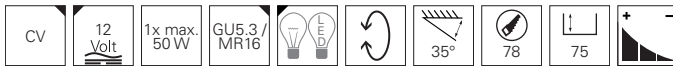

suitable illuminants on page 967-968



CEILING BUILT-IN RING

- aluminium
- dimensions L x W x H: 175 x 92 x 26 mm
- dimmable via optional illuminants

111821 silver coloured brushed

32,95 €

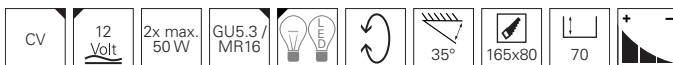

suitable illuminants on page 967-968



CEILING BUILT-IN RING

- gypsum
- dimensions Ø: 130 mm
- dimmable via optional illuminants

110501 white

23,95 €



suitable illuminants on page 967-968



CEILING BUILT-IN RING

- gypsum
- dimensions L x W x H: 120 x 120 x 55 mm
- dimmable via optional illuminants

110500 white

23,95 €



suitable illuminants on page 967-968



CEILING BUILT-IN RING

- gypsum
- dimensions H x Ø: 60 x 155 mm
- dimmable via optional illuminants

110503 white

39,95 €

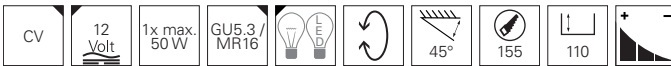

suitable illuminants on page 967-968



CEILING BUILT-IN RING

- metal
- dimensions H x Ø: 37 x 108 mm
- dimmable via optional illuminants

122408 silver coloured brushed

14,95 €



suitable illuminants on page 978

CEILING BUILT-IN RING

- stainless steel
- dimensions H x Ø: 35 x 85 mm
- dimmable via optional illuminants

122420 silver coloured brushed

16,95 €



suitable illuminants on page 967-968



CEILING BUILT-IN RING

- aluminium diecast
- dimensions Ø: 102 mm
- dimmable via optional illuminants

126070 Traffic white RAL 9016

15,95 €

126074 White aluminium RAL 9006 mat

15,95 €

126073 silver coloured brushed

15,95 €

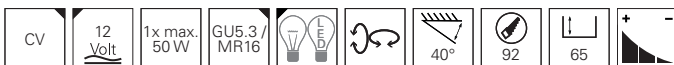

suitable illuminants on page 967-968

LIGHT POINT PERNO

The LIGHT POINT PERNO is a swivelling LED recessed ceiling luminaire that impresses with its compact and filigree form. The 360° swivelling, silver-coloured interior luminaire offers a tilt angle of 30° and is suitable for flexible illumination of displays, shop windows and exhibitions in the furniture sector. The LIGHT POINT PERNO has an aluminium housing and is available in warm white.



LIGHT POINT PERNO

- aluminium
- dimensions H x Ø: 15,7 x 39,6 mm

448001 silver coloured ww 3000 K 80 lm **55,95 €**





COB 95

- aluminium
- dimensions H x Ø: 46 x 108 mm
- dimmable via leading or trailing edge

565067	<input type="checkbox"/>	Signal white RAL 9003	ww	3000 K	820 lm	85,95 €
565070	<input type="checkbox"/>	silver coloured brushed	ww	3000 K	820 lm	85,95 €
565068	<input type="checkbox"/>	Signal white RAL 9003	nw	4000 K	860 lm	85,95 €
565071	<input type="checkbox"/>	silver coloured brushed	nw	4000 K	860 lm	85,95 €

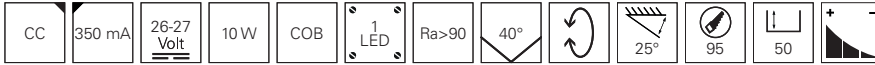

accessories

180512	power supply 350 mA 0,7-18,0 W	23,95 €
872643	power supply dimmable 350 mA 6,3-12,0 W	34,95 €





LED PANEL 8

- aluminium diecast
- dimensions H x Ø: 18 x 145 mm
- dimmable via optional power supply

565082	<input type="checkbox"/>	Signal white RAL 9003	<input type="checkbox"/>	2700 K	590 lm	34,95 €
565083	<input type="checkbox"/>	Pearl light grey RAL 9022	<input type="checkbox"/>	2700 K	590 lm	34,95 €
565084	<input type="checkbox"/>	Signal white RAL 9003	<input type="checkbox"/>	4000 K	610 lm	34,95 €
565085	<input type="checkbox"/>	Pearl light grey RAL 9022	<input type="checkbox"/>	4000 K	610 lm	34,95 €

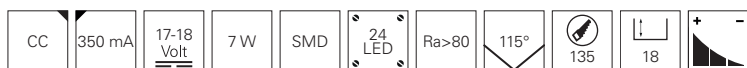

accessories

180512	power supply 350 mA 0,7-18,0 W	23,95 €
862202	power supply dimmable 350 mA 3,9-9,0 W	28,95 €
862190	power supply dimmable mit Dali1/Dali2, Intelli-Push 3,2-12,0 W	59,95 €



LED PANEL 12

- aluminium diecast
- dimensions H x Ø: 20 x 180 mm
- dimmable via optional power supply

565088	<input type="checkbox"/>	Signal white RAL 9003	<input type="checkbox"/>	2700 K	820 lm	49,95 €
565089	<input type="checkbox"/>	Pearl light grey RAL 9022	<input type="checkbox"/>	2700 K	820 lm	49,95 €
565090	<input type="checkbox"/>	Signal white RAL 9003	<input type="checkbox"/>	4000 K	870 lm	49,95 €
565091	<input type="checkbox"/>	Pearl light grey RAL 9022	<input type="checkbox"/>	4000 K	870 lm	49,95 €

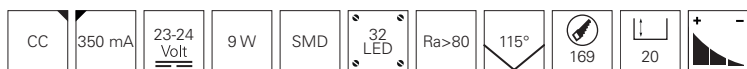

accessories

180512	power supply 350 mA 0,7-18,0 W	23,95 €
872643	power supply dimmable 350 mA 6,3-12,0 W	34,95 €
862190	power supply dimmable mit Dali1/Dali2, Intelli-Push 3,2-12,0 W	59,95 €



LED PANEL 16

- aluminium diecast
- dimensions H x Ø: 20 x 236 mm
- dimmable via optional power supply

565094	<input type="checkbox"/>	Signal white RAL 9003	ww	2700 K	1260 lm	69,95 €
565095	<input type="checkbox"/>	Pearl light grey RAL 9022	ww	2700 K	1260 lm	69,95 €
565096	<input type="checkbox"/>	Signal white RAL 9003	nw	4000 K	1150 lm	69,95 €
565097	<input type="checkbox"/>	Pearl light grey RAL 9022	nw	4000 K	1150 lm	69,95 €

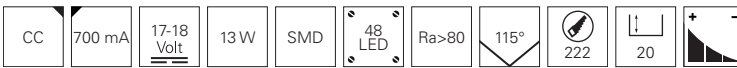

accessories

180514	power supply 700 mA 1,4-18,0 W	23,95 €
862207	power supply dimmable 700 mA 9,8-20,0 W	42,95 €
862190	power supply dimmable mit DALI1/DALI2, Intelli-Push 3,2-12,0 W	59,95 €





LED PANEL 8

- aluminium diecast
- dimensions H x Ø: 18 x 145 mm
- dimmable via optional controller

565102 Signal white RAL 9003 ww cw 2700-6000 K 470 lm **44,95 €**

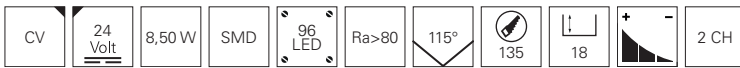

accessories

872633 power supply | 24V | 12,00 W **19,95 €**
862166 power supply | 24V | 100,00 W **94,95 €**
843057 RF controller set White | 12/24/48V **99,95 €**



LED PANEL 16

- aluminium diecast
- dimensions H x Ø: 20 x 236 mm
- dimmable via optional controller

565103 Signal white RAL 9003 ww cw 2700-6000 K 940 lm **74,95 €**

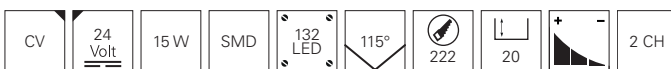

accessories

872636 power supply | 24V | 20,00 W **22,95 €**
862126 power supply | 24V | 150,00 W **129,95 €**
843057 RF controller set White | 12/24/48V **99,95 €**





COB 68 IP65

- aluminium diecast
- dimensions H x Ø: 44 x 78 mm
- 68er cutout
- dimmable via optional power supply

565108	<input type="checkbox"/>	Signal white RAL 9003		2700 K	670 lm	49,95 €
565109	<input type="checkbox"/>	Pearl light grey RAL 9022		2700 K	670 lm	49,95 €
565110	<input type="checkbox"/>	Signal white RAL 9003		4200 K	730 lm	49,95 €
565111	<input type="checkbox"/>	Pearl light grey RAL 9022		4200 K	730 lm	49,95 €



accessories

180512	power supply 350 mA 0,7-18,0 W	23,95 €
862202	power supply dimmable 350 mA 3,9 - 9 ,0 W	28,95 €



PUNTO LUMI

- aluminium
- dimensions H x Ø: 25 x 30 mm

565172	<input type="checkbox"/>	Traffic white RAL 9016		3000 K	40 lm	15,95 €
565173	<input type="checkbox"/>	silver coloured chrome		3000 K	40 lm	15,95 €

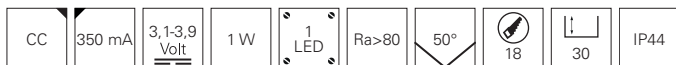

accessories

872628	power supply 350 mA 0,7 - 6,0 W	17,95 €
---------------	-------------------------------------	----------------



COB 68 CCT

- aluminium
- dimensions H x Ø: 46 x 78 mm
- dimmable via optional controller

565193	<input type="checkbox"/>	Signal white RAL 9003	ww cw	2500-6500 K	534 lm	55,95 €
565198	<input type="checkbox"/>	silver coloured brushed	ww cw	2500-6500 K	700 lm	55,95 €



accessories

872633	power supply 24V DC 12,0 W	19,95 €
862166	power supply 24V DC 100,0 W	94,95 €
843057	RF controller set White 21/24/48V	99,95 €



COB 95 CCT

- aluminium
- dimensions H x Ø: 65 x 108 mm
- dimmable via optional controller

565194	<input type="checkbox"/>	Signal white RAL 9003	ww cw	2500-6500 K	1118 lm	95,95 €
---------------	--------------------------	-----------------------	---------------------	-------------	---------	----------------



accessories

872636	power supply 24V DC 20,0 W	22,95 €
862168	power supply 24V DC 150,0 W	129,95 €
843057	RF controller set White 21/24/48V	99,95 €

COB 68 ACRYL

A spotlight with that certain something: thanks to its acrylic ring, the COB 68 ACRYL emits light not only downwards but also softly to the side. The resulting play of light on the ceiling makes for a discreet but effective eye-catcher and bathes every room in a cosy ambience.

COB 68 ACRYL

- acrylic glass
- dimensions H x Ø: 58,5 x 78 mm
- dimmable via optional controller

565247  colourless satined  2400-6500 K 590 lm



accessories

- 930270** acrylic ring round | 90 mm
930271 acrylic ring angular | 90 x 90 mm
872633 power supply | 24V DC | 12,0 W
862166 power supply | 24V DC | 100,0 W
843057 RF controller set White | 21/24/48V



55,95 €



19,95 €

19,95 €





19,95 €

94,95 €

99,95 €

COB 68 ACRYL

- aluminium
- dimensions L x H x Ø: 78 x 53,5 x 78 mm
- dimmable via optional power supply

565195  colourless satined  2700 K 675 lm
565196  colourless satined  4000 K 730 lm



accessories

- 930270** acrylic ring round | 90 mm
930271 acrylic ring angular | 90 x 90 mm
180512 power supply | 350 mA | 0,7-18,0 W
862202 power supply dimmable | 350 mA | 3,9 - 9 ,0 W



55,95 €

55,95 €



19,95 €



19,95 €

23,95 €

28,95 €

COB 68 ACRYL

- aluminium
- dimensions L x H x Ø: 78 x 53,5 x 78 mm
- dimmable via optional controller

565197  colourless satined  230 lm



55,95 €

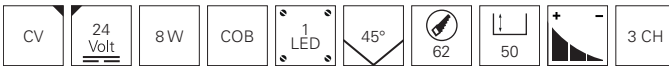

accessories

- 930270** acrylic ring round | 90 mm
930271 acrylic ring angular | 90 x 90 mm
872633 power supply | 24V DC | 12,0 W
862166 power supply | 24V DC | 100,0 W
843058 RF controller set Color | 21/24/48V

19,95 €

19,95 €

19,95 €

94,95 €

104,95 €





SATURN

- aluminium
- dimensions H x Ø: 49 x 100 mm
- dimmable via optional power supply

565200	<input type="checkbox"/>	white chrome		2700 K	700 lm	65,95 €
565201	<input checked="" type="checkbox"/>	black chrome		2700 K	700 lm	65,95 €
565202	<input type="checkbox"/>	white chrome		4000 K	720 lm	65,95 €
565203	<input checked="" type="checkbox"/>	black chrome		4000 K	720 lm	65,95 €

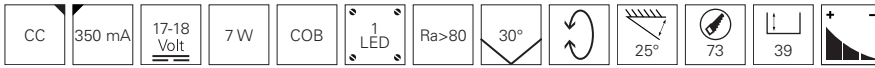

accessories

180512	power supply 350 mA 0,7 - 18,0 W	23,95 €
872642	power supply dimmable 350 mA 9,0 W	24,95 €
862202	power supply dimmable 350 mA 3,9 - 9 ,0 W	28,95 €





ORIONIS

- aluminium diecast
- dimensions H x Ø: 72 x 78 mm
- dimmable via optional power supply

565237	<input type="checkbox"/>	white mat inner ring white mat	2700 K	645 lm	75,95 €
565240	<input type="checkbox"/>	black mat inner ring black mat	2700 K	645 lm	75,95 €

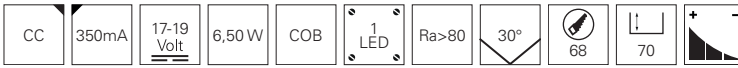

accessories

180512	power supply 350 mA 0,7 - 18,0 W	23,95 €
872642	power supply dimmable 350 mA 9 W	24,95 €
862202	power supply dimmable 350 mA 3,9 - 9 ,0 W	28,95 €



ORIONIS

- aluminium diecast
- dimensions L x W x H: 78 x 78 x 72 mm
- dimmable via optional power supply

565241	<input type="checkbox"/>	white mat inner ring white mat	2700 K	645 lm	79,95 €
565244	<input type="checkbox"/>	black mat inner ring black mat	2700 K	645 lm	79,95 €

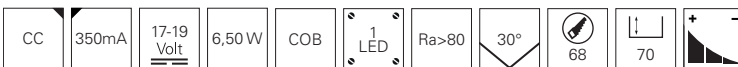

accessories

180512	power supply 350 mA 0,7 - 18,0 W	23,95 €
872642	power supply dimmable 350 mA 9 W	24,95 €
862202	power supply dimmable 350 mA 3,9 - 9 ,0 W	28,95 €



COB 94 RGBW

- aluminium diecast
- dimensions H x Ø: 70 x 110 mm
- dimmable via optional controller

565245	<input type="checkbox"/>	Grey white RAL 9002 mat		3000 K	710 lm	119,95 €
565246	<input type="checkbox"/>	silver coloured brushed		3000 K	710 lm	119,95 €

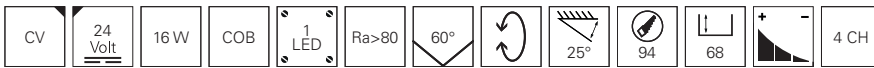

accessories

872636	power supply 24V 20,0 W	22,95 €
862166	power supply 24V 100,0 W	94,95 €
843059	RF controller set RGB+White 21/24/48V	109,95 €





LED PANEL 8

- aluminium diecast
- dimensions H x Ø: 18 x 145 mm
- dimmable via optional controller

565248 Signal white RAL 9003  3000 K 140 lm **44,95 €**

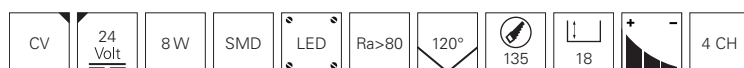

accessories

872633 power supply | 24V | 12,0 W **19,95 €**

862166 power supply | 24V | 100,0 W **94,95 €**

843059 RF controller set RGB+White | 21/24/48V **109,95 €**



LED PANEL 16

- aluminium diecast
- dimensions H x Ø: 20 x 236 mm
- dimmable via optional controller

565249 Signal white RAL 9003  3000 K 380 lm **74,95 €**

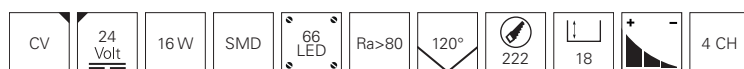

accessories

872636 power supply | 24V | 20,0 W **22,95 €**





862166 power supply | 24V | 100,0 W **94,95 €**

843059 RF controller set RGB+White | 21/24/48V **109,95 €**



COB-68-350MA-2700K-ROUND-FLAT

- aluminium
- dimensions H x Ø: 30 x 78 mm
- dimmable via optional power supply

565263	<input type="checkbox"/>	Signal white RAL 9003		2700 K	490 lm	45,95 €
565262	<input type="checkbox"/>	silver coloured brushed		2700 K	490 lm	45,95 €
565265	<input type="checkbox"/>	Signal white RAL 9003		4000 K	540 lm	45,95 €
565264	<input type="checkbox"/>	silver coloured brushed		4000 K	540 lm	45,95 €

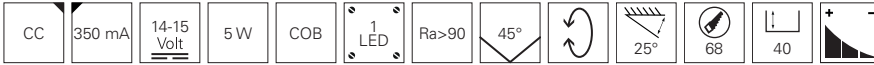

accessories

872646	power supply 350 mA 8 W	19,95 €
862202	power supply dimmable 350 mA 3,9-9,0 W	28,95 €



With the kind support of Göbel's Schlosshotel / 36289 Friedewald



COB-68-350MA-2700K-ROUND

- aluminium
- dimensions H x Ø: 46 x 78 mm
- dimmable via optional power supply

565279	<input type="checkbox"/>	Signal white RAL 9003	ww	2700 K	580 lm	53,95 €
565278	<input type="checkbox"/>	silver coloured brushed	ww	2700 K	580 lm	49,95 €
565281	<input type="checkbox"/>	Signal white RAL 9003	nw	4000 K	660 lm	53,95 €
565280	<input type="checkbox"/>	silver coloured brushed	nw	4000 K	660 lm	53,95 €

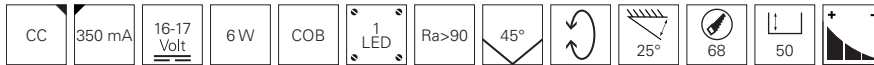

accessories

180512	power supply 350 mA 0,7-18,0 W	23,95 €
862202	power supply dimmable 350 mA 3,9-9,0 W	28,95 €



COB-68-350MA-2700K-ANGULAR

- aluminium
- dimensions L x W x H: 78 x 78 x 46 mm
- dimmable via optional power supply

565283	<input type="checkbox"/>	Signal white RAL 9003	ww	2700 K	580 lm	55,95 €
565282	<input type="checkbox"/>	silver coloured brushed	ww	2700 K	580 lm	55,95 €
565285	<input type="checkbox"/>	Signal white RAL 9003	nw	4000 K	660 lm	55,95 €
565284	<input type="checkbox"/>	silver coloured brushed	nw	4000 K	660 lm	55,95 €

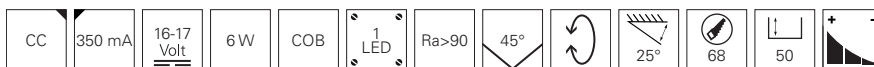

accessories

180512	power supply 350 mA 0,7-18,0 W	23,95 €
862202	power supply dimmable 350 mA 3,9-9,0 W	28,95 €



COB-68-24V-2700K-ROUND

- aluminium diecast
- dimensions H x Ø: 36,00 x 85,00 mm
- dimmable via optional power supply

565300	<input type="checkbox"/>	Signal white RAL 9003	ww	2700 K	330 lm	53,95 €
565299	<input type="checkbox"/>	silver coloured brushed	ww	2700 K	330 lm	53,95 €
565302	<input type="checkbox"/>	Signal white RAL 9003	nw	4000 K	370 lm	53,95 €
565301	<input type="checkbox"/>	silver coloured brushed	nw	4000 K	370 lm	53,95 €

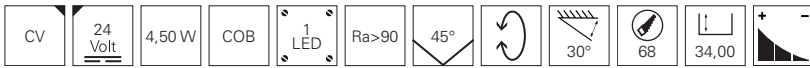

accessories

872630	power supply 24V DC 6,0 W	16,95 €
872636	power supply 24V 20,0 W	22,95 €
862122	power supply 24V DC 50,0 W	54,95 €
843056	RF controller set Single 12/24/48V	94,95 €



COB-68-24V-2700K-ROUND

- aluminium diecast
- dimensions H x Ø: 51,50 x 85,00 mm
- dimmable via optional power supply

565304	<input type="checkbox"/>	Signal white RAL 9003	ww	2700 K	630 lm	55,95 €
565303	<input type="checkbox"/>	silver coloured brushed	ww	2700 K	630 lm	55,95 €
565306	<input type="checkbox"/>	Signal white RAL 9003	nw	4000 K	720 lm	55,95 €
565305	<input type="checkbox"/>	silver coloured brushed	nw	4000 K	720 lm	55,95 €

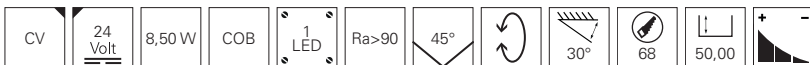

accessories

872633	power supply 24V 12,0 W	19,95 €
872636	power supply 24V 20,0 W	22,95 €
862166	power supply 24V 100,0 W	94,95 €
843056	RF controller set Single 12/24/48V	94,95 €



COB-95-24V-2700K-ROUND

- aluminium diecast
- dimensions H x Ø: 55,00 x 115,00 mm
- dimmable via optional power supply

565308	<input type="checkbox"/>	Signal white RAL 9003		2700 K	900 lm	95,95 €
565307	<input type="checkbox"/>	silver coloured brushed		2700 K	900 lm	95,95 €
565310	<input type="checkbox"/>	Signal white RAL 9003		4000 K	1000 lm	95,95 €
565309	<input type="checkbox"/>	silver coloured brushed		4000 K	1000 lm	95,95 €



accessories

872636	power supply 24V 20,0 W	22,95 €
862122	power supply 24V DC 50,0 W	54,95 €
862166	power supply 24V 100,0 W	94,95 €
843056	RF controller set Single 12/24/48V	94,95 €



COB 68 RGBW

- aluminium
- dimensions H x Ø: 46 x 78 mm
- 68er cutout
- dimmable via optional controller

565335	<input type="checkbox"/>	Signal white RAL 9003		500 lm	99,95 €
565336	<input type="checkbox"/>	silver coloured brushed		500 lm	99,95 €



accessories

872633	power supply 24V 12,0 W	19,95 €
862122	power supply 24V DC 50,0 W	54,95 €
843059	RF controller set RGB+White 21/24/48V	109,95 €

SMD-68-230V-2700K-RUND

A lot of power for a small price! The recessed luminaires of the SMD-68 series provide up to 550 lm and also have an integrated, dimmable power supply unit [230V direct connection], which makes the use of GU10 sockets and retrofit upgrades unnecessary.



SMD-68-230V-2700K-ROUND

- plastic
- dimensions H x Ø: 44 x 85 mm
- dimmable via leading or trailing edge

565337	<input type="checkbox"/>	Traffic white RAL 9016	2700 K	510 lm	20,95 €
565338	<input type="checkbox"/>	Traffic white RAL 9016	3000 K	540 lm	20,95 €
565339	<input type="checkbox"/>	Traffic white RAL 9016	4000 K	550 lm	20,95 €





COB 68 MOOD IP65

- aluminium
- dimensions H x Ø: 66 x 83 mm
- dim to warm

565192 Signal white RAL 9003 ■ 2000-2800 K 500 lm **65,95 €**



accessories

930079	cover angular metal silver satined 83 x 83 x 4 mm	9,95 €
930075	cover angular metal white mat 83 x 83 x 4 mm	9,95 €
930077	cover angular metal chrome look 83 x 83 x 4 mm	9,95 €
930100	cover angular metal silver brushed 83 x 83 x 4 mm	9,95 €
930078	cover round metal silver satined 83 x 4 mm	9,95 €
930074	cover round metal white mat 83 x 4 mm	9,95 €
930076	cover round metal chrome look 83 x 4 mm	9,95 €
930099	cover round metal silver brushed 83 x 4 mm	9,95 €

COB BACK LIGHT

Designed as a recessed ceiling luminaire for indoor use, the COB BACK LIGHT is equally suitable for classic and modern interiors and architectural projects. The 9 Watt COB warm white LED with 48° beam angle sits in a white die-cast aluminium housing and creates additional, indirect light via the integrated reflector for even more atmosphere in the room.



COB BACK LIGHT

- aluminium diecast
- dimensions H x Ø: 89 x 110 mm
- dimmable via optional power supply

565224 white  3000K 1000 lm **95,95 €**

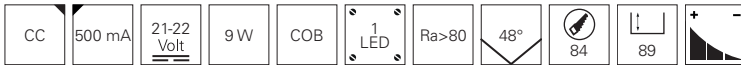

accessories

180513 power supply | 500 mA | 1,0-18,0 W **23,95 €**

862030 power supply dimmable | 500 mA | 6,0-12,0 W **29,95 €**



LESATH

In various shapes and surface finishes, the LESATH swivel-mounted recessed ceiling luminaire can be used in a wide variety of applications - from retail and gastronomy to private living spaces. Additional flexibility for planners, architects and electricians is provided by the warm white light source that can vary its colour temperature [2000 – 2800 K] by dimming via phase control. The integrated power supply unit for the 7 Watt LED ensures easy installation.



LESATH

- aluminium diecast
- dimensions H x Ø: 60 x 85 mm
- dim to warm

565261 ■ black ww 2000-2800 K 500 lm **88,95 €**



accessories

930252	frame round aluminium brushed 22 x 90 mm	7,95 €
930254	frame round aluminium chrome look 22 x 90 mm	7,95 €
930253	frame round aluminium white painted 22 x 90 mm	7,95 €
930255	frame angular aluminium brushed 90 x 90 x 22 mm	8,95 €
930257	frame angular aluminium chrome look 90 x 90 x 22 mm	8,95 €
930256	frame angular aluminium white painted 90 x 90 x 22 mm	8,95 €



□ ■
page 162



□ ■
page 164



□ □ ■
page 166



□ □
page 166



□ □ ■
page 168



□ □
page 170



□ □
page 172



□ □
page 174



□ □ □
page 175



□ □ □
page 176



□ □ □
page 178



□ □ □
page 178



□
page 180



□ □ □
page 182



□
page 184



□
page 184



□
page 185



□
page 185



□
page 186



□
page 186



□
page 187



□
page 187

surface mounted wall lights



□
page 188



□
page 188



□
page 189



□
page 189



□
page 190



□
page 190



□
page 191



□
page 191



□
page 192



□
page 193



■
page 194

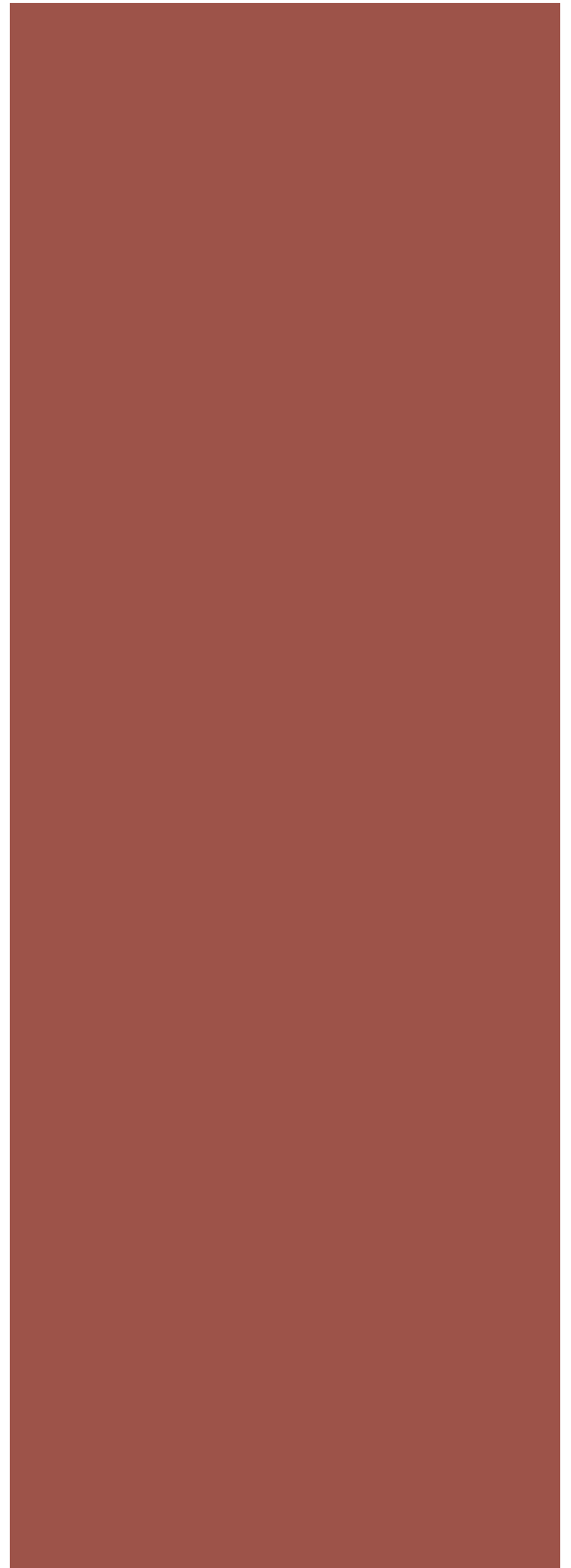

BERMUDA II

Clear design language, visual highlight! With the BERMUDA luminaire series developed by our designer Johannes Tomm, you can create a feel-good atmosphere far away from the typical »0815«.

Whether elegant wall lamp, unusual table and floor lamp or even the lighting of your garden – the BERMUDA series gives every lighting situation its own special touch.



suitable
table /
floor lights
page 212
346018
346017
343029
343028



suitable
wall light
IP65
page 356
731124



suitable
bollard light
IP65
page 294
731124

BERMUDA II

• Design by Johannes Tomm

• easy mounting

• 360° beam angle

• aluminium diecast

• dimensions L x H: 123 x 200 mm

• socket H x Ø: 93 x 70 mm

342159 white

3000 K

655 lm **125,95 €**

342160 Black grey RAL 7021

3000 K

655 lm **125,95 €**



suitable
ground spike
lights
IP65
page 392
733060
733059



ASTEROPE LINEAR

Light & shadow: Hardly any luminaire embodies this dualism more beautifully than the ASTEROPE in its various versions. The wall luminaire, which is open at the top and bottom, creates a multifaceted play of light and shadow on walls and ceilings that blends extravagantly yet harmoniously into any ambience.



suitable
pendant lights
page 47
342135
342136



suitable
table /
floor lights
page 216
346003
346004
343020
343021

ASTEROPE LINEAR

- metal
- dimensions L x W: 300 x 150 mm
- dimmable via optional illuminants

- 341216** white mat **65,95 €**
- 341217** black mat **65,95 €**



suitable illuminants on page 972



ARIETIS

A modern wall lamp with outstanding design and glare-free light. The ARIETIS impresses with its clear line, the beautiful and very elegant finish in polished aluminium and convinces completely with the built-in G9 socket. This gives you the possibility to choose the right illuminant for you. Whether halogen or LED, warm white or cool white, you have the strings in your hand. Hardly any other luminaire emphasises your modern lifestyle like the ARIETIS.

ARIETIS

- aluminium diecast
- dimensions L x W x H: 170 x 85 x 70 mm
- socket L x W x H: 120 x 45 x 20 mm
- dimmable via optional illuminants

341188	<input type="checkbox"/>	Signal white RAL 9003	69,95 €
341189	<input type="checkbox"/>	silver coloured	69,95 €
341190	<input type="checkbox"/>	Traffic black RAL 9017	69,95 €



suitable illuminants on page 978



BOOTIS

- aluminium diecast
- dimensions L x W x H: 300 x 79 x 66 mm
- socket L x W x H: 165 x 45 x 20 mm
- dimmable via optional illuminants

341191	<input type="checkbox"/>	Signal white RAL 9003	99,95 €
341192	<input type="checkbox"/>	silver coloured	99,95 €



suitable illuminants on page 979





ACAMAR

Small, noble, elegant and unobtrusive – the ACAMAR is a luminaire made of high-quality aluminium. The colour rendering value is over 90, which means high colour fastness. The design is chic and interesting due to the single-sided rounding. You can mount the luminaire with the rounding upwards or downwards, depending on your preference. The white lacquering on the inside emphasises the warm white light and distributes it pleasantly upwards and downwards. The outside is highly polished and thus shines in full brilliance.



ACAMAR

- aluminium diecast
- dimensions L x W x H: 170 x 100 x 80 mm
- socket L x W x H: 120 x 60 x 33 mm
- dimmable via leading or trailing edge

341194	<input type="checkbox"/>	Signal white RAL 9003	<input type="checkbox"/>	3000 K	390 lm	109,95 €
341195	<input type="checkbox"/>	silver coloured	<input type="checkbox"/>	3000 K	400 lm	109,95 €
341196	<input type="checkbox"/>	Traffic black RAL 9017	<input type="checkbox"/>	3000 K	250 lm	109,95 €



With the kind support of Regionaldirektion für Deutsche Vermögensberatung Pierre Werner / Direktion für Deutsche Vermögensberatung Uwe Liebholz



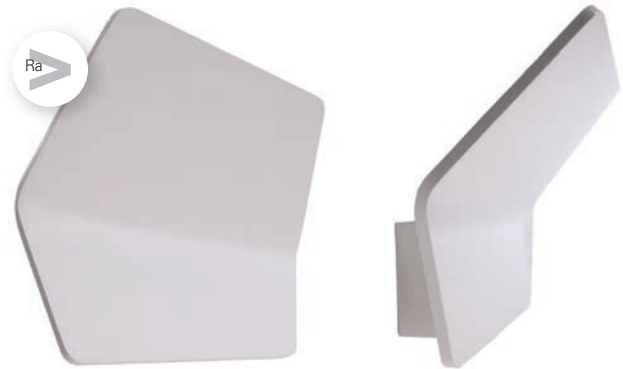

KEOPS

Thanks to its simple design, the KEOPS LED wall-mounted luminaire blends seamlessly into a wide variety of room interiors and provides flexibly applicable, indirect lighting accents. This is ensured by the innovative dimming function of the interior luminaire, on the basis of which the colour temperature can be continuously adjusted in the range from 3000 K [100%] to 2000 K [0%]. In this way, KEOPS creates a different, indirect lighting mood as required – from room light to dignified ambient light.



KEOPS

- aluminium diecast
- dimensions L x W x H: 170 x 155 x 115 mm
- socket L x W x H: 120 x 58 x 33 mm
- dimmable via leading or trailing edge
- dim to warm

341161	<input type="checkbox"/>	Signal white RAL 9003	 2000-3000 K	950 lm	199,95 €
341160	<input type="checkbox"/>	White aluminium RAL 9006	 2000-3000 K	950 lm	199,95 €





CANOPUS

Our light chameleon: extraordinary design meets innovative dimmer technology. The further you dim the CANOPUS, the warmer the light becomes. No luminaire comes close to real candlelight - but the CANOPUS is not far off. Elegant, glare-free and modern ambient lighting at its best!

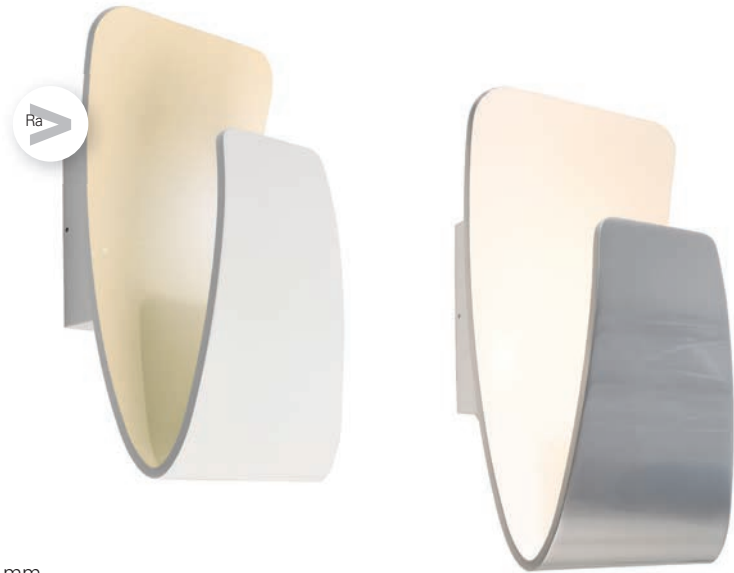

CANOPUS

- aluminium diecast
- dimensions L x W x H: 140 x 115 x 265 mm
- socket L x W x H: 110 x 110 x 33 mm
- dim to warm

341197	<input type="checkbox"/>	Signal white RAL 9003	<input checked="" type="checkbox"/>	2000-3000 K	900 lm	199,95 €
341198	<input type="checkbox"/>	silver coloured	<input checked="" type="checkbox"/>	2000-3000 K	900 lm	199,95 €







PARALA & LARGA

The simple PARALA and LARGA wall-mounted luminaires impress with their linear design and high-quality aluminium housing, which is available in two different finishes. However, they not only set the stage with their modern housing shape, but also create a pleasant lighting atmosphere with their indirect warm white light source.



PARALA 425

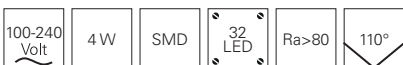

- aluminium diecast
- dimensions L x W x H: 425 x 44 x 34 mm
- socket L x W x H: 170 x 44 x 34 mm

341208	<input type="checkbox"/>	white satined	ww	3000 K	440 lm	96,95 €
341207	<input type="checkbox"/>	silver coloured brushed	ww	3000 K	440 lm	96,95 €



LARGA 910

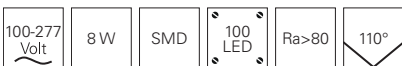

- aluminium diecast
- dimensions L x W x H: 910 x 44 x 44 mm
- socket L x W x H: 170 x 44 x 37 mm

341210	<input type="checkbox"/>	white satined	 3000 K	770 lm	199,95 €
341209	<input type="checkbox"/>	silver coloured brushed	 3000 K	770 lm	199,95 €



LARGA 1700

- aluminium diecast
- dimensions L x W x H: 1700 x 44 x 44 mm
- socket L x W x H: 170 x 44 x 37 mm

341212	<input type="checkbox"/>	white satined	 3000 K	1470 lm	285,95 €
341211	<input type="checkbox"/>	silver coloured brushed	 3000 K	1470 lm	285,95 €

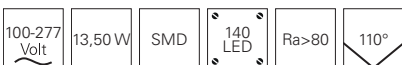





APODIS

Luminaire or piece of jewellery? We are happy to leave the decision to you. However, the APODIS in its two lengths and surface finishes in gold and rose gold is a timeless and flexible lighting element that decorates every wall with its dimmable, two-sided LED light emission.



APODIS 500





- aluminium
- dimensions L x W x H: 76 x 61 x 500 mm
- socket L x W x H: 60 x 18 x 100 mm
- dimmable via leading or trailing edge

341200		gold optics		3000 K	350 lm	159,95 €
341201		rose		3000 K	350 lm	159,95 €



APODIS 800

- aluminium
- dimensions L x W x H: 76 x 61 x 800 mm
- socket L x W x H: 60 x 18 x 100 mm
- dimmable via leading or trailing edge

341202		gold optics		3000 K	450 lm	199,95 €
341203		rose		3000 K	450 lm	199,95 €









CUBE

- concrete
- dimensions L x W x H: 115 x 115 x 115 mm
- dimmable via optional illuminants

341183	 grey	75,95 €
341184	 dark grey	75,95 €
341185	 beige	75,95 €













suitable illuminants on page 978



MINI CUBE

- aluminium
- dimensions L x W x H x Ø: 80 x 80 x 65 x 100 mm
- socket Ø: 100 mm

620137	 gypsum white	 3000 K	350 lm	79,95 €
620136	 concrete grey	 3000 K	350 lm	79,95 €
620139	 concrete grey granite	 3000 K	350 lm	79,95 €
620138	 concrete beige granite	 3000 K	350 lm	79,95 €
620140	 concrete black	 3000 K	350 lm	79,95 €

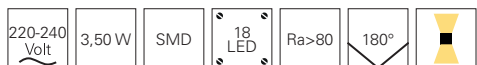



QUINTA II

Concrete – Cube – LED module what more could you want? The timeless shape of the cube was made of concrete and equipped with an efficient 6 Watt LED module. This combination makes QUINTA II the ideal luminaire for many interior applications. Whether as room light or accent lighting, with QUINTA II you are definitely on the fast track in terms of design.



QUINTA II

- concrete
- dimensions L x W x H: 125 x 60 x 125 mm
- socket L x W x H: 100 x 80 x 45 mm

341180  grey  3000 K 250 lm **119,95 €**

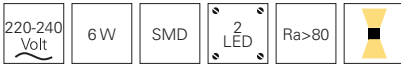



YPSILON

Geometric design and maximum variability – the YPSILON consists of two parts, a base and the name-giving interchangeable Y-part. Thanks to the round base and the variable mounting, one or more YPSILON luminaires can be used to create highly interesting light effects on walls. Just a few degrees of rotation creates a completely different light image. Thanks to the many different materials, e.g. white plaster, which can also be customised, or grey granite, almost impossible variations can be conjured up.



YPSILON

- aluminium | gypsum | concrete
- dimensions L x W x H x Ø: 245 x 232 x 65 x 100 mm
- socket Ø: 100 mm

620132	■ gypsum white paintable	ww	3000 K	350 lm	99,95 €
620135	■ concrete grey granite	ww	3000 K	350 lm	99,95 €
620134	■ concrete beige granite	ww	3000 K	350 lm	99,95 €
620133	■ concrete black	ww	3000 K	350 lm	99,95 €

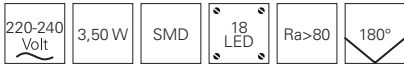





ARIANNA II

- concrete
- dimensions L x W x H: 200 x 85 x 120 mm
- socket L x W x H: 135 x 3 x 65 mm
- dimmable via optional illuminants

341187 ■ grey

64,95 €



suitable illuminants on page 978



SARIN

- concrete
- dimensions L x W x H: 300 x 100 x 75 mm
- socket L x W x H: 158 x 38 x 53 mm
- dimmable via optional illuminants

341178 ■ grey

64,95 €



suitable illuminants on page 972



ATRIA

- concrete
- dimensions L x W x H: 180 x 100 x 90 mm
- socket L x W x H: 65 x 71 x 19 mm
- dimmable via optional illuminants

341176  grey

79,95 €



suitable illuminants on page 978



OSANO II

- concrete
- dimensions L x W x H: 150 x 130 x 128 mm
- socket L x W x H: 58 x 63 x 23 mm
- dimmable via optional illuminants

341177  grey

64,95 €

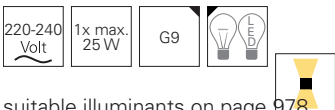

suitable illuminants on page 978

FLY

FLY is a wall-mounted luminaire based on a patented design by Johannes Tomm, available exclusively from DEKO-LIGHT. With its unusual plaster construction, the FLY can be individually designed and creates an indirect, glare-free light that blends into different spaces without any problems.



FLY I + II

- gypsum
- dimensions L x W x H: 240 x 123 x 170 mm
- socket H x Ø: 60 x 100 mm
- dimmable via leading or trailing edge

341222	<input type="checkbox"/>	white paintable	 3000 K	310 lm	99,95 €
341224	<input type="checkbox"/>	white paintable	 3000 K	310 lm	99,95 €

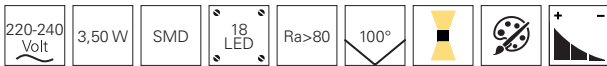



DL TWYNNDA I + II

- gypsum
- dimensions L x W x H: 321 x 120 x 130 mm
- socket L x W: 198 x 20 mm
- dimmable via optional illuminants

341205 white paintable **51,95 €**

341206 white paintable **51,95 €**

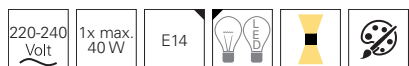

suitable illuminants on page 972

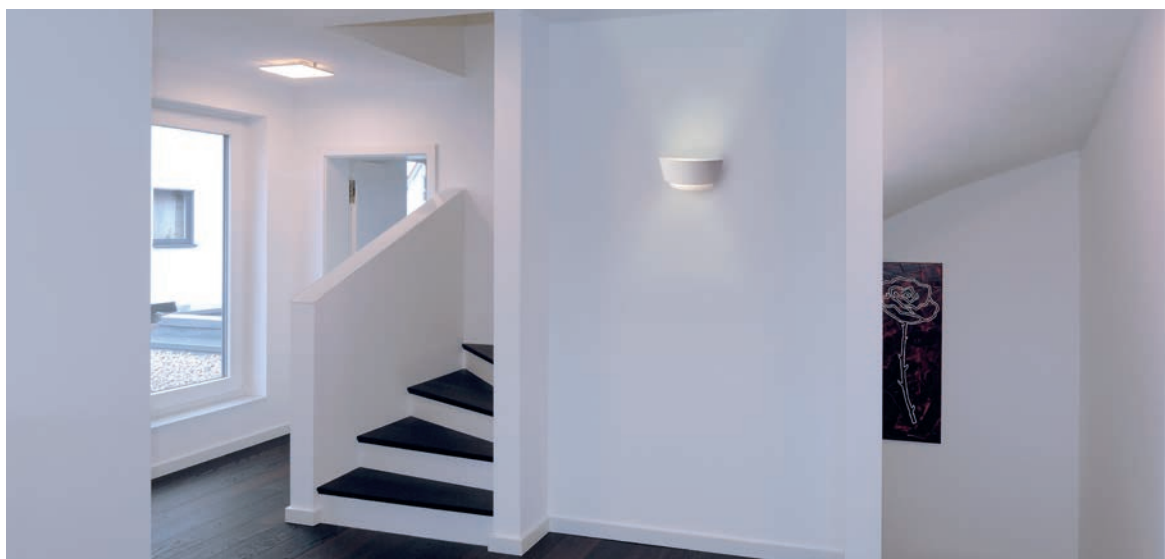

GIORGIA

- gypsum
- dimensions L x W x H: 70 x 100 x 120 mm
- socket L x W: 90 x 45 mm
- dimmable via optional illuminants

341033 white paintable

45,95 €



suitable illuminants on page 978

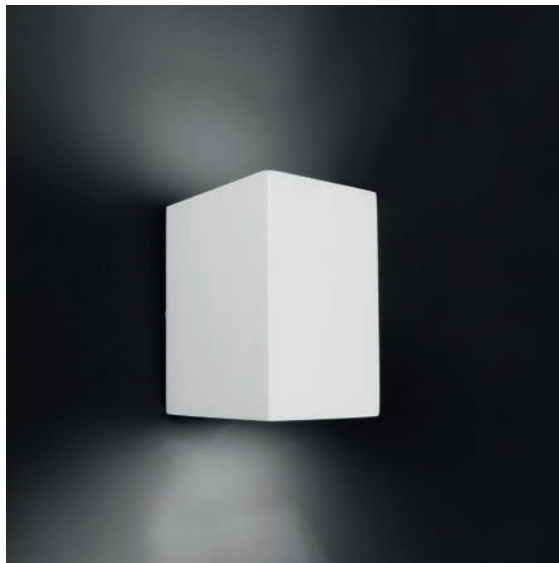

OLGA

- gypsum
- dimensions L x W x H: 142 x 142 x 140 mm
- socket L x W x H: 120 x 120 x 17 mm
- dimmable via optional illuminants

341225 white paintable

47,95 €



suitable illuminants on page 978



RELONO

- gypsum
- dimensions L x W x H: 260 x 90 x 300 mm
- socket L x W: 180 x 180 mm
- dimmable via optional illuminants

341010 white paintable

53,95 €



suitable illuminants on page 972

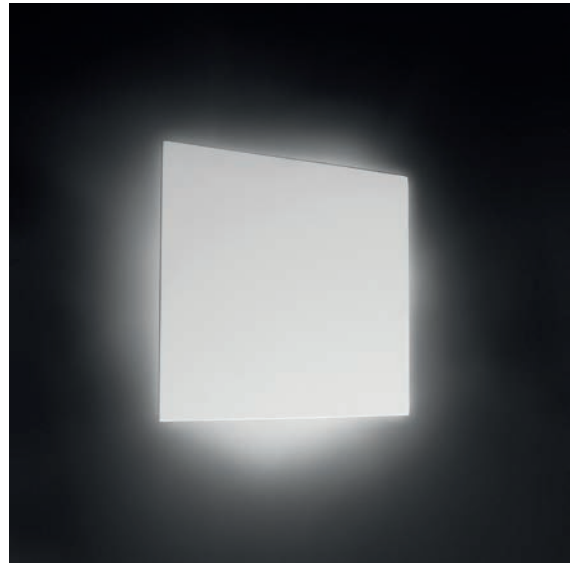

ESSA

- gypsum
- dimensions L x W x H: 255 x 75 x 100 mm
- socket L x W: 88 x 58 mm
- dimmable via optional illuminants

341105 white paintable

59,95 €



suitable illuminants on page 969-970





QUINTA

- gypsum
- dimensions L x W x H: 125 x 60 x 125 mm
- socket L x W: 100 x 60 mm

341062 white paintable  3000 K 270 lm **95,95 €**

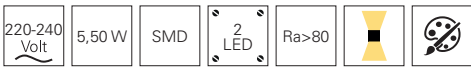

ARIANNA

- gypsum
- dimensions L x W x H: 300 x 95 x 140 mm
- socket L x W: 155 x 20 mm
- dimmable via optional illuminants

341035 white paintable **63,95 €**



suitable illuminants on page 979

NETITO

- gypsum
- dimensions L x W x H: 245 x 123 x 92 mm
- socket L x W: 180 x 14 mm
- dimmable via optional illuminants

341057 white paintable

63,95 €



suitable illuminants on page 979



CAROLINE

- gypsum
- dimensions L x W x H: 377 x 177 x 121 mm
- socket L x W x H: 215 x 62 x 20 mm
- dimmable via optional illuminants

341223 white paintable

95,95 €



suitable illuminants on page 974-977



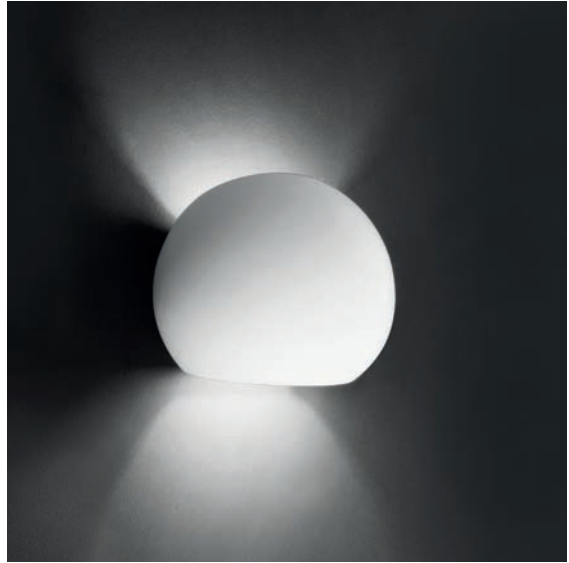

OSANO

- gypsum
- dimensions L x W x H: 150 x 115 x 125 mm
- socket L x W: 62 x 57 mm
- dimmable via optional illuminants

341065 white paintable

48,95 €



suitable illuminants on page 978

CREATIVE IDEAS FOR YOUR PLASTER LUMINAIRES

Plaster luminaires are very easy to design individually. After priming [e.g. with deep primer], you can paint, spray, varnish or even glue on the plaster surface. Experienced designers carefully remove or apply material and thus create a real one-of-a-kind luminaire – as in the three examples below, which were individually designed and have since caused a stir not only in the living room, hallway and staircase area, but also in the children's room...



ILARIA

- gypsum
- dimensions L x W x H: 245 x 115 x 230 mm
- socket L x W: 145 x 100 mm
- dimmable via optional illuminants

341056 white paintable

52,95 €



suitable illuminants on page 978



MADERA

The MADERA series is made of first-class European oak wood and impresses with its modern design and mix of materials in private living areas, hotels, restaurants and many more. The noble MADERA luminaires distribute their powerful warm white light in any room and thus also cut an excellent figure as functional and high-quality lighting at reception counters and more.



suitable
ceiling light
page 113
348147



suitable
pendant light
page 86
342169



suitable
table /
floor lights
page 220
346044
343031

MADERA

- modern, exclusive design
- manufactured in Europe from high-quality oak wood of grade A
- FSC-certified raw material oak wood
- environmentally friendly packaging
- infinitely dimmable via discreet, side-mounted touch sensor
- oak wood | aluminium
- dimensions L x W x H: 450 x 60 x 130 mm
- socket L x W x H: 250 x 60 x 30 mm

341248 ■ wood, black ■ 3000 K 560 lm **235,95 €**







□
page 198



□ □ ■
page 198



□ □ ■
page 198



□ □ ■
page 198



□ □
page 198



□
page 199



□ □ ■
page 199



□ □ ■
page 199



□ □ ■
page 199



□ □ ■
page 199



□ □ ■
page 201



□ □ ■
page 201



□ □ ■
page 201



□ □ ■
page 201

built in wall lights



ALWAID

ALWAID is your problem solver when space is tight. Thanks to its small design, the recessed wall luminaire fits into all 68 mm deep switch boxes and does not require a power supply unit.

With its numerous covers, it blends safely into its surroundings and presents a beautiful indirect light that can be dimmed.

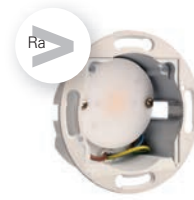

ALWAID

- aluminium diecast
- dimensions H x Ø: 40 x 71 mm
- dimmable via leading or trailing edge
- suitable for 68 mm switch boxes in deep version

563008 Traffic white RAL 9016 ww 2700 K 230 lm **74,95 €**

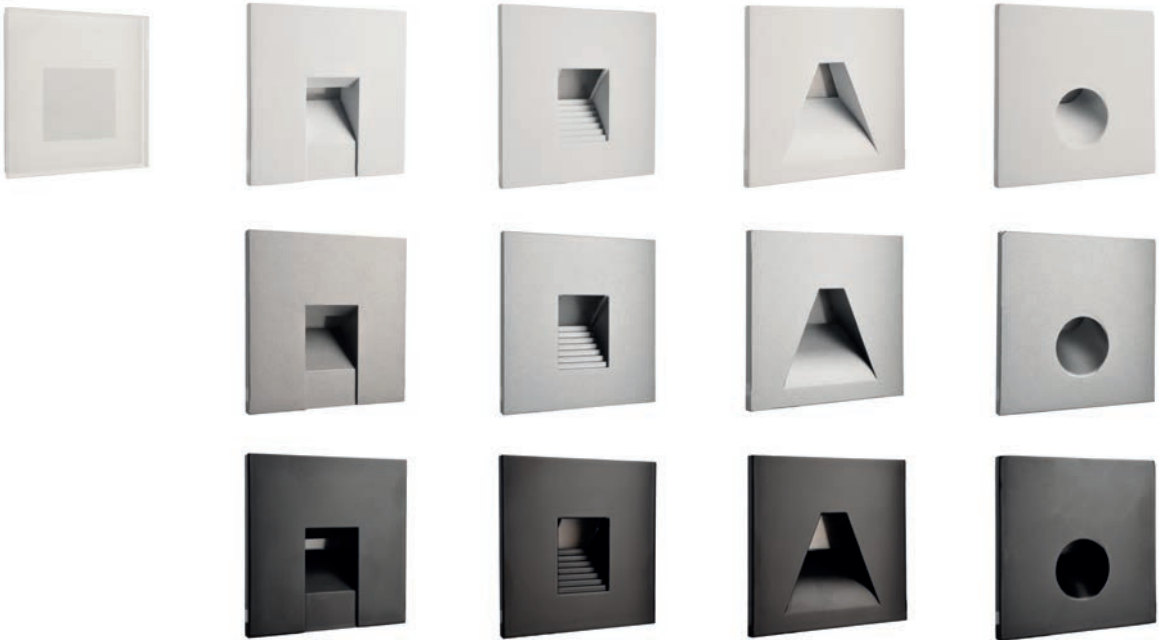
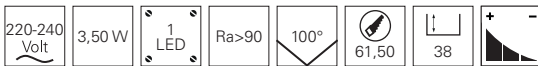

covers

930480	<input type="checkbox"/> angular milky Traffic white RAL 9016 L x W x H: 78 x 78 x 22 mm	19,95 €
930482	<input type="checkbox"/> angular square Traffic white RAL 9016 L x W x H: 75 x 75 x 22 mm	15,95 €
930485	<input type="checkbox"/> angular step Traffic white RAL 9016 L x W x H: 75 x 75 x 22 mm	15,95 €
930488	<input type="checkbox"/> angular trapeze Traffic white RAL 9016 L x W x H: 75 x 75 x 22 mm	15,95 €
930491	<input type="checkbox"/> angular round Traffic white RAL 9016 L x W x H: 75 x 75 x 22 mm	15,95 €
930483	<input type="checkbox"/> angular square White aluminium RAL 9006 L x W x H: 75 x 75 x 22 mm	15,95 €
930486	<input type="checkbox"/> angular step White aluminium RAL 9006 L x W x H: 75 x 75 x 22 mm	15,95 €
930489	<input type="checkbox"/> angular trapeze White aluminium RAL 9006 L x W x H: 75 x 75 x 22 mm	15,95 €
930492	<input type="checkbox"/> angular round White aluminium RAL 9006 L x W x H: 75 x 75 x 22 mm	15,95 €
930484	<input checked="" type="checkbox"/> angular square Jet black RAL 9005 L x W x H: 75 x 75 x 22 mm	15,95 €
930487	<input checked="" type="checkbox"/> angular step Jet black RAL 9005 L x W x H: 75 x 75 x 22 mm	15,95 €
930490	<input checked="" type="checkbox"/> angular trapeze Jet black RAL 9005 L x W x H: 75 x 75 x 22 mm	15,95 €
930493	<input checked="" type="checkbox"/> angular round Jet black RAL 9005 L x B x H: 75 x 75 x 22 mm	15,95 €



covers

930481	<input type="checkbox"/> round milky Traffic white RAL 9016 H x Ø: 22 x 78 mm	19,95 €
930500	<input type="checkbox"/> round square Traffic white RAL 9016 H x Ø: 22 x 78 mm	15,95 €
930497	<input type="checkbox"/> round step Traffic white RAL 9016 H x Ø: 22 x 78 mm	15,95 €
930503	<input type="checkbox"/> round trapeze Traffic white RAL 9016 H x Ø: 22 x 78 mm	15,95 €
930494	<input type="checkbox"/> round round Traffic white RAL 9016 H x Ø: 22 x 78 mm	15,95 €
930501	<input type="checkbox"/> round square White aluminium RAL 9006 H x Ø: 22 x 78 mm	15,95 €
930498	<input type="checkbox"/> round step White aluminium RAL 9006 H x Ø: 22 x 78 mm	15,95 €
930504	<input type="checkbox"/> round trapeze White aluminium RAL 9006 H x Ø: 22 x 78 mm	15,95 €
930495	<input type="checkbox"/> round round White aluminium RAL 9006 H x Ø: 22 x 78 mm	15,95 €
930502	<input checked="" type="checkbox"/> round square Jet black RAL 9005 H x Ø: 22 x 78 mm	15,95 €
930499	<input checked="" type="checkbox"/> round step Jet black RAL 9005 H x Ø: 22 x 78 mm	15,95 €
930505	<input checked="" type="checkbox"/> round trapeze Jet black RAL 9005 H x Ø: 22 x 78 mm	15,95 €
930496	<input checked="" type="checkbox"/> round round Jet black RAL 9005 H x Ø: 22 x 78 mm	15,95 €



LIGHT BASE

The LIGHT BASE series with its covers in three different versions, each in three colours, offers plenty of scope for accentuating objects.

The series is ideally suited as an orientation light and thus serves above all for safety. The covers direct the light downwards, creating glare-free yet effective lighting.

LIGHT BASE COB INDOOR

- aluminium diecast
- dimensions L x W x H x Ø: 85 x 85 x 36 x 79 mm
- dimmable via optional power supply unit
- incl. 4 x screws und 4 x dowels



563000 white

3000 K

152 lm

42,95 €

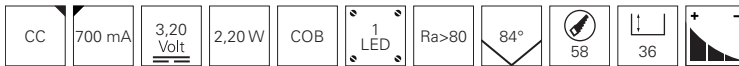

accessories

872027	power supply 700 mA 1,40 - 4,00 W	11,95 €
872015	power supply dimmable 700 mA 2,10 - 4,00 W	17,95 €
930127 <input type="checkbox"/>	cover angular oval Traffic white RAL 9016 L x W x H; 85 x 85 x 25 mm	10,95 €
930130 <input type="checkbox"/>	cover angular step Traffic white RAL 9016 L x W x H; 85 x 85 x 25 mm	10,95 €
930360 <input type="checkbox"/>	cover angular trapeze Traffic white RAL 9016 L x W x H; 85 x 85 x 25 mm	10,95 €
930357 <input type="checkbox"/>	cover round trapeze Traffic white RAL 9016 H x Ø: 38 x 85 mm	10,95 €
930128 <input type="checkbox"/>	cover angular oval Traffic grey RAL 7042 L x W x H; 85 x 85 x 25 mm	10,95 €
930131 <input type="checkbox"/>	cover angular step Traffic grey RAL 7042 L x W x H; 85 x 85 x 25 mm	10,95 €
930361 <input type="checkbox"/>	cover angular trapeze Traffic grey RAL 7042 L x W x H; 85 x 85 x 25 mm	10,95 €
930358 <input type="checkbox"/>	cover round trapeze Traffic grey RAL 7042 H x Ø: 38 x 85 mm	10,95 €
930129 <input checked="" type="checkbox"/>	cover angular oval Jet black RAL 9005 L x W x H; 85 x 85 x 25 mm	10,95 €
930132 <input checked="" type="checkbox"/>	cover angular step Jet black RAL 9005 L x W x H; 85 x 85 x 25 mm	10,95 €
930362 <input checked="" type="checkbox"/>	cover angular trapeze Jet black RAL 9005 L x W x H; 85 x 85 x 25 mm	10,95 €
930359 <input checked="" type="checkbox"/>	cover round trapeze Jet black RAL 9005 H x Ø: 38 x 85 mm	10,95 €



□ ■
page 204



□ ■
page 204



□ ■
page 206



□
page 207

reading lights





BRAHE I

- modern design
- completely individually adjustable via flexible arm
- optimal as reading light
- aluminium
- dimensions L x H x Ø: 310 x 80 x 25 mm
- socket L x W x H: 80 x 80 x 25 mm

341236	<input type="checkbox"/>	Traffic white RAL 9016	3000 K	175 lm	45,95 €
341237	<input checked="" type="checkbox"/>	Traffic black RAL 9017	3000 K	165 lm	45,95 €



suitable
table /
floor lights
page 210
346015
346016
343025
343026



BRAHE IV

- modern design
- direct and indirect lighting can be switched separately
- impresses with simplicity and elegance
- aluminium
- dimensions B x Ø: 110 x 150 mm
- primary light: 2,00 W / 1 LED
- ambient light: 4,80 W / 48 LED

341242	<input type="checkbox"/>	Traffic white RAL 9016	3000 K	490 lm	75,95 €
341243	<input checked="" type="checkbox"/>	Traffic black RAL 9017	3000 K	395 lm	75,95 €



suitable
table /
floor lights
page 210
346015
346016
343025
343026

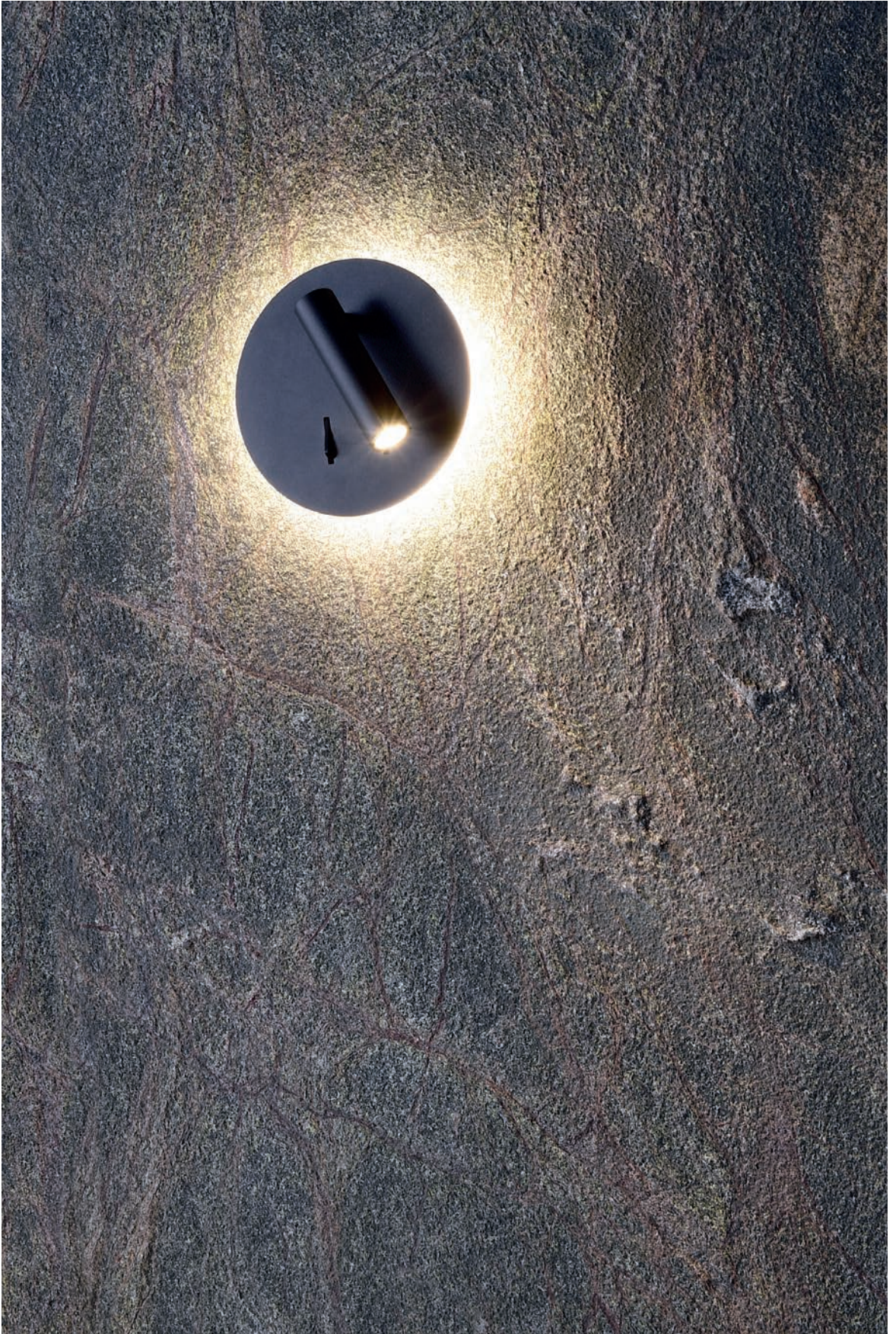



ALWA

The ALWA combines two luminaires in one sophisticated design: a bedside luminaire with indirect shade lighting and a reading spot. The highlight is the rotatable and swivelling arm [tilt angle: 90°], which enables the ALWA to provide targeted illumination. With its narrow beam angle of 20°, the ALWA also ensures that the person next to the bed is guaranteed not to be disturbed. We wish you a pleasant night's sleep.



ALWA I

- modern design
- flexible application possibilities due to rotatable luminaire body
- ideal as bed and reading lamp
- aluminium
- dimensions L x Ø: 110 x 30 mm
- socket L x W x H: 135 x 50 x 28 mm

341228	<input type="checkbox"/>	Traffic white RAL 9016	3000 K	200 lm	105,95 €
341229	<input checked="" type="checkbox"/>	Traffic black RAL 9017	3000 K	180 lm	105,95 €





BOA, 2ER SET.

- metal
- dimensions L x Ø: 400 x 20 mm
- socket B: 20 mm

920131 silver coloured mat

cw 6000 K

60 lm

75,95 €

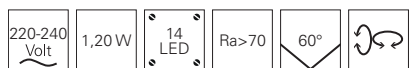



page 210



page 210

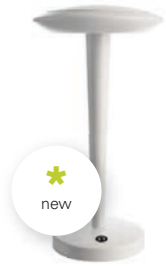

page 212



page 212



page 215



page 215



page 216



page 216



page 218



page 218

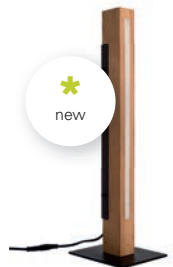

page 220

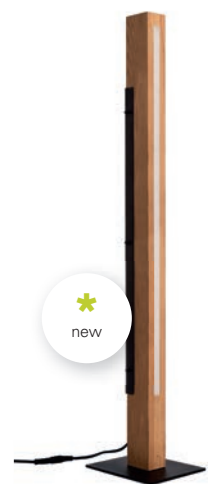

page 220

table and floor lights





BRAHE

- modern design
- direct and indirect lighting can be switched separately
- impresses with simplicity and elegance
- aluminium
- dimensions L x Ø: 455 x 150 mm
- primary light: 2,00 W / 1x LED
- ambient light: 4,80 W / 48x LED

346015 Traffic white RAL 9016  3000 K 470 lm **99,95 €**

346016 Traffic black RAL 9017  3000 K 370 lm **99,95 €**



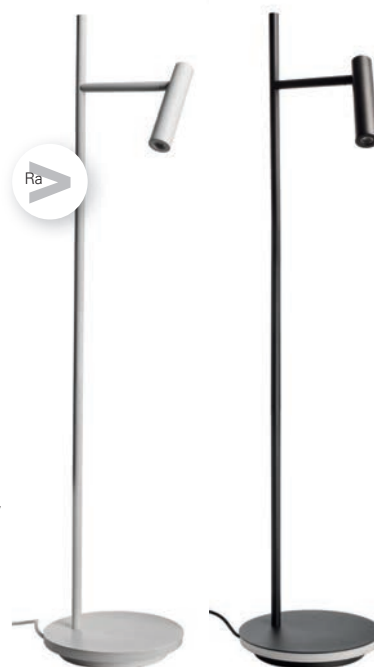

suitable
reading lights
page 204
341242
341243
341236
341237



BRAHE

- modern design
- direct and indirect lighting can be switched separately
- impresses with simplicity and elegance
- aluminium
- dimensions L x Ø: 1387 x 305 mm
- primary light: 3,00 W / 1x LED
- ambient light: 8,00 W / 72x LED

343025 Traffic white RAL 9016  3000 K 530 lm **179,95 €**

343026 Traffic black RAL 9017  3000 K 530 lm **179,95 €**



suitable
reading lights
page 204
341242
341243
341236
341237



BERMUDA

Whether as a decorative element or for reading – the 38 cm high BERMUDA table lamp can be switched between the light colours warm white, neutral white and cool white as well as dimmed via an integrated touch sensor.



suitable
wall lights
page 162
342159
342160



suitable
wall light
IP65
page 356
731124



suitable
bollard light
IP65
page 294
733056

BERMUDA

- Design by Johannes Tomm
- colour temperature selectable via touch switch
- ready to plug in / plug & play
- 360° beam angle
- aluminium diecast
- dimensions H x Ø: 380 x 200 mm
- socket H x Ø: 20 x 150 mm
- dimmable via touch sensor

346018	<input type="checkbox"/>	white		3000 / 4000 / 5000 K	935 lm	155,95 €
346017	<input checked="" type="checkbox"/>	Black grey RAL 7021		3000 / 4000 / 5000 K	935 lm	155,95 €



suitable
ground spike
lights
IP65
page 392
733060
733059

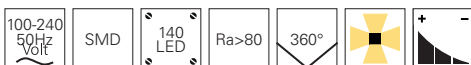

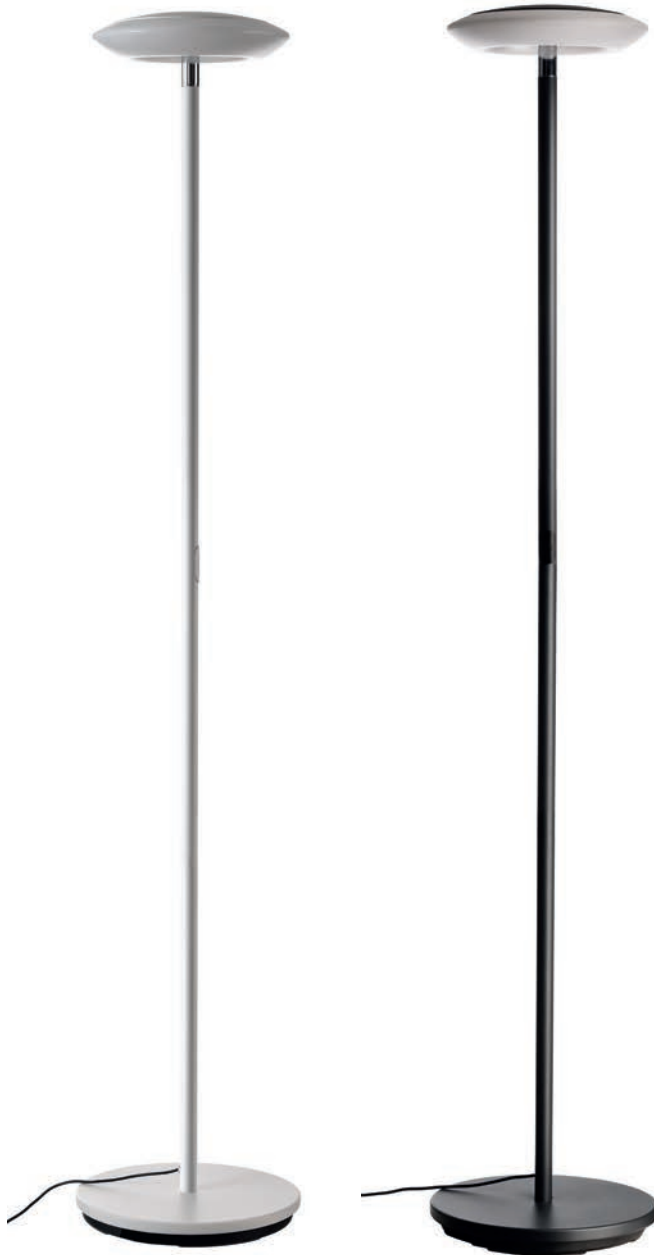

suitable
wall lights
page 162
342159
342160



suitable
wall light
IP65
page 356
731124





suitable
bollard light
IP65
page 294
733056



suitable
ground spike
lights
IP65
page 392
733060
733059

BERMUDA

- Design by Johannes Tomm
- Luminaire head can be tilted up to 30°
- ready to plug in / plug & play
- 360° beam angle
- aluminium diecast
- dimensions L x H: 1708 x 250 mm
- socket H x Ø: 26 x 250 mm
- dimmable via touch sensor

343029	<input type="checkbox"/>	white		3000 K	715 lm	165,95 €
343028	<input checked="" type="checkbox"/>	Black grey RAL 7021		3000 K	715 lm	165,95 €





ADHARA

Classic design interpreted in a modern way – the ADHARA made of aluminium impresses with its classic lines, state-of-the-art materials and high flexibility. Thanks to the three joints, ADHARA can be optimally adjusted to any situation. Its powerful LED module delivers 640/800 lumens and can also be dimmed thanks to the touch sensor. Whether in an executive's office or at a child's desk, ADHARA cuts a fine figure everywhere.

ADHARA SMALL

- practical design
- double adjustable and fixable via joints
- 3-level dimmable via touch sensor
- ready to plug in / plug & play
- aluminium
- dimensions L x Ø: 355 x 150 mm
- socket H x Ø: 16 x 160 mm



346030	<input type="checkbox"/>	white		3000 K	800 lm	99,95 €
346031	<input type="checkbox"/>	silver coloured		3000 K	800 lm	99,95 €
346029	<input type="checkbox"/>	black		3000 K	800 lm	99,95 €

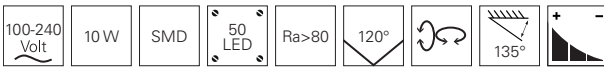

ADHARA

- practical design
- double adjustable and fixable via joints
- 3-level dimmable via touch sensor
- ready to plug in / plug & play
- aluminium
- dimensions L x H x Ø: 498 x 480 x 150 mm
- socket H x Ø: 22 x 180 mm



346027	<input type="checkbox"/>	white		3000 K	640 lm	149,95 €
346028	<input type="checkbox"/>	silver coloured		3000 K	640 lm	149,95 €
346026	<input type="checkbox"/>	black		3000 K	640 lm	149,95 €

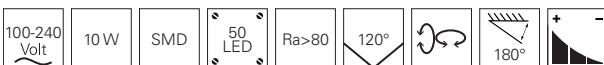

ASTEROPE

Light & shadow: Hardly any luminaire embodies this dualism more beautifully than the ASTEROPE in its various versions. The downward-opening pendant luminaire creates a multifaceted play of light and shadow on walls and ceilings that blends extravagantly yet harmoniously into any ambience.

Our tip: Combine the ASTEROPE with a gold-coloured or milky light source from the Filament series.



suitable
pendant lamps
page 47
342135
342136



suitable
wall lights
page 164
341216
341217

ASTEROPE LINEAR

- metal
- dimensions H x Ø: 450 x 150 mm
- socket H x Ø: 25 x 150 mm
- incl. 2 m connection cable with switch

346003 white matt **99,95 €**
346004 black matt **99,95 €**



suitable illuminants on page 974-977



suitable
pendant lamps
page 47
342135
342136



suitable
wall lights
page 164
341216
341217

ASTEROPE LINEAR

- metal
- dimensions H x Ø: 1600 x 210 mm
- socket H x Ø: 30 x 250 mm
- incl. 2,30 m connection cable with switch

343020 white matt **149,95 €**
343021 black matt **149,95 €**



suitable illuminants on page 974-977



TWISTER

Elegant design with innovative details meets unusual choice of materials: The TWISTER series combines decorative floor, table and pendant luminaires in different sizes, made entirely of plaster. We turn the cable into a design element! Completely in classic white, the luminaires are only interrupted by a red cable. This makes the TWISTER series an eye-catcher not only in living areas but also in hotels and restaurants.

TWISTER

- Design by Johannes Tomm
- red textile power cable
- gypsum
- easy cleaning through surface treatment
- dimensions H x Ø: 350 x 180 mm

346010 white

119,95 €



suitable illuminants on page 978



suitable
pendant lamps
page 70
342144
342145

TWISTER

- Design by Johannes Tomm
- red textile power cable
- gypsum
- easy cleaning through surface treatment
- dimensions L x H x Ø: 282 x 1500 x 280 mm
- socket H x Ø: 25 x 270 mm

343017 white

199,95 €



suitable illuminants on page 974-977



suitable
pendant lamps
page 70
342144
342145



MADERA

The MADERA series is made of first-class European oak wood and impresses with its modern design and mix of materials in private living areas, hotels, restaurants and many more. The noble MADERA luminaires distribute their powerful warm white light in any room and thus also cut an excellent figure as functional and high-quality lighting at reception counters and more.

MADERA

- modern, exclusive design
- manufactured in Europe from high-quality oak wood of grade A
- FSC-certified raw material oak wood
- environmentally friendly packaging
- infinitely dimmable via discreet touch sensor on the backside
- oak wood | aluminium
- dimensions L x W x H: 40 x 60 x 510 mm
- socket L x W x H: 160 x 130 x 6 mm

346044 ■ wood, black  3000 K 420 lm **285,95 €**

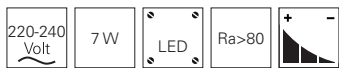

suitable ceiling light
page 113
348147



suitable pendant light
page 86
342169



suitable wall light
page 194
341248

MADERA

- modern, exclusive design
- manufactured in Europe from high-quality oak wood of grade A
- FSC-certified raw material oak wood
- environmentally friendly packaging
- infinitely dimmable via discreet touch sensor on the backside
- oak wood | aluminium
- dimensions L x W x H: 40 x 60 x 1410 mm
- socket L x W x H: 250 x 180 x 6 mm

343031 ■ wood, black  3000 K 1610 lm **445,95 €**

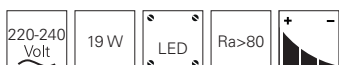

suitable ceiling light
page 113
348147



suitable pendant light
page 86
342169



suitable wall light
page 194
341248





■ □
page 224



□ □
page 225



□ □
page 226

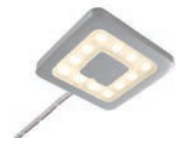

□ □
page 227



□ □
from page 228



□ □
page 230



□ □
page 231



□ □
page 232



□ □
page 233



□ □
from page 234



□
page 236



□
page 236



□
page 237

furniture lights

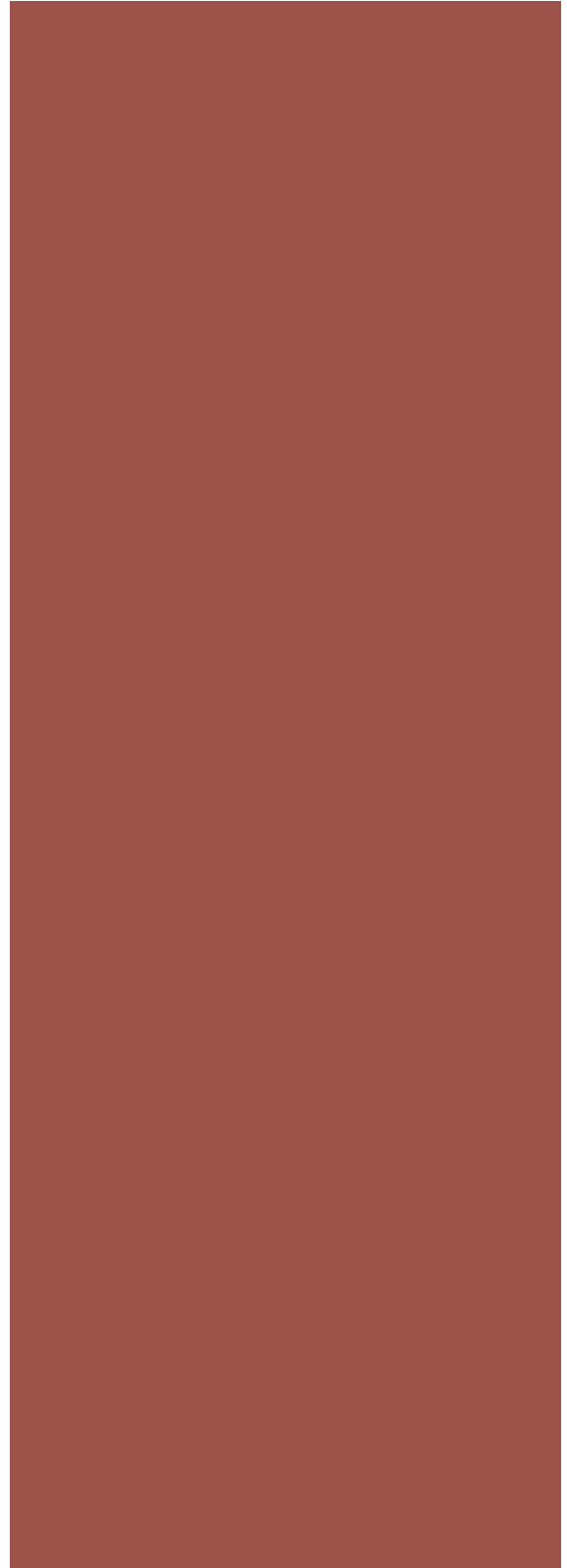

MIA

With their wide range of accessories, the versatile furniture luminaires of the MIA series offer the right solution for every situation. Whether in horizontal or vertical alignment – MIA convinces with its high light output and homogeneous illumination. It is conveniently controlled via touch dimmer or via a configurable PIR motion sensor.

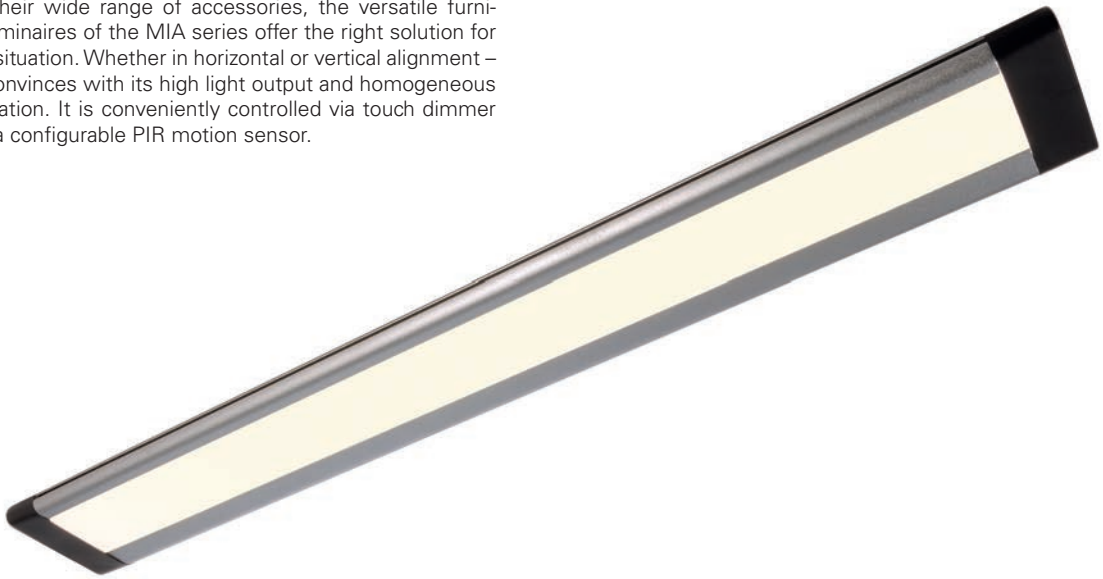

MIA

- aluminium
- dimensions B x H: 38 x 8 mm
- dimmable

687062		silver coloured / black	L: 300 mm		3000 K	210 lm	5 W	39,95 €
687064		silver coloured / black	L: 300 mm		4000 K	250 lm	5 W	39,95 €
687070		silver coloured / black	L: 500 mm		3000 K	330 lm	8 W	59,95 €
687071		silver coloured / black	L: 500 mm		4000 K	350 lm	8 W	59,95 €
687072		silver coloured / black	L: 1000 mm		3000 K	800 lm	14 W	106,95 €
687073		silver coloured / black	L: 1000 mm		4000 K	620 lm	14 W	106,95 €

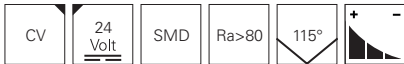

accessories

930212	touch dimmer black	9,95 €
930213	IR sensor black	20,95 €
930160	connector linear black	1,95 €
930191	angle connector flat black	2,95 €
930209	angle connector vertical black	3,95 €
687117	connection cable black 150 mm	1,95 €
687118	connection cable black 250 mm	1,95 €
930243	connection cable black 1000 mm	2,95 €
930242	mounting clips verstellbar set of 2 plastic transparent	3,95 €
930214	mounting clips set of 5 metal silver coloured	0,95 €
862037	power plug unit 24V DC 6 W 1,5 m cable	13,95 €
862038	power plug unit 24V DC 24 W 1,5 m cable	24,95 €
862074	power plug unit 24V DC 36 W 1,5 m cable	32,95 €



MIA

- aluminium
- dimensions B x H: 38 x 8 mm
- dimmable

687074	<input type="checkbox"/>	white	L: 300 mm	3000 K	210 lm	5 W	39,95 €
687075	<input type="checkbox"/>	white	L: 300 mm	4000 K	250 lm	5 W	39,95 €
687076	<input type="checkbox"/>	white	L: 500 mm	3000 K	330 lm	8 W	59,95 €
687077	<input type="checkbox"/>	white	L: 500 mm	4000 K	350 lm	8 W	59,95 €
687078	<input type="checkbox"/>	white	L: 1000 mm	3000 K	800 lm	14 W	106,95 €
687079	<input type="checkbox"/>	white	L: 1000 mm	4000 K	620 lm	14 W	106,95 €



accessories

930250	touch dimmer white	9,95 €
930251	IR sensor white	20,95 €
930247	connector linear white	1,95 €
930248	angle connector flat white	2,95 €
930249	angle connector vertical white	3,95 €
930244	connection cable white 150 mm	1,49 €
930245	connection cable white 250 mm	1,49 €
930246	connection cable white 1000 mm	2,95 €
930242	mounting clips verstellbar set of 2 plastic transparent	3,95 €
930214	mounting clips set of 5 metal silver coloured	0,95 €
862037	power plug unit 24V DC 6 W 1,5 m cable	13,95 €
862038	power plug unit 24V DC 24 W 1,5 m cable	24,95 €
862074	power plug unit 24V DC 36 W 1,5 m cable	32,95 €

PATY RUND

- aluminium
- dimensions H x Ø: 5 x 55 mm
- dimmable via leading or trailing edge



687059  Silver grey RAL 7001  3000 K 185 lm **30,95 €**

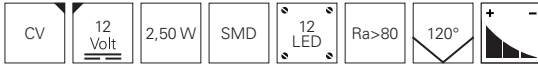

accessories

872127 power supply | 12V DC | 4,0 W **11,95 €**
872635 power supply | 12V DC | 20,0 W **22,95 €**
862051 power supply dimmable | 12V DC | 2,5 - 25,0 W **56,95 €**



PATY ROUND 3ER BUNDLE

- 3 x furniture surface-mounted luminaire PATY ROUND 687059
- dimensions H x Ø: 5 x 55 mm
- 1 x DEKO-LIGHT power supply 862169
- dimmable via leading or trailing edge
- incl. 6-fold AMP distributor [extension up to 6 luminaires]

620008  Silver grey RAL 7001  3000 K 3 x 185 lm **149,95 €**

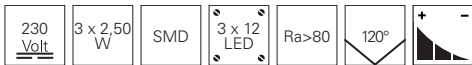

suitable pre-assembled accessories for extending the cabling on page 993



PATY ROUND 5ER BUNDLE

- 5 x furniture surface-mounted luminaire PATY ROUND 687059
- dimensions H x Ø: 5 x 55 mm
- 1 x DEKO-LIGHT power supply 862169
- dimmable via leading or trailing edge
- incl. 6-fold AMP distributor [extension up to 6 luminaires]

620009  Silver grey RAL 7001  3000 K 5 x 185 lm **214,95 €**

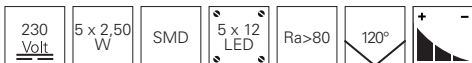

suitable pre-assembled accessories for extending the cabling on page 993

PATY ANGULAR

- aluminium

- dimensions L x W x H: 50 x 50 x 5 mm
- dimmable via leading or trailing edge

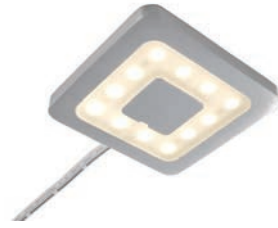

687039 silver coloured brushed 3000 K 160 lm **30,95 €**

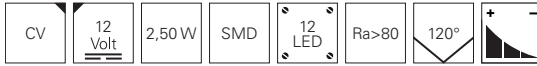

accessories

872127 power supply | 12V DC | 4,0 W **11,95 €**
872635 power supply | 12V DC | 20,0 W **22,95 €**
862051 power supply dimmable | 12V DC | 2,5 - 25,0 W **56,95 €**



PATY ANGULAR 3ER BUNDLE

- 3 x furniture surface-mounted luminaire PATY ECKIG 687039
- dimensions L x W x H: 50 x 50 x 5 mm
- 1 x DEKO-LIGHT power supply 862169
- dimmable via leading or trailing edge
- incl. 6-fold AMP distributor [extension up to 6 luminaires]

620010 silver coloured brushed 2700 K 3 x 160 lm **149,95 €**

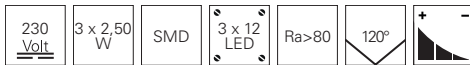

suitable pre-assembled accessories for extending the cabling on page 993



PATY ANGULAR 5ER BUNDLE

- 5 x furniture surface-mounted luminaire PATY ECKIG 687039
- dimensions L x W x H: 50 x 50 x 5 mm
- 1 x DEKO-LIGHT power supply 862169
- dimmable via leading or trailing edge
- incl. 6-fold AMP distributor [extension up to 6 luminaires]

620011 silver coloured brushed 2700 K 5 x 160 lm **214,95 €**

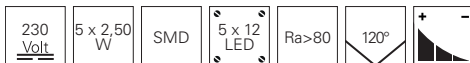

suitable pre-assembled accessories for extending the cabling on page 993



BAHAM I

- aluminium
- dimensions H x Ø: 12,50 x 62 mm
- dimmable via leading or trailing edge

687096 silver coloured brushed 3000 K 240 lm **29,95 €**



accessories

872127 power supply | 12V DC | 4,0 W **11,95 €**
872635 power supply | 12V DC | 20,0 W **22,95 €**
862051 power supply dimmable | 12V DC | 2,5 - 25,0 W **56,95 €**

SIMPLE, FAST, SAFE & POWERFUL

With our pre-assembled and ready-to-connect bundles, you are optimally prepared for current and future challenges in LED technology. In particular, carpenters as well as exhibition stand and shop fitters will find the right products for their ever-growing catalogue of requirements.

We are your partner when it comes to ready-to-plug-in solutions with high lumen packages. With our powerful bundles in numerous versions and configurations, customer requirements can be implemented quickly, efficiently and reliably.



BAHAM I 3ER BUNDLE

- 3 x surface-mounted/built-in furniture luminaire BAHAM I 687099
- dimensions H x Ø: 12,5 x 62 mm
- 1 x DEKO-LIGHT power supply dimmable 862169
- dimmable via leading or trailing edge
- incl. 6-fold AMP distributor [extension up to 6 luminaires]

620006 silver coloured brushed  3000 K 3 x 240 lm **129,95 €**

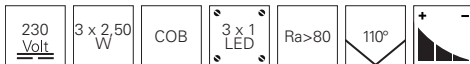

suitable pre-assembled accessories for extending the cabling on page 993



BAHAM I 5ER BUNDLE

- 5 x surface-mounted/built-in furniture luminaire BAHAM I 687099
- dimensions H x Ø: 12,5 x 62 mm
- 1 x DEKO-LIGHT power supply 862169
- dimmable via leading or trailing edge
- incl. 6-fold AMP distributor [extension up to 6 luminaires]

620007 silver coloured brushed  3000 K 5 x 240 lm **189,95 €**

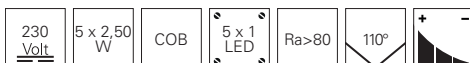

suitable pre-assembled accessories for extending the cabling on page 993

FINE I

- aluminium
- dimensions L x W x H: 60 x 60 x 5 mm
- dimmable via leading or trailing edge



687034  Silver grey RAL 7001 mat  2700 K 210 lm **29,95 €**



accessories

872127 power supply | 12V DC | 4,0 W **11,95 €**
872635 power supply | 12V DC | 20,0 W **22,95 €**
862051 power supply dimmable | 12V DC | 2,5 - 25,0 W **56,95 €**



FINE I 3ER BUNDLE

- 3 x furniture surface-mounted luminaire FINE I 687034
- dimensions L x W x H: 60 x 60 x 5 mm
- 1 x DEKO-LIGHT power supply 862169
- dimmable via leading or trailing edge
- incl. 6-fold AMP distributor [extension up to 6 luminaires]

620012  Silver grey RAL 7001 mat  3000 K 3 x 210 lm **149,95 €**

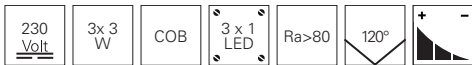

suitable pre-assembled accessories for extending the cabling on page 993



FINE I 5ER BUNDLE

- 5 x furniture surface-mounted luminaire FINE I 687034
- dimensions L x W x H: 60 x 60 x 5 mm
- 1 x DEKO-LIGHT power supply 862169
- dimmable via leading or trailing edge
- incl. 6-fold AMP distributor [extension up to 6 luminaires]

620013  Silver grey RAL 7001 mat  3000 K 5 x 210 lm **199,95 €**

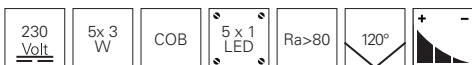

suitable pre-assembled accessories for extending the cabling on page 993

FINE II

- aluminium
- dimensions L x W x H: 190 x 60 x 5 mm
- dimmable via leading or trailing edge



687035 Silver grey RAL 7001 mat 2700 K 220 lm **34,95 €**



accessories

872127 power supply | 12V DC | 4,0 W **11,95 €**
872635 power supply | 12V DC | 20,0 W **22,95 €**
862051 power supply dimmable | 12V DC | 2,5 - 25,0 W **56,95 €**



FINE II 3ER BUNDLE

- 3 x furniture surface-mounted luminaire FINE II 687035
- dimensions L x W x H: 190 x 60 x 5 mm
- 1 x DEKO-LIGHT power supply 862169
- dimmable via leading or trailing edge
- incl. 6-fold AMP distributor [extension up to 6 luminaires]

620014 Silver grey RAL 7001 mat 2700 K 3 x 220 lm **169,95 €**

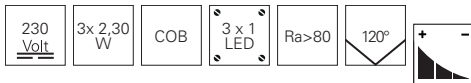

suitable pre-assembled accessories for extending the cabling on page 993



FINE II 5ER BUNDLE

- 5 x furniture surface-mounted luminaire FINE II 687035
- dimensions L x W x H: 190 x 60 x 5 mm
- 1 x DEKO-LIGHT power supply 862169
- dimmable via leading or trailing edge
- incl. 6-fold AMP distributor [extension up to 6 luminaires]

620015 Silver grey RAL 7001 mat 2700 K 5 x 220 lm **235,95 €**

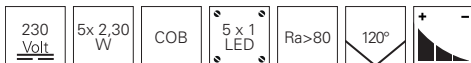

suitable pre-assembled accessories for extending the cabling on page 993

MIRROR ROUND

- aluminium
- dimensions L x H x Ø: 97 x 14 x 80 mm
- socket L x W: 30 x 15 mm
- dimmable via leading or trailing edge



687130 silver coloured chrome 4000 K 300 lm **49,95 €**



accessories

- 872629** power supply | 12V DC | 6,0 W **16,95 €**
872635 power supply | 12V DC | 20,0 W **22,95 €**
862051 power supply dimmable | 12V DC | 2,5 - 25,0 W **56,95 €**



ROUND 3ER BUNDLE

- 3 x furniture surface-mounted luminaire RUND 687130
- dimensions L x H x Ø: 97 x 14 x 80 mm
- 1 x DEKO-LIGHT power supply 862169
- dimmable via leading or trailing edge
- incl. 6-fold AMP distributor [extension up to 6 luminaires]

620016 silver coloured chrome 4000 K 3 x 300 lm **209,95 €**



suitable pre-assembled accessories for extending the cabling on page 993



ROUND 5ER BUNDLE

- 5 x furniture surface-mounted luminaire RUND 687130
- dimensions L x H x Ø: 97 x 14 x 80 mm
- 1 x DEKO-LIGHT power supply 862169
- dimmable via leading or trailing edge
- incl. 6-fold AMP distributor [extension up to 6 luminaires]

620017 silver coloured chrome 4000 K 5 x 300 lm **299,95 €**



suitable pre-assembled accessories for extending the cabling on page 993

MIRROR ANGULAR

- aluminium
- dimensions L x W x H: 98 x 80 x 14 mm
- socket L x W: 30 x 15 mm
- dimmable via leading or trailing edge



687131 silver coloured chrome NW 4000 K 300 lm **49,95 €**

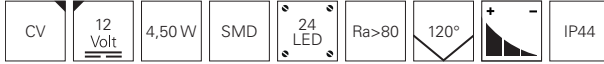

accessories

- 872629** power supply | 12V DC | 6,0 W **16,95 €**
872635 power supply | 12V DC | 20,0 W **22,95 €**
862051 power supply dimmable | 12V DC | 2,5 - 25,0 W **56,95 €**



ANGULAR 3ER BUNDLE

- 3 x furniture surface-mounted luminaire ANGULAR 687131
- dimensions L x W x H: 98x 80 x 14 mm
- 1 x DEKO-LIGHT power supply 862169
- dimmable via leading or trailing edge
- incl. 6-fold AMP distributor [extension up to 6 luminaires]

620018 silver coloured chrome NW 4000 K 3 x 300 lm **209,95 €**



suitable pre-assembled accessories for extending the cabling on page 993



ANGULAR 5ER BUNDLE

- 5 x furniture surface-mounted luminaire ANGULAR 687131
- dimensions L x W x H: 98 x 80 x 14 mm
- 1 x DEKO-LIGHT power supply 862169
- dimmable via leading or trailing edge
- incl. 6-fold AMP distributor [extension up to 6 luminaires]

620019 silver coloured chrome NW 4000 K 5 x 300 lm **299,95 €**

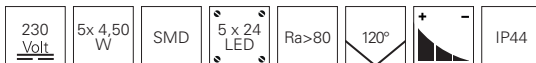

suitable pre-assembled accessories for extending the cabling on page 993



SPIEGEL LINE

Reflections in the most beautiful light: the LINE I and LINE II luminaires distribute their warm white light over a large area and without shading on mirrors up to 10 mm thick. If required, the LINE series can also be used as an elegant surface-mounted luminaire for various pieces of furniture using the adapter supplied.



MIRROR LINE I

- aluminium
- dimensions L x W x H: 312 x 100 x 67 mm
- socket L x W x H: 100 x 60 x 67 mm
- dimmable via leading or trailing edge
- incl. multi functional fixation
max. 10 mm deep [mirror, mounting]

687065  silver coloured chrome  3000 K 380 lm **69,95 €**

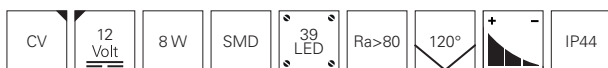



accessories

- 872632** power supply | 12V DC | 12,0 W **19,95 €**
872635 power supply | 12V DC | 20,0 W **22,95 €**
862051 power supply dimmable | 12V DC | 2,5 - 25,0 W **56,95 €**



LINE I 2ER BUNDLE

- 2 x furniture surface-mounted luminaire LINE I 687065
- dimensions L x W x H: 312 x 100 x 67 mm
- 1 x DEKO-LIGHT power supply dimmable 862170
- incl. 6-fold AMP distributor [extension up to 6 luminaires]

620020  silver coloured chrome  3000 K 2 x 380 lm **225,95 €**



suitable pre-assembled accessories for extending the cabling on page 993



MIRROR LINE II

- aluminium
- dimensions L x W x H: 512 x 100 x 67 mm
- socket L x W x H: 100 x 60 x 67 mm
- dimmable via leading or trailing edge
- incl. multi functional fixation
max. 10 mm deep [mirror, mounting]

687063 silver coloured chrome  3000 K 550 lm **89,95 €**

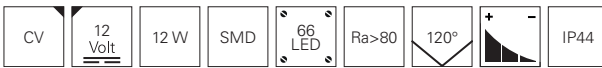

accessories

872635	power supply 12V DC 20,0 W	22,95 €
862162	power supply 12V DC 40,0 W	48,95 €
862051	power supply dimmable 12V DC 2,5 - 25,0 W	56,95 €



LINE II 2ER BUNDLE

- 2 x furniture surface-mounted luminaire LINE II 687063
- dimensions L x W x H: 512 x 100 x 67 mm
- 1 x DEKO-LIGHT power supply dimmable 862170
- incl. 6-fold AMP distributor [extension up to 6 luminaires]

620021 silver coloured chrome  3000 K 2 x 550 lm **249,95 €**





suitable pre-assembled accessories for extending the cabling on page 993



LUCY II

- aluminium
- dimensions L x W x H x Ø: 325 x 185 x 40 x 12 mm
- socket B: 35 mm
- dimmable via leading or trailing edge

688003  Silver grey RAL 7001  3000 K 400 lm **39,95 €**



accessories

- 872632** power supply | 12V DC | 12,0 W **19,95 €**
872635 power supply | 12V DC | 20,0 W **22,95 €**
862051 power supply dimmable | 12V DC | 2,5 - 25,0 W **56,95 €**

QUADRO POINT

- stainless steel
- dimensions L x W x H: 70 x 70 x 6,5 mm

686940  silver coloured brushed  4500 K 30 lm **32,95 €**



accessories

- 872127** power supply | 12V DC | 4,0 W **11,95 €**

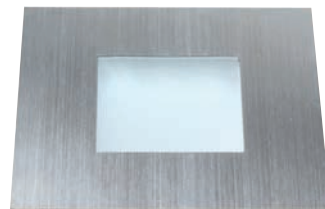



LUCKYLITE PRO - BATTERY POWERED

- plastic
- dimensions L x W x H: 100,0 x 10,6 x 70,0 mm
- motion sensor

687095 silver coloured mat **NW** 4000 K

49,95 €

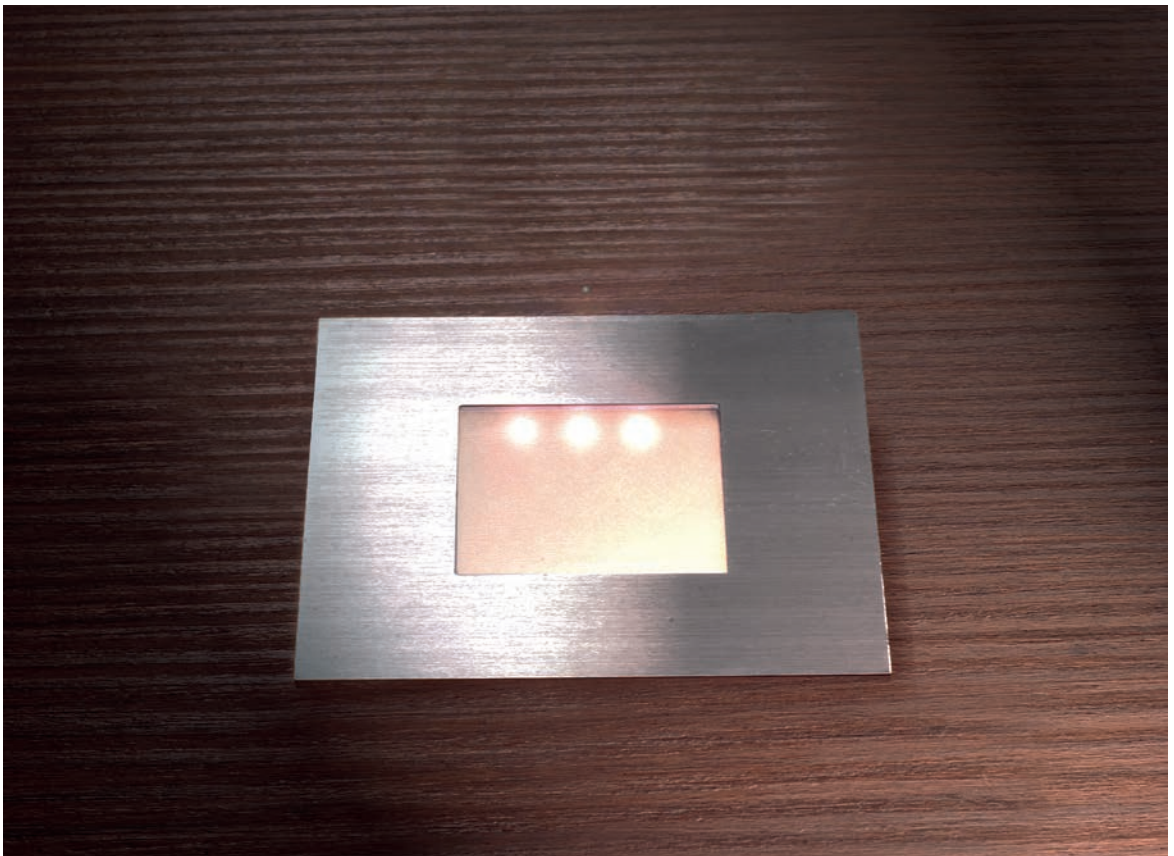
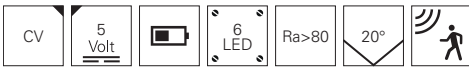

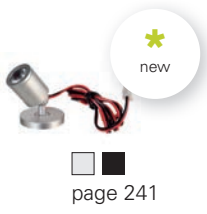

showcase lights



HERCULIS

Small helpers, big effect. With HERCULIS display luminaires in high-quality aluminium housings, you can reach all corners of a showcase. The luminaire head with its 40° beam angle can be freely rotated and swivelled in any direction. In addition, the intelligent cable routing and the ready-to-plug-in system allow easy surface and recessed mounting in showcases, counters, sales areas or in the living room.

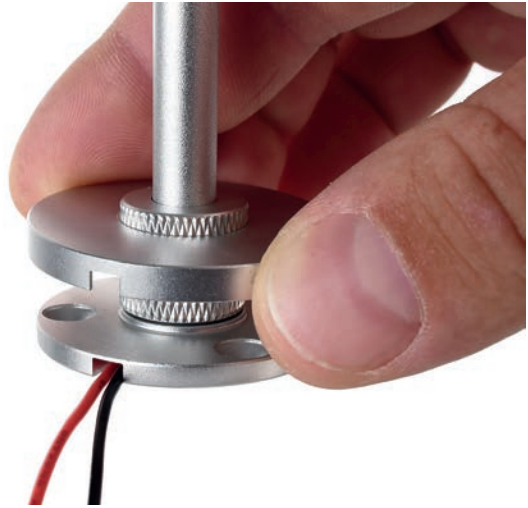

HERCULIS MAGNETIC

- design optimised for cabinets and showcases
- high performance despite compact design
- ready-to-plug-in system
- flexible mounting thanks to magnets

- aluminium diecast
- dimensions L x Ø: 42 x 31 mm
- socket H x Ø: 5 x 31 mm



688026		silver coloured		3000 K	100 lm	49,95 €
688025		black		3000 K	100 lm	49,95 €
688028		silver coloured		4000 K	105 lm	49,95 €
688027		black		4000 K	105 lm	49,95 €



accessories

930594	power supply, ready to plug in incl. 3-way distributor	25,95 €
930592	power supply, ready to plug in incl. 6-way distributor	35,95 €

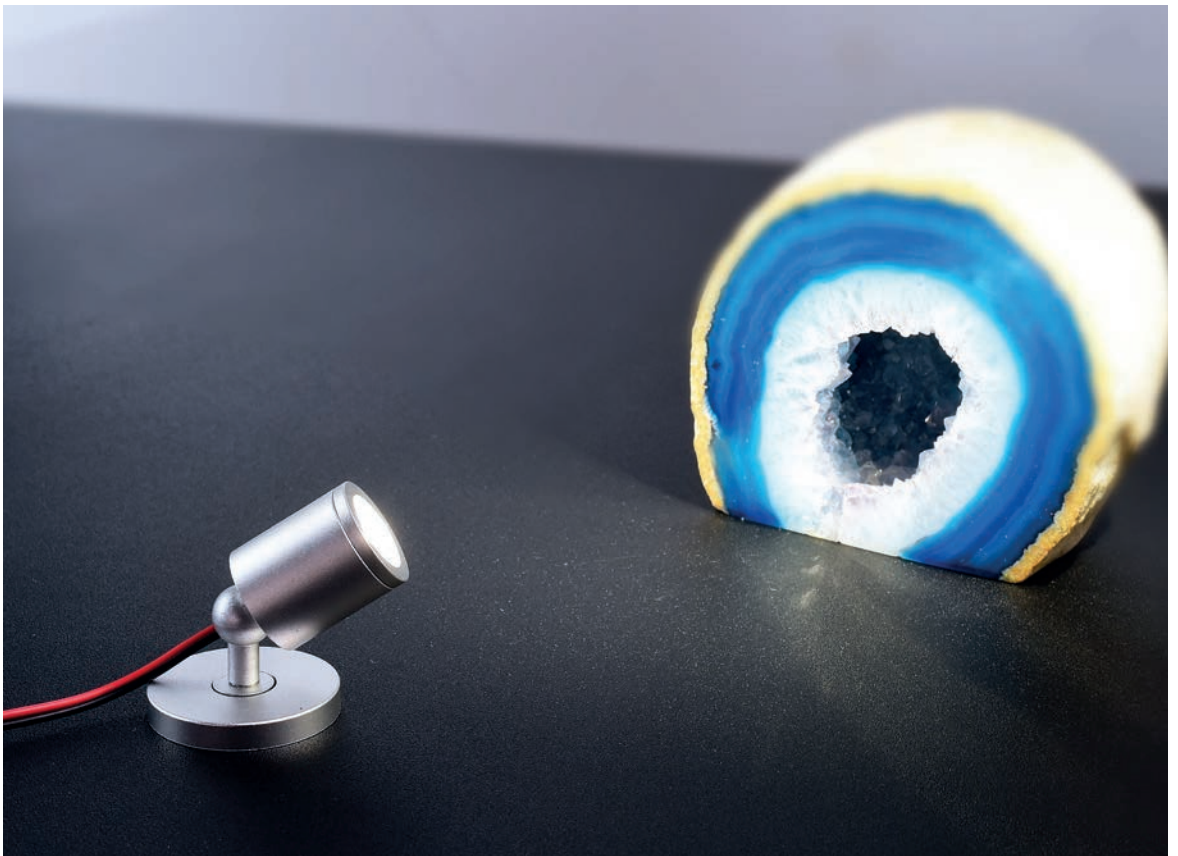

HERCULIS SMALL

- design optimised for cabinets and showcases
- high performance despite compact design
- for surface and recessed mounting thanks to intelligent cable routing
- ready-to-plug-in system
- rotatable and swivelling head
- aluminium diecast
- dimensions L x Ø: 150 x 39 mm
- socket H x Ø: 5 x 39 mm

688030		silver coloured		3000 K	100 lm	69,95 €
688029		black		3000 K	95 lm	69,95 €
688033		silver coloured		4000 K	95 lm	69,95 €
688031		black		4000 K	95 lm	69,95 €



accessories

930594	power supply, ready to plug in incl. 3-way distributor	25,95 €
930592	power supply, ready to plug in incl. 6-way distributor	35,95 €



HERCULIS BIG

- design optimised for cabinets and showcases
- high performance despite compact design
- for surface and recessed mounting thanks to intelligent cable routing
- ready-to-plug-in system
- rotatable and swivelling head
- aluminium diecast
- dimensions L x Ø: 250 x 39 mm
- socket H x Ø: 5 x 39 mm

688035		silver coloured		3000 K	95 lm	69,95 €
688034		black		3000 K	95 lm	69,95 €
688037		silver coloured		4000 K	98 lm	69,95 €
688036		black		4000 K	98 lm	69,95 €

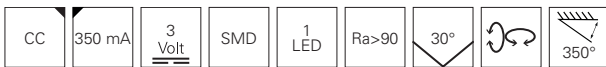

accessories

930594	power supply, ready to plug in incl. 3-way distributor	25,95 €
930592	power supply, ready to plug in incl. 6-way distributor	35,95 €





HERCULIS DOUBLE

- design optimised for cabinets and showcases
- high performance despite compact design
- for surface and recessed mounting thanks to intelligent cable routing
- ready-to-plug-in system
- rotatable and swivelling head
- aluminium diecast
- dimensions L x Ø: 200 x 39 mm
- socket H x Ø: 5 x 39 mm

688039		silver coloured		3000 K	185 lm	99,95 €
688038		black		3000 K	185 lm	99,95 €
688041		silver coloured		4000 K	195 lm	99,95 €
688040		black		4000 K	195 lm	99,95 €



accessories

930594	power supply, ready to plug in incl. 3-way distributor	25,95 €
930592	power supply, ready to plug in incl. 6-way distributor	35,95 €



HERCULIS TRIPLE

- design optimised for cabinets and showcases
- high performance despite compact design
- for surface and recessed mounting thanks to intelligent cable routing
- ready-to-plug-in system
- rotatable and swivelling head
- aluminium diecast
- dimensions L x Ø: 250 x 39 mm
- socket H x Ø: 5 x 39 mm

688043		silver coloured		3000 K	263 lm	119,95 €
688042		black		3000 K	263 lm	119,95 €
688045		silver coloured		4000 K	290 lm	119,95 €
688044		black		4000 K	290 lm	119,95 €



accessories

930594	power supply, ready to plug in incl. 3-way distributor	25,95 €
930592	power supply, ready to plug in incl. 6-way distributor	35,95 €







BATTERY AND SOLAR LIGHTS

248 battery lights

262 solar lights

OUTDOOR LIGHTS

270 bollard luminaires

298 surface mounted wall lights

358 ceiling and wall lights

368 built in wall lights

378 spherical and floor lamps

386 energy distributor

390 surface-mounted and ground spike lights

410 wall washer

416 ground recessed lights

450 underwater lights





battery and solar lights



MIRAM

Combine & shine – with the MIRAM series, there are no more limits to your creativity. Simply combine the luminaire head in your favourite colour with a stand, a wall bracket or a pendant fixture of your choice. In this way, you can create your very own individual luminaire in the twinkling of an eye and recombine it at any time without tools. Flexible, simple, chic - that is MIRAM combine & shine.

It's that simple:

- Choose a luminaire head in your favourite colour
- Select the desired fastening in your favourite colour

Your advantages:

- USB-C cable included
- 147 possible combinations



346025



346033



346032



346034



346035



346036



346037



930625



930627



930626



930628



930629



930630



930631



930618



930620



930619



930621



930622



930623



930624



930611



930613



930612



930614



930615



930616



930617





HEAD MAGNETIC LIGHT MIRAM

- high battery life [$>10\text{h}$]
- easy charging via USB-C cable [incl.]
- $>190\text{lm}$
- infinitely dimmable via touch switch
- can be combined with all brackets of the series thanks to magnetic attachment
- aluminium diecast
- dimensions H x \varnothing : 30 x 120 mm

346025		white		3000 K	196 lm	98,95 €
346033		grey		3000 K	196 lm	98,95 €
346032		black		3000 K	196 lm	98,95 €
346034		Ruby red RAL 3003		3000 K	196 lm	98,95 €
346035		yellow		3000 K	196 lm	98,95 €
346036		blue		3000 K	196 lm	98,95 €
346037		green		3000 K	196 lm	98,95 €



STAND FOR MAGNETIC LIGHT MIRAM

- can be combined as desired with any luminaire head from the MIRAM series
- aluminium diecast
- dimensions H x \varnothing : 270 x 102 mm







930611		white	28,95 €
930613		grey	28,95 €
930612		black	28,95 €
930614		Ruby red	28,95 €
930615		yellow	28,95 €
930616		blue	28,95 €
930617		green	28,95 €



WALL BRACKET FOR MAGNETIC LIGHT MIRAM

• can be combined as desired with any luminaire head from the MIRAM series

- aluminium diecast
- dimensions B x H: 85 x 96 mm
- socket Ø: 60 mm

930618		white	16,95 €
930620		grey	16,95 €
930619		black	16,95 €
930621		Ruby red RAL 3003	16,95 €
930622		yellow	16,95 €
930623		blue	16,95 €
930624		green	16,95 €









PENDANT FOR MAGNETIC LIGHT MIRAM

• can be combined as desired with any luminaire head from the MIRAM series

• mounting without drilling and screwing

- aluminium diecast
- dimensions B x H: 205 x 185 mm
- max. suspension: 2190 mm

930625		white	29,95 €
930627		grey	29,95 €
930626		black	29,95 €
930628		Ruby red RAL3003	29,95 €
930629		yellow	29,95 €
930630		blue	29,95 €
930631		green	29,95 €

CRUCIS

Powerful performance with a straightforward design: that is our CRUCIS rechargeable luminaire. Whether for a cosy get-together in the garden or as a discreet source of light in a restaurant or beer garden.

With its simple, timeless look, its long battery life and the charging base included in the scope of delivery, nothing stands in the way of a convivial evening outdoors – let alone an impractical cable.

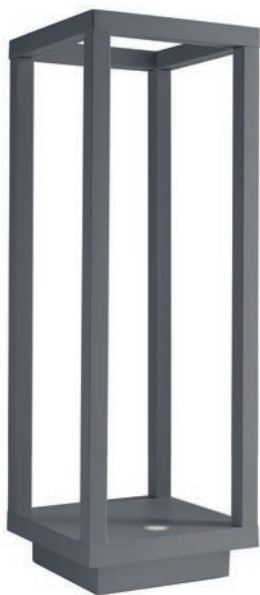
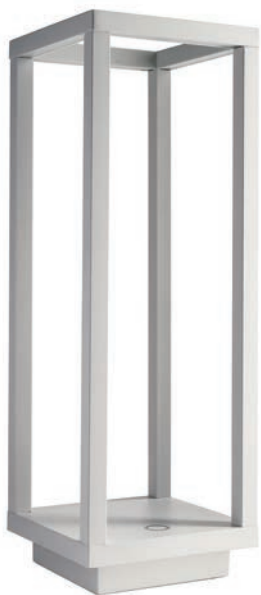

CRUCIS

- high battery life [>10h]
- easy charging via charging station with USB cable
- >160lm
- infinitely dimmable via touch switch
- aluminium diecast
- dimensions L x W x H: 100 x 100 x 292 mm
- socket L x W x H: 79 x 79 x 17 mm

346041	<input type="checkbox"/> white	<input checked="" type="checkbox"/> 3000 K	165 lm	99,95 €
346043	<input checked="" type="checkbox"/> grey	<input checked="" type="checkbox"/> 3000 K	165 lm	99,95 €
346042	<input checked="" type="checkbox"/> black	<input checked="" type="checkbox"/> 3000 K	165 lm	99,95 €





ALGIEBA

The smart table lamp with that certain something! Our battery lamp ALGIEBA not only impresses with its design and robust quality. It also offers that certain something for balmy summer nights outdoors thanks to an inductive charging panel that can be switched on via a touch switch!

No more battery problems or tangled cables. Even while charging your smartphone, the light performance does not suffer in the slightest.

The charging option of the included USB-C charging base completes the sophisticated concept of this unique battery light.

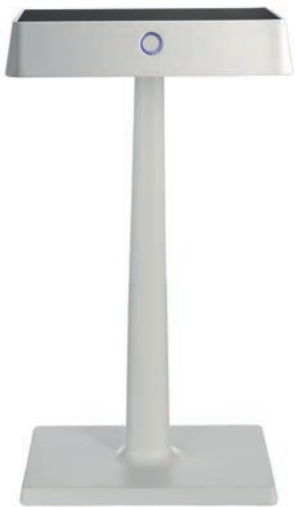

ALGIEBA

- high battery life [>10h]
if charging panel is not used
- easy charging via charging station with USB cable
- >200lm
- infinitely dimmable via touch switch
- switchable wireless charging panel for smartphones
- aluminium diecast
- dimensions L x W x H: 175 x 92 x 330 mm
- socket L x W x H: 175 x 103 x 15 mm

346038	<input type="checkbox"/> white	<input checked="" type="checkbox"/> 3000 K	212 lm	149,95 €
346040	<input checked="" type="checkbox"/> grey	<input checked="" type="checkbox"/> 3000 K	212 lm	149,95 €
346039	<input checked="" type="checkbox"/> black	<input checked="" type="checkbox"/> 3000 K	212 lm	149,95 €





SHERATAN

The SHERATAN is a battery-operated LED table lamp that can be charged via an integrated USB connection. This makes the SHERATAN suitable not only for use as accent light in living rooms, but also at events such as galas, corporate events and garden parties. The 38 cm high housing with wavy or smooth lampshade and stable base plate made of robust die-cast aluminium [IP54] houses a 2.2 watt LED bulb that produces a pleasant warm white light with 3000 K and can be switched on and off via a touch sensor.



SHERATAN I DIM

- touch dimmer
- noble look
- IP54
- aluminium diecast
- dimensions L x W x H x Ø: 100 x 100 x 380 x 110 mm
- socket L x W x H: 100 x 100 x 11 mm
- USB charging socket
- incl. lithium battery | 2x 2200 mAh

346011	<input type="checkbox"/> white	<input type="checkbox"/> 3000 K	154 lm	119,95 €
346012	<input checked="" type="checkbox"/> black	<input type="checkbox"/> 3000 K	154 lm	119,95 €



SHERATAN II DIM

- touch dimmer
- noble look
- IP54
- aluminium diecast
- dimensions L x W x H x Ø: 100 x 100 x 380 x 115 mm
- socket L x W x H: 100 x 100 x 11 mm
- USB charging socket
- incl. lithium battery | 2x 2200 mAh



346013	<input type="checkbox"/> white	<input type="checkbox"/> 3000 K	154 lm	119,95 €
346014	<input checked="" type="checkbox"/> black	<input type="checkbox"/> 3000 K	154 lm	119,95 €





LACERTAE USB

Be outside, have fun and simply take the light with you. No problem with this faithful companion. Thanks to its 3-stage dimming function, the LACERTAE USB is a favourite for cosy reading by the lake or a romantic picnic in the park. With the integrated power bank, it not only supports your garden party with light, but also ensures that the music doesn't run out of steam. The LACERTAE USB – a must-have for all those who want to be free.



LACERTAE USB

- portable
- powerbank function
- three-stage dimmable
- incl. 7800mAh lithium battery
- real glass panes
- aluminium diecast
- dimensions L x W x H: 180 x 180 x 267 mm
- socket L x W x H: 145 x 145 x 25 mm
- USB charging socket

346009 ■ dark grey ■ 3000 K 460 lm **155,95 €**



suitable
wall light
page 352
731112



SAMAS SOLAR

Not everywhere you want light, there is also electricity. We have the solution. The SAMAS SOLAR series only needs one thing to shine; sunshine every now and then. Thanks to its intelligent economy mode, in which it shines with only 15% light output when not in use, it has a particularly long burning time. As soon as it detects approach via its integrated sensor, it shines with full power. It can also be deactivated via a push-button. The powerful light output combined with the latest technology for long operating times is a real problem solver for walls, tables and gardens.



SAMAS SOLAR

- aluminium diecast
- dimensions L x W x H: 154 x 140 x 290 mm
- socket L x W x H: 110 x 30 x 12 mm
- motion / twilight switch
- highly efficient solar panel
- incl. Li-Ion battery | 3,70V | 2200 mA

731122 ■ dark grey  3000 K 130 lm **109,95 €**

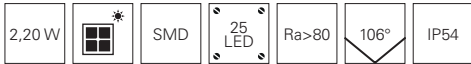







SAMAS SOLAR

- aluminium diecast
- dimensions L x W: 140 x 140 mm
- socket L x W x H: 100,50 x 100,50 x 22,00 mm
- motion / twilight switch
- incl. Li-Ion battery | 3,70V | 2200 mAh
- incl. ground spike

733049 ■ dark grey | H: 340 mm ■ 3000 K
733050 ■ dark grey | H: 500 mm ■ 3000 K

170 lm **99,95 €**
 135 lm **119,95 €**

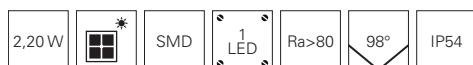

SOLAR PREMIUM

The SOLAR PREMIUM series impresses with its futuristic design and functions as an innovative and decorative outdoor luminaire in the outdoor and garden area. The power supply is provided by the integrated rechargeable battery including solar panel, so that no visually disturbing or complicated cables are necessary.

SOLAR PREMIUM I

- aluminium
- dimensions L x W x H: 160,5 x 233,2 x 152 mm
- socket L x W x H: 160,5 x 31,5 x 80,5 mm
- motion / twilight switch
- highly efficient solar panel
- incl. Li-Ion battery | 3,70V | 2200 mA

731116 ■ dark grey ■ 3200 K 170 lm **149,95 €**

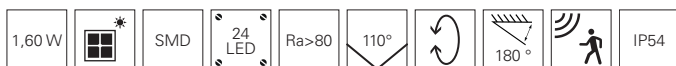

SOLAR PREMIUM I

- aluminium
- dimensions L x W x H: 200 x 151 x 1000 mm
- socket L x W x H: 80 x 151 x 4,5 mm
- motion / twilight switch
- highly efficient solar panel
- incl. Li-Ion battery | 3,70V | 2200 mA

733046 ■ dark grey ■ 3200 K 170 lm **179,65 €**

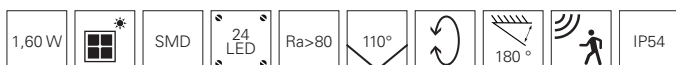





LUGH SOLAR

- aluminium diecast
- dimensions L x W x H: 140,5 x 140,5 x 340 mm
- socket L x W x H: 138,0 x 138,0 x 35,0 mm
- twilight switch
- power consumption: 2,20 W
- incl. Li-Ion battery | 3,70V | 2200 mAh

733051 ■ dark grey ■ 3000 K 130 lm **109,95 €**

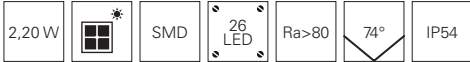





page



page 273



page 273



page 274



page 274



page 275



page 277



page 279



page 279



page 280



page 282



page 284



page 286



page 286



page 287



page 287



page 288



page 288



page 289



page 289



page 290



page 290



page 291



page 291



■ page 292



■ page 292



■ page 294



■ page 297

bollard lights



PORRIMA

- stainless steel
- dimensions Ø: 76 mm
- socket H x Ø: 8 x 118 mm
- dimmable via optional illuminants

733012 silver coloured brushed H: 500 mm **53,95 €**

733028 silver coloured brushed H: 1000 mm **63,95 €**



suitable illuminants on page 969-970



suitable
wall light
page 302
731107

NOVA

- stainless steel
- dimensions H x Ø: 1100 x 75 mm
- socket Ø: 110 mm
- dimmable via optional illuminants
- E27 socket suitable for A19 LED bulb

730007 silver coloured

67,95 €



suitable
wall lights
page 306
730034
731012

NOVA MOTION

- stainless steel
- dimensions H x Ø: 1100 x 75 mm
- socket Ø: 110 mm
- motion / twilight switch
- E27 socket suitable for A19 LED bulb

730032 silver coloured

74,95 €



suitable
wall lights
page 306
730034
731012

ZILLY II

- stainless steel
- dimensions L x W: 500 x 140 mm
- socket H x Ø: 7 x 100 mm
- dimmable via optional illuminants

733002  silver coloured

74,95 €



suitable illuminants on page 969-970



suitable
wall lights
page 303
731008
731009

ZILLY II

- stainless steel
- dimensions L x W: 1000 x 232 mm
- socket H x Ø: 7 x 100 mm
- dimmable via optional illuminants

733003  silver coloured

104,95 €



suitable illuminants on page 969-970



suitable
wall lights
page 305
731010
731011

ESTADA

- stainless steel
- dimensions H x Ø: 1000 x 100 mm
- socket Ø: 170 mm
- dimmable via optional illuminants

730009  silver coloured

104,95 €



suitable illuminants on page 974-977



suitable
wall light
page 308
730014





ARBINTO

The ARBINTO with its high standing base and the light emission with E27 bulb as well as real glass frame reminds of a torch and creates an immediate feeling of warmth and security.

ARBINTO

- aluminium diecast
- dimensions L x W: 800 x 120 mm
- socket Ø: 140 mm
- dimmable via optional illuminants

733061 ■ Black grey RAL 7021

106,95 €



suitable illuminants on page 974-977



FACADO

The floor lamps of the Facado series [IP44] in two heights [65 cm / 100 cm] flank the paved walkways in the garden area and function equally as functional and classically elegant path lighting.

FACADO A + B

- aluminium diecast
- dimensions L x W x H: 108 x 108 x 650 mm
- socket L x W: 108 x 108 mm
- dimmable via optional illuminants

730332 ■ anthracite **109,95 €**
730333 ■ brown **109,95 €**



suitable illuminants on page 974-977



FACADO A

- aluminium diecast
- dimensions L x W x H: 110 x 110 x 1000 mm
- socket L x W x H: 110 x 110 x 10 mm
- dimmable via optional illuminants

733018 ■ anthracite **164,95 €**



suitable illuminants on page 974-977



suitable
wall light
page 308
731059



CATA IV

- aluminium diecast
- dimensions L x W: 151 x 61 mm
- socket L x W x H: 145 x 55 x 20 mm

733040	■ anthracite	H: 500 mm	☀ 3000 K	170 lm	159,95 €
733041	■ anthracite	H: 700 mm	☀ 3000 K	170 lm	185,95 €
733042	■ anthracite	H: 1000 mm	☀ 3000 K	170 lm	205,95 €

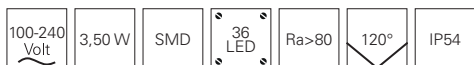





HYDRAE

With the HYDRAE LED bollard luminaire, various outdoor scenarios can be elegantly and efficiently illuminated. Developed for outdoor use, the designer luminaire made of combined die-cast aluminium and stainless steel is suitable for path lighting or as a decorative lighting element in the garden area. In addition to the bollard luminaire version, the HYDRAE product family also includes a wall-mounted luminaire.



HYDRAE

- aluminium diecast
- dimensions L x W: 160 x 49 mm
- socket L x W x H: 150 x 40 mm

733052 ■ anthracite H: 650 mm  3000 K 600 lm **169,95 €**
733053 ■ anthracite H: 1000 mm  3000 K 600 lm **192,95 €**

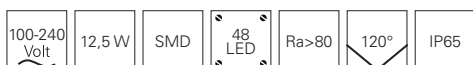

suitable
wall light
page 317
731103



CHERTAN

With its unusual material mix of die-cast aluminium housing and a concrete base, the CHERTAN outdoor floor lamp stands out visually from other models. With its pleasant warm white light and a beam angle of 120° including motion and twilight switch, the outdoor luminaire is perfect for decorative use in entrance areas, on walkways or in the garden.



CHERTAN

- aluminium diecast | Beton
- dimensions L x W: 170 x 72 mm
- socket L x W x H: 160 x 30 x 40 mm

733043	■ dark grey	H: 450 mm	ww 3000 K	480 lm	182,95 €
733044	■ dark grey	H: 600 mm	ww 3000 K	530 lm	199,95 €
733045	■ dark grey	H: 1000 mm	ww 3000 K	640 lm	219,95 €

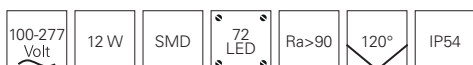

suitable
wall light
page 318
731113

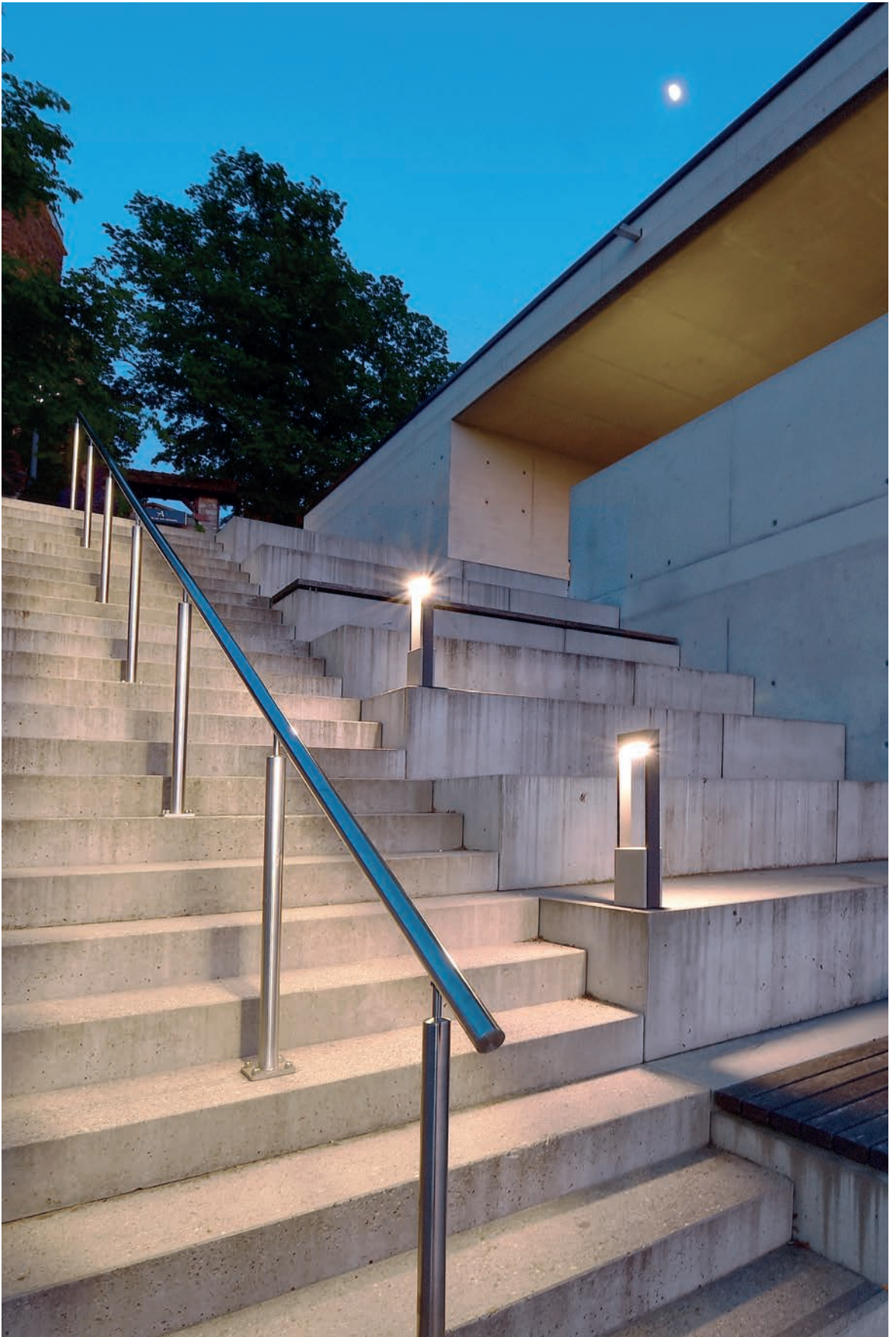

RUKBAT

- aluminium diecast
- dimensions L x W: 85 x 85 mm
- socket L x W x H: 145 x 145 x 20 mm

733047 ■ Traffic grey B RAL 7043

H: 500 mm  3000 K

670 lm **149,95 €**

733048 ■ Traffic grey B RAL 7043

H: 800 mm  3000 K

670 lm **195,95 €**



ANTLIAE

- aluminium diecast
- dimensions L x W: 152 x 121 mm
- socket L x W x H: 152 x 121 x 20 mm

733033 ■ Traffic grey B RAL 7043

H: 150 mm  3000 K

380 lm **99,95 €**

733034 ■ Traffic grey B RAL 7043

H: 500 mm  3000 K

650 lm **129,95 €**

733035 ■ Traffic grey B RAL 7043

H: 800 mm  3000 K

650 lm **149,95 €**



TRILA

- aluminium diecast
- dimensions L x W x H: 128,5 x 123 x 800 mm
- socket Ø: 120 mm

730364 ■ anthracite  3000 K

361 lm **149,95 €**



suitable
wall light
page 347
730366

TRILA II

- aluminium diecast
- dimensions L x W x H: 128,5 x 123 x 800 mm
- socket Ø: 120 mm

730365 ■ anthracite  3000 K

361 lm **149,95 €**



suitable
wall light
page 347
730366

ORTIS

- aluminium diecast
- dimensions L x Ø: 1000 x 120 mm

733004 ■ dark grey ■ ww 3000 K 510 lm **189,95 €**

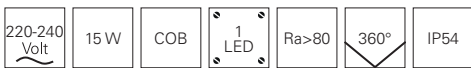

suitable
wall light
page 346
731031

BESSMA II + III

- aluminium diecast
- dimensions Ø: 80 mm
- socket H x Ø: 30 x 100 mm

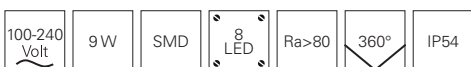

733025 ■ Traffic grey B RAL 7043 H: 500 mm ■ ww 3000 K 580 lm **105,95 €**
733026 ■ Traffic grey B RAL 7043 H: 800 mm ■ ww 3000 K 580 lm **125,95 €**



suitable
wall light
page 347
731083

BEACON II MOTION

- aluminium diecast
- dimensions L x W: 70 x 70 mm
- socket L x W x H: 102 x 102 x 7 mm
- motion / twilight switch

733006 ■ Traffic grey B RAL 7043 H: 500 mm  3000 K 290 lm **129,95 €**
733008 ■ Traffic grey B RAL 7043 H: 800 mm  3000 K 290 lm **149,95 €**



suitable
wall light
page 345
731016

GRUIS II

- aluminium diecast
- dimensions L x W x H: 20 x 80 x 650 mm
- socket L x W x H: 117 x 65 x 11 mm

733005 ■ anthracite  3000 K 310 lm **125,95 €**

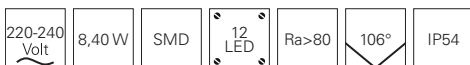

suitable
wall light
page 344
731055

IRETTA

- aluminium diecast
- dimensions L x W x H: 165 x 192 x 700 mm
- socket L x W: 165 x 85 mm

730354 ■ anthracite  3000 K 240 lm **149,95 €**



suitable
wall light
page 345
730395



reddot award 2017
winner

ROBI FLEX

- aluminium diecast
- dimensions L x W x H: 35 x 80 x 1000 mm
- socket L x W: 115 x 73 mm
- tiltable light head

733007 ■ dark grey lackiert  3000 K 700 lm **209,95 €**

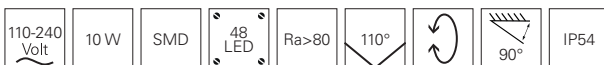

suitable
wall light
page 343
731068



TAYGETA 600 + 1000

- aluminium diecast
- dimensions L x W: 220 x 148 mm
- socket L x W x H: 220 x 90 x 10 mm

733037 ■ dark grey H: 600 mm  3000 K 1500 lm **209,95 €**
733038 ■ dark grey H: 1000 mm  3000 K 1500 lm **239,95 €**



TAYGETA 1000 MOTION

- aluminium diecast
- dimensions L x W x H: 220 x 148 x 1000 mm
- socket L x W x H: 220 x 90 x 10 mm
- motion / twilight switch

733039 ■ dark grey  3000 K 1500 lm **259,95 €**

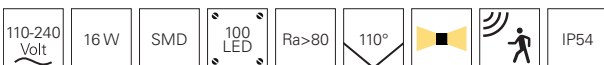

TUCANAE

- aluminium diecast
- dimensions B x H: 206 x 1000 mm
- socket L x W x H: 120 x 180 x 10 mm

733031 ■ dark grey ■ 3000 K 1650 lm **219,95 €**



suitable wall light
page 342
731110

TUCANAE MOTION

- aluminium diecast
- dimensions B x H: 206 x 1000 mm
- socket L x W x H: 120 x 180 x 10 mm
- motion / twilight switch

733036 ■ dark grey ■ 3000 K 1650 lm **239,95 €**



suitable wall light
page 342
731115

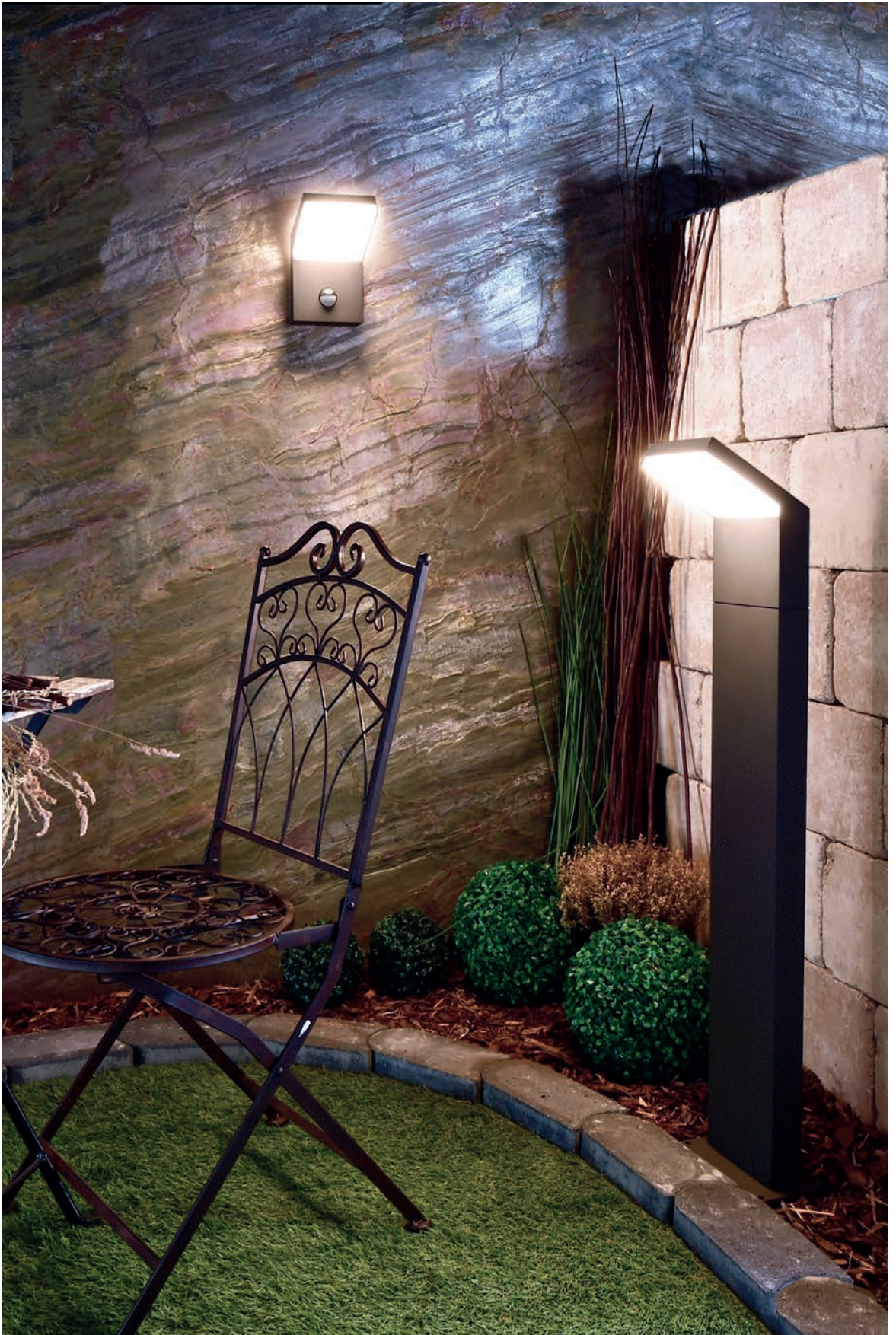

BERMUDA

Admittedly, a big name for a small luminaire. But in its design, the BERMUDA series undoubtedly presents itself as exciting as the well-known triangle. The small light dwarf is an enrichment for every garden and fits like a small mushroom into every outdoor environment. And by the way, it also cuts a fine figure as a wall luminaire.



suitable
wall light
IP65
page 356
731124



suitable
ground spike
lights
IP65
page 392
733060
733059



suitable
wall lights
page 162
342159
342160



suitable
table /
floor lights
page 212
346018
346017
343029
343028

BERMUDA

- Design by Johannes Tomm
- eye-catching outdoor lighting
- 360° beam angle
- aluminium diecast
- dimensions L x Ø: 600 x 200 mm
- dimmable via leading or trailing edge

733056 ■ Black grey RAL 7021  3000 K 600 lm **199,95 €**

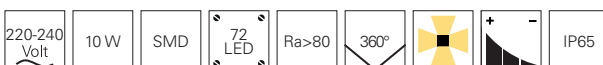





With the kind support of Arte Classica Schirzel / www.arte-classica.de

ALHENA

Thanks to its SMD construction, the modern, towering ALHENA luminaire with 360° light distribution not only illuminates driveways, car parks, gardens or terraces, but also appears as a design element itself.

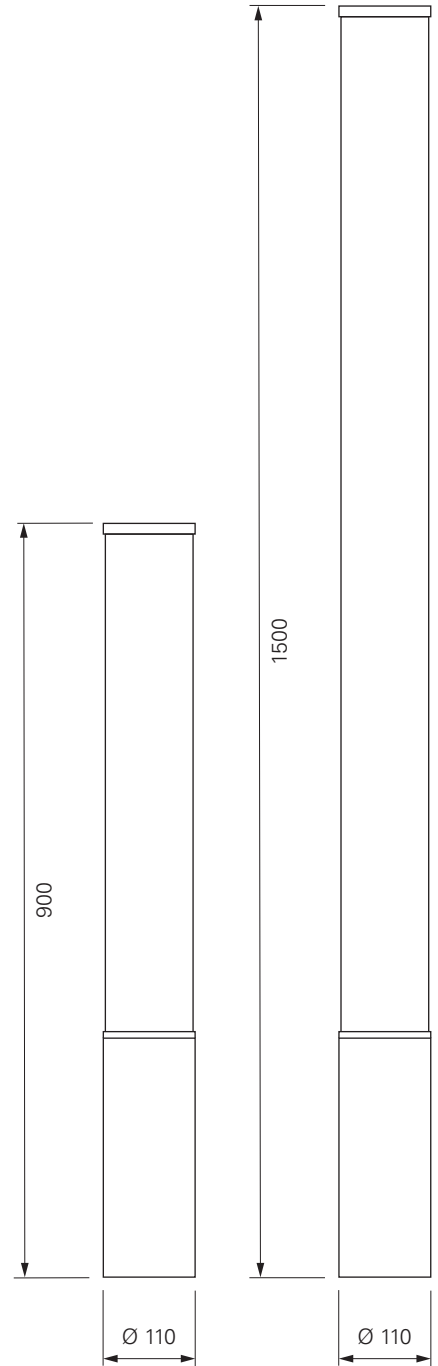

ALHENA

- timeless design
- high light output
- strong statement for expressive outdoor areas
- aluminium diecast
- dimensions Ø: 110 mm
- socket Ø: 130 mm

733057	■ Black grey RAL 7021	H: 900 mm	ww 3000 K	2965 lm	219,95 €
733058	■ Black grey RAL 7021	H: 1500 mm	ww 3000 K	3900 lm	299,95 €





□ page 302



□ page 302



□ page 303



□ page 303



□ page 303



□ page 304



□ page 304



□ page 305



□ page 305



□ page 306



□ page 306



□ page 308



■ page 308



■ page 309



■ page 310

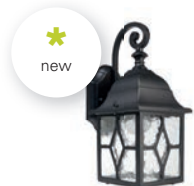

■ page 310



■ page 312



■ page 312



■ ■ page 314



■ page 315



■ page 316



□ page 317



■ page 318



■ page 320



■ page 321



■ page 321



new



■ □ page 323



new



■ □ page 323



■ page 325



■ page 325



■ page 326



■ page 327



■ ■ ■ page 328



■ page 329



■ page 329

surface mounted wall lights



□ □ ■
page 330



□ □ ■
page 330



■
page 332



■
page 332



■
page 334



■
page 334



■
page 334



■ □
page 335



■ □
page 335



■
page 337

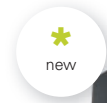

■
page 337



■
page 338



■
page 338



■ □
page 341



■ □
page 341



■
page 342



■
page 342



■
page 343



■
page 344



■
page 344



■
page 345



■
page 345



■
page 346



■ page 347

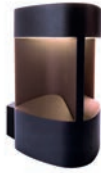

■ page 347



■ page 348



■ page 348



■ page 349



■ page 350



■ page 350



■ page 351



■ page 352



■ page 353



■ □ page 354



■ page 355



■ page 356



WALL I

- stainless steel
- dimensions L x W x H: 230 x 92 x 290 mm
- socket L x W: 200 x 260 mm
- dimmable via optional illuminants

948109  silver coloured **39,95 €**



accessories

948139 numbers set | numbers each 3x [0 to 9] and letters each 1x [A to J] **9,95 €**

suitable illuminants on page 974-977



PORRIMA II

- stainless steel
- dimensions L x W x H x Ø: 255 x 142 x 85 x 76 mm
- socket H x Ø: 25 x 85 mm
- dimmable via optional illuminants

731107  silver coloured brushed **42,95 €**



suitable illuminants on page 969-970



suitable
bollard lights
page 272
733012
733028

ZILLY DOWN

- stainless steel
- dimensions L x W x H x Ø: 115 x 115 x 107 x 60 mm
- socket L x W x H: 80 x 50 x 25 mm
- dimmable via optional illuminants

731005  silver coloured **33,95 €**



suitable illuminants on page 969-970



ZILLY II DOWN

- stainless steel
- dimensions L x W x H x Ø: 125 x 60 x 105 x 60 mm
- socket L x W x H: 100 x 43 x 22 mm
- dimmable via optional illuminants

731008  silver coloured **45,95 €**



suitable illuminants on page 969-970



suitable
bollard light
page 274
733002

ZILLY II DOWN MOTION

- stainless steel
- dimensions L x W x H x Ø: 150 x 68 x 106 x 60 mm
- socket L x W x H: 150 x 68 x 27 mm
- motion / twilight switch

731009  silver coloured **72,95 €**



suitable illuminants on page 969-970



suitable
bollard light
page 274
733002



ZILLY UP & DOWN

- stainless steel
- dimensions L x W x H x Ø: 163 x 107 x 60 x 60 mm
- socket L x W x H: 80 x 50 x 27 mm
- dimmable via optional illuminants

731006  silver coloured **49,95 €**



suitable illuminants on page 969-970



ZILLY UP & DOWN MOTION

- stainless steel
- dimensions L x W x H x Ø: 215 x 110 x 70 x 60 mm
- socket L x W x H: 150 x 68 x 27 mm
- motion / twilight switch

731007  silver coloured **77,95 €**



suitable illuminants on page 969-970

ZILLY II UP AND DOWN

- stainless steel
- dimensions L x W x H x Ø: 178 x 60 x 105 x 60 mm
- socket L x W x H: 102 x 42 x 22 mm
- dimmable via optional illuminants

731010  silver coloured **77,95 €**

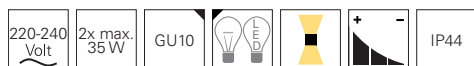

suitable illuminants on page 969-970



suitable
bollard light
page 274
733003

ZILLY II UP AND DOWN MOTION

- stainless steel
- dimensions L x W x H x Ø: 220 x 70 x 108 x 60 mm
- socket L x W x H: 148 x 67 x 25 mm
- motion / twilight switch

731011  silver coloured **89,95 €**

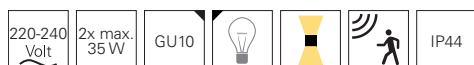

suitable illuminants on page 969-970



suitable
bollard light
page 274
733003

NOVA III

- stainless steel
- dimensions L x W x H x Ø: 331 x 105 x 60 x 60 mm
- socket L x W x H: 103 x 42 x 23 mm
- dimmable via optional illuminants
- E27 socket suitable for A19 LED bulb

731012  silver coloured **52,95 €**



passende GU10 Leuchtmittel auf page 969-970



suitable
bollard light
page 273
730007

NOVA II

- stainless steel
- dimensions L x W x H x Ø: 388 x 145 x 110 x 75 mm
- socket H x Ø: 25 x 110 mm
- motion / twilight switch
- E27 socket suitable for A19 LED bulb

730034  silver coloured **59,95 €**



suitable
bollard light
page 273
730032





ESTADA II

- stainless steel
- dimensions L x W x H: 102 x 170 x 220 mm
- dimmable via optional illuminants

730014  silver coloured **59,95 €**



suitable illuminants on page 974-977



suitable
bollard light
page 275
730009



FACADO A

- aluminium diecast
- dimensions L x W x H: 243 x 110 x 150 mm
- socket L x W x H: 120 x 90 x 35 mm
- dimmable via optional illuminants

731059  anthracite **85,95 €**



suitable illuminants on page 974-977



suitable
bollard light
page 279
733018

ADEBAR MOTION

- timeless design
- exchangeable bulb E27 [Retrofit]
- can also be used indoors
- aluminium diecast
- dimensions L x Ø: 218 x 160 mm
- motion sensor

731137  grey

96,95 €



suitable illuminants on page 974-977



SAIPH & SARGAS

The classic outdoor luminaires combine proven luminaire design from over 100 years with modern conveniences. The timeless wall-mounted luminaires of the new SAIPH and SARGAS series evoke reminiscences of iconic designs from various decades and impress with high-quality real glass that is not only resistant to scratches but also weather and UV-resistant.



SAIPH

- rustic design
- exchangeable bulb E27 [Retrofit]
- aluminium
- dimensions L x W x H: 170 x 149 x 280 mm
- dimmable via optional illuminants

341244 ■ black

45,95 €



suitable illuminants on page 974-977



SARGAS

- rustic design
- exchangeable bulb E27 [Retrofit]
- aluminium
- dimensions L x W x H: 178 x 151 x 318 mm
- dimmable via optional illuminants

341245 ■ black

45,95 €



suitable illuminants on page 974-977





ACHERNAR DOWN

- timeless design
- replaceable **GU10 bulb [Retrofit]**
- can also be used indoors
- aluminium diecast
- dimensions L x H x Ø: 108 x 95 x 63 mm
- dimmable via optional illuminants

731130 ■ Black grey RAL 7021

36,95 €



suitable illuminants on page 969-970



ACHERNAR UP AND DOWN

- timeless design
- replaceable **GU10 bulb [Retrofit]**
- can also be used indoors
- aluminium diecast
- dimensions L x H x Ø: 158 x 95 x 63 mm
- dimmable via optional illuminants

731131 ■ Black grey RAL 7021

47,95 €



suitable illuminants on page 969-970





RILONGO

- aluminium diecast
- dimensions L x W x H: 250 x 110 x 103 mm
- socket L x W: 250 x 110 mm
- dimmable via optional illuminants

730330 ■ Basalt grey RAL 7012 **64,95 €**

730331 ■ brown **64,95 €**



suitable illuminants on page 974-977





WALL LINE III

- aluminium diecast
- dimensions L x W x H: 250 x 110 x 110 mm
- socket L x W: 250 x 103 mm
- dimmable via optional illuminants

731060 ■ anthracite

64,95 €



suitable illuminants on page 974-977





HYDRAE

- stainless steel
- dimensions L x W x H: 230 x 160 x 57 mm
- socket L x W: 150 x 40 mm

731103 anthracite, silver coloured brushed  3000 K

600 lm **125,95 €**

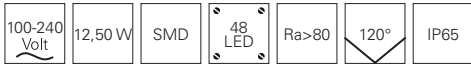

suitable
bollard lights
page 282
733052
733053



CHERTAN

With its unusual material mix of die-cast aluminium housing and a concrete base, the CHERTAN outdoor wall luminaire stands out visually from other models. With its pleasant warm white light and a beam angle of 120° including motion and twilight switch, the outdoor luminaire is perfect for decorative use in entrance areas.



CHERTAN

- aluminium diecast | concrete
- dimensions L x W x H: 170 x 90 x 302 mm
- socket L x W x H: 110 x 22 x 800 mm
- motion / twilight switch

731113 ■ anthracite, concrete  3000 K 570 lm **149,95 €**

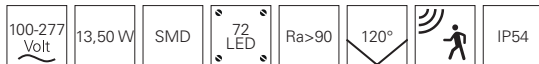

suitable
bollard lights
page 284
733043
733044
733045



MARKAB

Timeless and luminous – the MARKAB is a thoroughly modern wall-mounted luminaire for outdoor use in private and commercial areas. Whether on house walls, boundary walls or in parks – thanks to its sophisticated housing design, the MARKAB emits its powerful 620 lumens to its surroundings with absolutely no glare. With a wide beam angle of 304°, the discreet outdoor luminaire not only illuminates its immediate surroundings. Thanks to the robust diecast aluminium housing and the IP65 certification, you will enjoy the MARKAB for a long time.



MARKAB

- aluminium diecast
- dimensions L x W x H: 248 x 117 x 70 mm
- socket L x W x H: 210 x 45 x 18 mm

731117 ■ dark grey ■ 3000 K 620 lm **84,95 €**





ALCYONE

- aluminium diecast
- dimensions L x W x H: 65 x 28 x 170 mm
- socket L x W x H: 60 x 10 x 140 mm

731101 ■ Graphite grey RAL 7024 ww 3000 K

310 lm **55,95 €**

220-240 Volt	7,80 W	SMD	12 LED	Ra>80	108°		IP54
-----------------	--------	-----	-----------	-------	------	--	------



KIMBALI ECKIG

- aluminium
- dimensions L x W x H: 160 x 90 x 50 mm
- socket L x W: 148 x 85 mm

731014 ■ anthracite ww 3000 K

370 lm **99,95 €**

220-240 Volt	6 W	COB	2 LED	Ra>80	80°		IP44
-----------------	-----	-----	----------	-------	-----	--	------



GRUMIUM

Modular, compact, with great effect – the GRUMIUM surface-mounted wall luminaire can be installed on terraces, on house walls or in the entrance area of living environments and is a flexible universal solution for many areas of application thanks to its optional covers with different designs. The permanently installed and energy-saving LEDs with a maximum of 10 watts are surrounded by a diffuser made of milky plastic and produce a pleasant warm white light with a luminous flux of 730lm. The Grumium outdoor luminaire with its die-cast aluminium housing is available in angular and rounded versions and has an IP54 protection rating.



GRUMIUM ANGULAR CCT I

- aluminium diecast
- dimensions L x W x H: 100 x 70 x 200 mm
- socket B x H x Ø: 95 x 15 x 195 mm

620123	■ dark grey borders	WW NW	3000/4000 K	450 lm	89,95 €
620124	■ dark grey lines diagonal	WW NW	3000/4000 K	205 lm	89,95 €
620125	■ dark grey lines horizontally	WW NW	3000/4000 K	280 lm	89,95 €
620126	■ dark grey lines vertical	WW NW	3000/4000 K	300 lm	89,95 €
620127	■ dark grey upside/below	WW NW	3000/4000 K	440 lm	89,95 €

220-240 Volt	10 W	SMD	64 LED	Ra>80	138°	IP54
-----------------	------	-----	-----------	-------	------	------



GRUMIUM ROUND I

- aluminium diecast
- dimensions L x W x H: 100 x 70 x 200 mm
- socket B x H x Ø: 95 x 15 x 195 mm

620128	■ dark grey upside/below	WW	3000 K	325 lm	89,95 €
620129	■ dark grey waist	WW	3000 K	210 lm	89,95 €
620130	■ dark grey lines horizontally	WW	3000 K	250 lm	89,95 €

100-240 Volt	10 W	SMD	32 LED	Ra80	180°	IP54
-----------------	------	-----	-----------	------	------	------



GIANFAR

The elegant GIANFAR outdoor wall light convinces with a classic and expressive design. Practical: The sticker set included in the scope of delivery allows you to quickly and easily transform the GIANFAR into a house number light if required.

GIANFAR

- aluminium diecast
- dimensions L x W x H: 161 x 59 x 211 mm
- socket L x W x H: 145 x 17 x 73 mm

731119 ■ Traffic grey RAL 7043 ww 3000 K 930 lm **106,95 €**

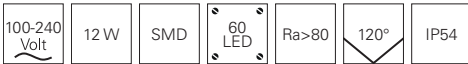

accessories

948139 numbers set | numbers each 3x [0 to 9] and letters each 1x [A to J] **8,95 €**



PICTORIS

- aluminium diecast
- dimensions L x W x H: 160 x 50 x 210 mm
- socket L x W x H: 155 x 15 x 205 mm

731091 ■ dark grey ww 3000 K 510 lm **54,95 €**

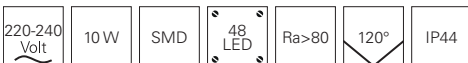

accessories

948139 numbers set | numbers each 3x [0 to 9] and letters each 1x [A to J] **8,95 €**





VOLANTIS

- aluminium diecast
- dimensions L x W x H: 300 x 300 x 47 mm
- socket L x W x H: 165 x 165 x 25 mm

731109  dark grey  3000 K 1300 lm **189,95 €**

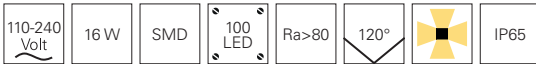

LYNCIS

The LYNCS LED wall-mounted luminaire not only impresses with its sophisticated and filigree design [winner of the Red Dot Design Award 2017], but also with its outdoor properties. The compact IP65-certified outdoor luminaire sits in a dark grey die-cast aluminium housing and with its 96 LEDs produces a 10-watt, warm white light [500 lm] that integrates seamlessly into a wide range of outdoor applications.

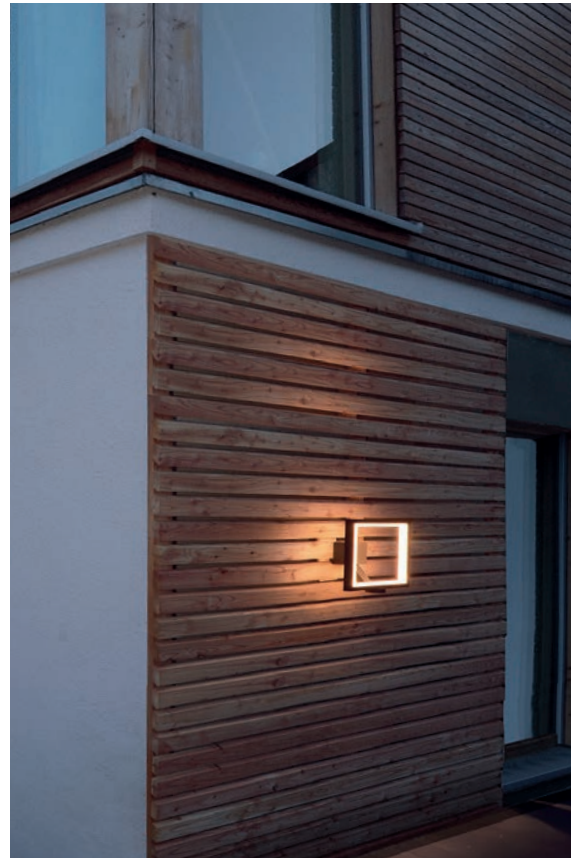

reddot award 2017
winner



LYNCIS

- aluminium diecast
- dimensions L x W x H: 300 x 142 x 315 mm
- socket L x W x H: 95 x 95 x 18 mm







731102 ■ dark grey ■ ww 3000 K 500 lm **125,95 €**

220-240 Volt	10 W	SMD	96 LED	Ra>80	170°	IP65
-----------------	------	-----	-----------	-------	------	------



CUBODO A

- aluminium diecast
- dimensions L x W x H: 90 x 110 x 90 mm
- socket L x W x H: 59 x 59 x 20 mm

730380		white		3000 K	270 lm	106,95 €
730329		brown		3000 K	270 lm	106,95 €
730328		anthracite		3000 K	270 lm	106,95 €

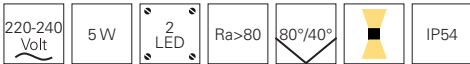



CUBODO II SINGLE DG MINI

- aluminium diecast
- dimensions L x W x H: 90 x 68 x 70 mm
- socket L x W x H: 65 x 65 x 20 mm

731029 ■ dark grey  3000 K 220 lm **99,95 €**



CUBODO II DOUBLE DG MINI

- aluminium diecast
- dimensions L x W x H: 90 x 68 x 108 mm
- socket L x W x H: 65 x 65 x 20 mm



731030 ■ dark grey  3000 K 440 lm **129,95 €**





CUBODO II SINGLE



- aluminium diecast
- dimensions L x W x H: 108 x 108 x 115 mm
- socket L x W: 108 x 108 mm

731026	<input type="checkbox"/>	white		3000 K	600 lm	135,95 €
731025	<input type="checkbox"/>	silver coloured		3000 K	600 lm	135,95 €
731024	<input type="checkbox"/>	dark grey		3000 K	600 lm	135,95 €



CUBODO II DOUBLE

- aluminium diecast
- dimensions L x W x H: 108 x 108 x 115 mm
- socket L x W: 108 x 108 mm

731020	<input type="checkbox"/>	white		3000 K	1260 lm	149,95 €
731019	<input type="checkbox"/>	silver coloured		3000 K	1260 lm	149,95 €
731015	<input type="checkbox"/>	dark grey		3000 K	1260 lm	149,95 €





ARCTURUS

The ARCTURUS LED wall-mounted luminaire presents itself in a modern cube design [also available in an elongated form] and is suitable for flexible lighting in outdoor areas. The beam angle of the IP54 luminaire can be adjusted between 0° and 90° via an integrated shutter to generate a different light pattern depending on the application requirements. Protected in the dark grey die-cast aluminium housing are the two high-power LEDs that produce a warm white, 5.5 W light.



ARCTURUS I

- aluminium diecast
- dimensions L x W x H: 79 x 110 x 172 mm
- socket L x W x H: 68 x 110 x 110 mm

731099 ■ Graphite grey RAL 7024  3000 K 200 lm **95,95 €**

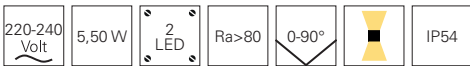

ARCTURUS II

- aluminium diecast
- dimensions L x W x H: 140 x 105 x 145 mm
- socket L x W x H: 75 x 100 x 120 mm

731100 ■ Graphite grey RAL 7024  3000 K 200 lm **95,95 €**

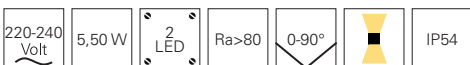





ANCHA I

- aluminium diecast
- dimensions L x W x H: 80 x 92 x 97 mm
- socket L x W x H: 74 x 12 x 83 mm

731087 ■ Graphite grey RAL 7024  3000 K 260 lm **72,95 €**

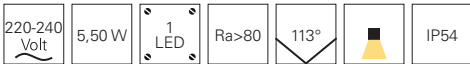

ANCHA II

- aluminium diecast
- dimensions L x W x H: 80 x 92 x 105 mm
- socket L x W x H: 74 x 12 x 83 mm

731088 ■ Graphite grey RAL 7024  3000 K 530 lm **96,95 €**

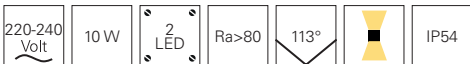

CUBE

- aluminium diecast
- dimensions L x W x H: 70 x 120 x 60 mm
- socket L x W: 70 x 60 mm

730355 ■ anthracite  2700 K 400 lm **119,95 €**





LINEAR I SINGLE

- aluminium diecast
- dimensions T x H: 60 x 60 mm
- socket L x W x H: 493 x 53 x 15 mm

731135	■ dark grey B: 250 mm	ww 3000 K	600 lm	8,5 W	129,95 €
731134	■ dark grey B: 500 mm	ww 3000 K	1230 lm	14,0 W	169,95 €

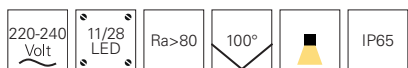

LINEAR II DOUBLE

- aluminium diecast
- dimensions T x H: 60 x 60 mm
- socket L x W x H: 242 x 53 x 15 mm

731136	■ dark grey B: 250 mm	ww 3000 K	1155 lm	14,0 W	159,95 €
731129	■ dark grey B: 500 mm	ww 3000 K	1760 lm	20,0 W	189,95 €

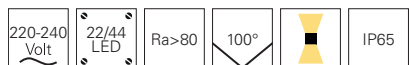



JABBAH

The square JABBAH uses integrated COB LEDs in warm white and emits its light asymmetrically at 75° in a cone shape onto walls - in the simple version with 915 lumens, as UP AND DOWN version with a total of 1850 lumens. In addition, the double-sided JABBAH can be dimmed to 60% light output via a dip switch if a more discreet light output is desired.



JABBAH

- modern design
- dimmable to 60% via DIP switch
- high luminous intensity
- aluminium diecast
- dimensions L x W x H: 150 x 150 x 150 mm

731128 ■ dark grey ■ ww 3000 K 915 lm **199,95 €**

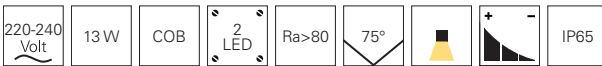

JABBAH UP AND DOWN

- modern design
- dimmable to 60% via DIP switch
- high luminous intensity
- aluminium diecast
- dimensions L x W x H: 150 x 150 x 150 mm

731127 ■ dark grey ■ ww 3000 K 1850 lm **259,95 €**

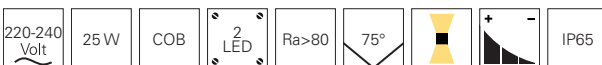



AGUDO II SINGLE

- aluminium diecast
- dimensions L x W x H: 63 x 80 x 75 mm
- socket L x W: 75 x 75 mm

730381 ■ anthracite ww 3000 K 70 lm **59,95 €**

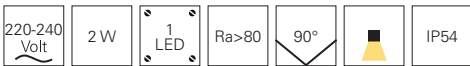

AGUDO II DOUBLE

- aluminium diecast
- dimensions L x W x H: 140 x 80 x 65 mm
- socket L x W: 140 x 75 mm

730382 ■ anthracite ww 3000 K 140 lm **79,95 €**

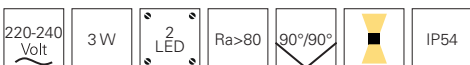





ALKES

The ALKES series is not a classic wall-mounted luminaire, but with its SMD LED panel is reminiscent of a floodlight. The highlight: the upper part of the housing is tilted forward by 45° from the façade to direct the warm white light specifically onto the surface to be illuminated. In addition, the ALKES with its modern design and rounded edges cuts a great figure even when switched off.



ALKES

- modern design
- sophisticated effect lighting
- can also be used indoors
- aluminium diecast

731138	■ dark grey	ww 3000 K	920 lm	L x W x H: 200 x 126 x 184 mm	21W	95,95 €
731140	■ dark grey	ww 3000 K	1720 lm	L x W x H: 297 x 165 x 240 mm	36W	149,95 €

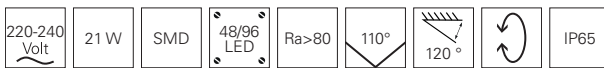

ALKES MOTION

- modern design
- sophisticated effect lighting
- can also be used indoors
- aluminium diecast
- motion sensor

731139	■ dark grey	ww 3000 K	735 lm	L x W x H: 200 x 126 x 184 mm	21W	119,95 €
731141	■ dark grey	ww 3000 K	1720 lm	L x W x H: 297 x 165 x 240 mm	36W	179,95 €

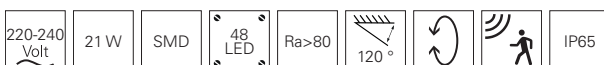



suitable
bollard light
page 292
733031

TUCANAE

- aluminium diecast
- dimensions L x W x H: 140 x 172 x 219 mm
- socket L x W x H: 125 x 135 x 15 mm

731110 ■ dark grey ■ 3000 K 1650 lm **135,95 €**



suitable
bollard light
page 292
733036

TUCANAE MOTION

- aluminium diecast
- dimensions L x W x H: 140 x 172 x 219 mm
- socket L x W x H: 125 x 135 x 15 mm
- motion / twilight switch

731115 ■ dark grey ■ 3000 K 1650 lm **155,95 €**





reddot award 2017
winner



ROBI FLEX

- aluminium diecast
- dimensions L x W x H: 120 x 45 x 125 mm
- socket L x W: 78 x 45 mm

731068 dark grey 3000 K 700 lm **159,95 €**

--	--	--	--	--	--	--	--	--

suitable
bollard light
page 290
733007





GRUIS I

- aluminium diecast
- dimensions L x W x H: 224 x 80 x 220 mm
- socket L x W x H: 88 x 70 x 12 mm

731054 ■ anthracite ww 3000 K 310 lm **69,95 €**

220-240 Volt	8,40 W	SMD	12 LED	Ra>80	106°	IP54
-----------------	--------	-----	-----------	-------	------	------



GRUIS II

- aluminium diecast
- dimensions L x W x H: 250 x 80 x 200 mm
- socket L x W x H: 88 x 70 x 12 mm

731055 ■ anthracite ww 3000 K 310 lm **69,95 €**

220-240 Volt	8,40 W	SMD	12 LED	Ra>80	106°	IP54
-----------------	--------	-----	-----------	-------	------	------



suitable
bollard light
page 289
733005



IRETTA

- aluminium diecast
- dimensions L x W x H: 150 x 125 x 97,5 mm
- socket L x W: 121 x 93 mm
- motion / twilight switch

730395 ■ anthracite

ww 3000 K

370 lm **135,95 €**

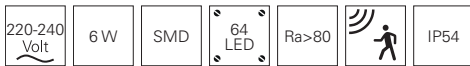

suitable
bollard light
page 290
730354



BEACON MOTION

- aluminium diecast
- dimensions L x W x H: 250 x 68 x 106 mm
- socket L x W x H: 68 x 68 x 5 mm
- motion / twilight switch

731016 ■ Traffic grey B RAL 7043

ww 3000 K

290 lm **109,95 €**



suitable
bollard lights
page 289
733006
733008



ORTIS

- aluminium diecast
- dimensions L x W x H x Ø: 260 x 120 x 181 x 120 mm
- socket L x W x H: 100 x 77 x 67 mm

731031 ■ dark grey ■ **ww** 3000 K 510 lm **159,95 €**

220-240 Volt	15 W	COB	1 LED	Ra>80	360°	IP54
-----------------	------	-----	----------	-------	------	------

suitable
bollard light
page 288
733004





BESSMA IV

- aluminium diecast
- dimensions L x W x H: 90 x 93,1 x 251,8 mm
- socket L x W x H: 90 x 12 x 44 mm

731083 ■ Traffic grey RAL 7043 ww 3000 K

580 lm **52,95 €**

100-240 Volt	9 W	SMD	8 LED	Ra>80	360°	IP54
-----------------	-----	-----	----------	-------	------	------

suitable
bollard lights
page 288
733025
733026



TRILA

- aluminium diecast
- dimensions L x W x H: 128,4 x 158,7 x 200 mm
- socket L x W x H: 80 x 80 x 50 mm

730366 ■ Traffic grey RAL 7043 ww 3000 K

361 lm **104,95 €**

220-240 Volt	6 W	SMD	90 LED	Ra>80	IP44
-----------------	-----	-----	-----------	-------	------

suitable
bollard lights
page 287
730364
730365

MOBBY II

- aluminium diecast
- dimensions H x Ø: 100 x 84 mm
- socket H x Ø: 34 x 95 mm
- dimmable via leading or trailing edge

731021 ■ Black grey RAL 7021  3000 K 810 lm **149,95 €**

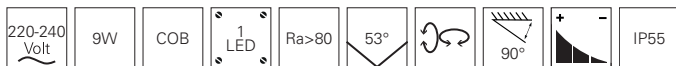

accessories

930194 reflector 33°

12,95 €



MOBBY II DOUBLE

- aluminium diecast
- dimensions L x W x H x Ø: 84 x 124 x 220 x 84 mm
- socket L x W x H: 120 x 80 x 34 mm

731071 ■ Black grey RAL 7021  3000 K 1620 lm **269,95 €**



accessories

930194 reflector 33°

12,95 €





MOBBY II SINGLE

- aluminium diecast
- dimensions L x W x H x Ø: 84 x 124 x 120 x 84 mm
- socket L x W x H: 120 x 80 x 34 mm

731072 ■ Black grey RAL 7021 ww 3000 K 810 lm **159,95 €**

220-240 Volt	9W	COB	1 LED	Ra>80	53°	IP55
-----------------	----	-----	----------	-------	-----	------

accessories

930194 reflector 33°

12,95 €



With the kind support of Lettisches Haus in Freiburg / info@lettischeshaus.de



TYL

- aluminium diecast
- dimensions L x W x H: 236 x 68 x 75 mm
- socket L x W x H: 135 x 20 x 50 mm

731080 ■ Traffic grey B RAL 7043  3000 K

530 lm **63,95 €**



BEID

- aluminium diecast
- dimensions L x W x H: 200 x 111,7 x 66,6 mm
- socket L x W x H: 145 x 18 x 48 mm

731082 ■ Traffic grey B RAL 7043  3000 K

360 lm **63,95 €**



ALBALDAH MOTION

- timeless design
- sophisticated effect lighting
- can also be used indoors
- aluminium diecast
- dimensions L x H: 220 x 120 mm
- motion sensor

731132  grey  3000 K 645 lm **95,95 €**



LACERTAE

LACERTAE is a light catcher - and guaranteed to catch the eye at any garden party. With its powerful rechargeable battery that can be charged via USB, the table luminaire provides a romantic ambience in three dimmer settings. Matching the portable version, the LACERTAE also convinces as a rustic wall light including motion detector on brick and natural stone walls.



LACERTAE

- aluminium diecast | Glas
- dimensions L x W x H: 180 x 256 x 370 mm
- socket L x W x H: 98 x 30 x 105 mm
- motion sensor

731112 ■ dark grey ■ **ww** 3000 K 440 lm **149,95 €**

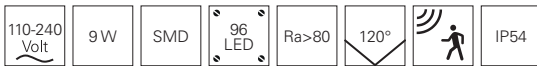

suitable
battery
table light
page 260
346009





TANIA

- aluminium diecast
- dimensions L x W x H: 230 x 33 x 80 mm
- socket L x W x H: 220 x 70 x 25 mm
- with indirect light cone

731079 ■ Traffic grey B RAL 7043 ww 3000 K 690 lm **59,95 €**

220-240 Volt	9 W	SMD	45 LED	Ra>80	360°	IP54
-----------------	-----	-----	-----------	-------	------	------



With the kind support of Licht von Klein / www.licht-von-klein.de



URIA 6

- aluminium diecast
- dimensions L x W x H: 220 x 77 x 90 mm
- socket L x W x H: 190 x 20 x 75 mm

731032 ■ Slate grey RAL 7015  3000 K

296 lm **74,95 €**

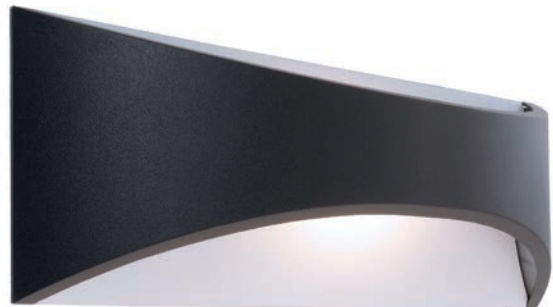

URIA 10

- aluminium diecast
- dimensions L x W x H: 300 x 97 x 120 mm
- socket L x W x H: 270 x 20 x 85 mm

731033 ■ Slate grey RAL 7015  3000 K

408 lm **95,95 €**



SEGIN

The SEGIN LED wall-mounted luminaire is suitable for versatile outdoor use and illuminates outdoor and entrance areas of buildings and can also be used as a house number luminaire if required. In addition to the robust die-cast aluminium housing, the SEGIN also has a round shutter that allows the direction of light to be flexibly adjusted to the respective application.



SEGIN

- aluminium diecast
- dimensions L x W x H x Ø: 223 x 130 x 105 x 105 mm
- socket L x W x H: 185 x 63 x 30 mm

731118 ■ Traffic grey B RAL 7043 ww 3000 K 370 lm **115,95 €**



BERMUDA

Admittedly, a big name for a small luminaire. But in its design, the BERMUDA series is undoubtedly just as exciting as the well-known triangle. The small light dwarf is an enrichment for every garden and fits like a small mushroom into every outdoor environment. And by the way, it also cuts a fine figure as a wall luminaire.



suitable
bollard light
page 294
733056



suitable
ground spike
lights
IP65
page 392
733060
733059



suitable
wall lights
page 162
342159
342160



BERMUDA

- Design by Johannes Tomm
- eye-catching outdoor lighting
- 360° beam angle
- aluminium diecast
- dimensions H x Ø: 142 x 200 mm
- socket H x Ø: 79 x 70 mm
- dimmable via leading or trailing edge

731124 ■ Black grey RAL 7021  3000 K

600 lm **119,95 €**



suitable
table /
floor lights
page 212
346018
346017
343029
343028





□ ■
page 360



□ ■
page 361



□ ■
page 361



□
page 362



□
page 362



□ ■
page 363



■
page 364



■ □
page 365



■
page 366



■
page 366



ceiling and wall lights





MOB ROUND I

- aluminium diecast
- dimensions H x Ø: 92 x 108 mm
- socket Ø: 100 mm
- dimmable via optional illuminants

730407 white **63,95 €**
730408 anthracite **63,95 €**



suitable illuminants on page 978





MOB SQUARE II

- aluminium diecast
- dimensions L x W x H: 108 x 108 x 100 mm
- socket L x W: 108 x 108 mm
- dimmable via optional illuminants

730409 white **74,95 €**

730410 anthracite **74,95 €**



suitable illuminants on page 978



CETI

- aluminium diecast
- dimensions L x W x H: 85 x 85 x 99 mm
- socket L x W: 85 x 85 mm
- dimmable via leading or trailing edge

348045 white matt  3000 K 730 lm **163,95 €**

348046 black  3000 K 730 lm **163,95 €**





SCUTI I

- stainless steel
- dimensions L x W x H: 285 x 285 x 85 mm
- dimmable via optional illuminants

731052  silver coloured brushed **54,95 €**



suitable illuminants on page 974-977



SCUTI II

- stainless steel
- dimensions H x Ø: 85 x 285 mm
- dimmable via optional illuminants

731053  silver coloured brushed **54,95 €**



suitable illuminants on page 974-977



AURIGAE

- aluminium diecast
- dimensions L x W x H: 250 x 250 x 60 mm
- socket L x W x H: 190 x 190 x 20 mm

348121	<input type="checkbox"/>	white	<input type="checkbox"/>	3000 K	1550 lm	105,95 €
348120	<input checked="" type="checkbox"/>	Traffic grey B RAL 7043	<input type="checkbox"/>	3000 K	1550 lm	105,95 €

220-240 Volt	20 W	SMD	172 LED	Ra>80	110°	IP65
-----------------	------	-----	------------	-------	------	------



ASCELLA

- aluminium diecast
- dimensions H x Ø: 50 x 340 mm
- socket H x Ø: 12 x 270 mm

348069 ■ Graphite grey RAL 7024 ww 3000 K 2300 lm **179,95 €**



ARNEB

- aluminium diecast
- dimensions L x W x H: 340 x 340 x 50 mm
- socket H x Ø: 12 x 270 mm

348070 ■ dark grey ww 3000 K 2300 lm **179,95 €**





QUADRATA I

- plastic
- dimensions L x W x H: 220 x 220 x 56 mm
- socket L x W x H: 190 x 190 x 10 mm

348011  Platinum grey RAL 7036  3000 K 680 lm **95,95 €**

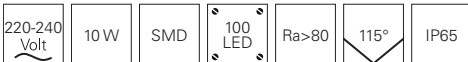

QUADRATA II

- plastic
- dimensions L x W x H: 296 x 296 x 78 mm
- socket L x W x H: 230 x 230 x 10 mm

348009  Platinum grey RAL 7036  3000 K 1110 lm **109,95 €**

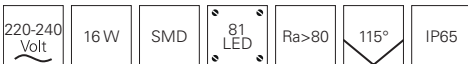

QUADRATA III

- plastic
- dimensions L x W x H: 400 x 400 x 93 mm
- socket L x W x H: 312 x 312 x 10 mm

348007  Platinum grey RAL 7036  3000 K 1280 lm **152,95 €**





MENSAE ROUND

- motion / twilight switch
- aluminium diecast
- dimensions H x Ø: 48 x 300 mm
- socket H x Ø: 28 x 170 mm

348072 ■ dark grey  3000 K 1340 lm **205,95 €**



MENSAE ANGULAR

- motion / twilight switch
- aluminium diecast
- dimensions L x W x H: 300 x 300 x 48 mm
- socket H x Ø: 28 x 170 mm

348071 ■ dark grey  3000 K 1240 lm **205,95 €**







□
page 370



□
page 370



□ ■
page 372



□ ■
page 372



□ ■
page 372



□ □ ■
page 375



□ □ ■
page 375



□ □ ■
page 375



□ □ ■
page 375



□ ■ ■
page 377



□ ■ ■
page 377



□ ■ ■
page 377



□ ■ ■
page 377



built in wall lights





SIDE II WW

- aluminium diecast
- dimensions L x W x H: 171 x 106 x 65 mm
- dimmable via optional illuminants

100028  silver coloured mat **53,95 €**





passende Leuchtmittel auf page 978



SIDE III LED RGB

- aluminium diecast
- dimensions L x W x H: 171 x 106 x 65 mm
- dimmbar über optionalen Controller

100238  silver coloured mat  24 lm **96,95 €**



suitable controllers and dimmers from page 940
 suitable power supplies from page 896

With the kind support of Loxone Lichtinstallation Eurotec-lbiza@fotoeichhorn





YVETTE I

- aluminium diecast
- dimensions L x W x H: 107 x 75 x 64,5 mm

763005	<input type="checkbox"/> white	<input checked="" type="checkbox"/> 3000 K	108 lm	63,95 €
763004	<input checked="" type="checkbox"/> anthracite	<input checked="" type="checkbox"/> 3000 K	75 lm	63,95 €

220-240 Volt	3,60 W	SMD	12 LED	Ra>80	22°	105x72	57	IP65
--------------	--------	-----	--------	-------	-----	--------	----	------



YVETTE II

- aluminium diecast
- dimensions L x W x H: 75 x 105 x 64,5 mm

763007	<input type="checkbox"/> white	<input checked="" type="checkbox"/> 3000 K	130 lm	63,95 €
763006	<input checked="" type="checkbox"/> anthracite	<input checked="" type="checkbox"/> 3000 K	100 lm	63,95 €

220-240 Volt	3,60 W	SMD	12 LED	Ra>80	54°	105x72	57	IP65
--------------	--------	-----	--------	-------	-----	--------	----	------

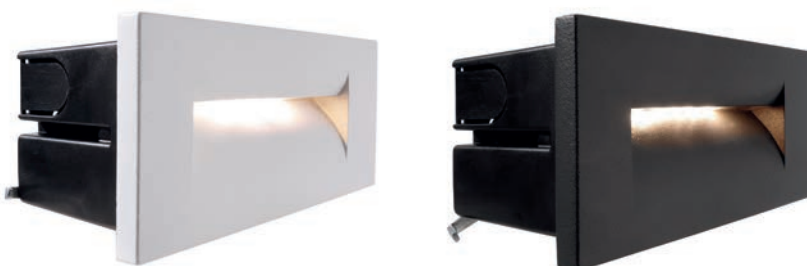

YVETTE III

- aluminium diecast
- dimensions L x W x H: 250 x 87 x 73 mm

763012	<input type="checkbox"/> white	<input checked="" type="checkbox"/> 3000 K	335 lm	127,95 €
763011	<input checked="" type="checkbox"/> anthracite	<input checked="" type="checkbox"/> 3000 K	219 lm	127,95 €

220-240 Volt	8,40 W	SMD	40 LED	Ra>80	42°	243x75	65	IP65
--------------	--------	-----	--------	-------	-----	--------	----	------





LIGHT BASE II COB OUTDOOR

- aluminium diecast
- dimensions L x H x B x H: 96 x 96 x 77 mm
- excl. wall-mounted socket
- excl. cover

763025  grey  3000 K 55 lm **85,95 €**

220-240 Volt	1 W	COB	1 LED	Ra>80	36°	95x95	70	IP67
-----------------	-----	-----	----------	-------	-----	-------	----	------



With the kind support of Loxone Lichtinstallation Eurotec-Ibiza@fotoeichhorn



accessories

930416	<input type="checkbox"/> cover angular step white	100 x 100 x 24 mm	15,95 €
930417	<input type="checkbox"/> cover angular step silver grey	100 x 100 x 24 mm	15,95 €
930418	<input type="checkbox"/> cover angular step black	100 x 100 x 24 mm	15,95 €
930419	<input type="checkbox"/> cover angular stripe white	100 x 100 x 24 mm	15,95 €
930414	<input type="checkbox"/> cover angular stripe silver grey	100 x 100 x 24 mm	15,95 €
930420	<input type="checkbox"/> cover angular stripe black	100 x 100 x 24 mm	15,95 €
930421	<input type="checkbox"/> cover angular linear white	100 x 100 x 24 mm	15,95 €
930422	<input type="checkbox"/> cover angular linear silver grey	100 x 100 x 24 mm	15,95 €
930415	<input type="checkbox"/> cover angular linear black	100 x 100 x 24 mm	15,95 €
930413	<input type="checkbox"/> cover angular round white	100 x 100 x 24 mm	15,95 €
930423	<input type="checkbox"/> cover angular round silver grey	100 x 100 x 24 mm	15,95 €
930424	<input type="checkbox"/> cover angular round black	100 x 100 x 24 mm	15,95 €



LIGHT BASE III OUTDOOR

- aluminium diecast
- dimensions L x H x B x H: 245 x 85 x 78 mm
- excl. wall-mounted socket
- excl. cover

763026 ■ black ww 3000 K 88 lm **129,95 €**

220-240 Volt	4 W	SMD	1 LED	Ra>90	115°	245x85	78	IP65
-----------------	-----	-----	----------	-------	------	--------	----	------



With the kind support of Loxone Lichtinstallation Eurotec-Ibiza@fotoeichhorn

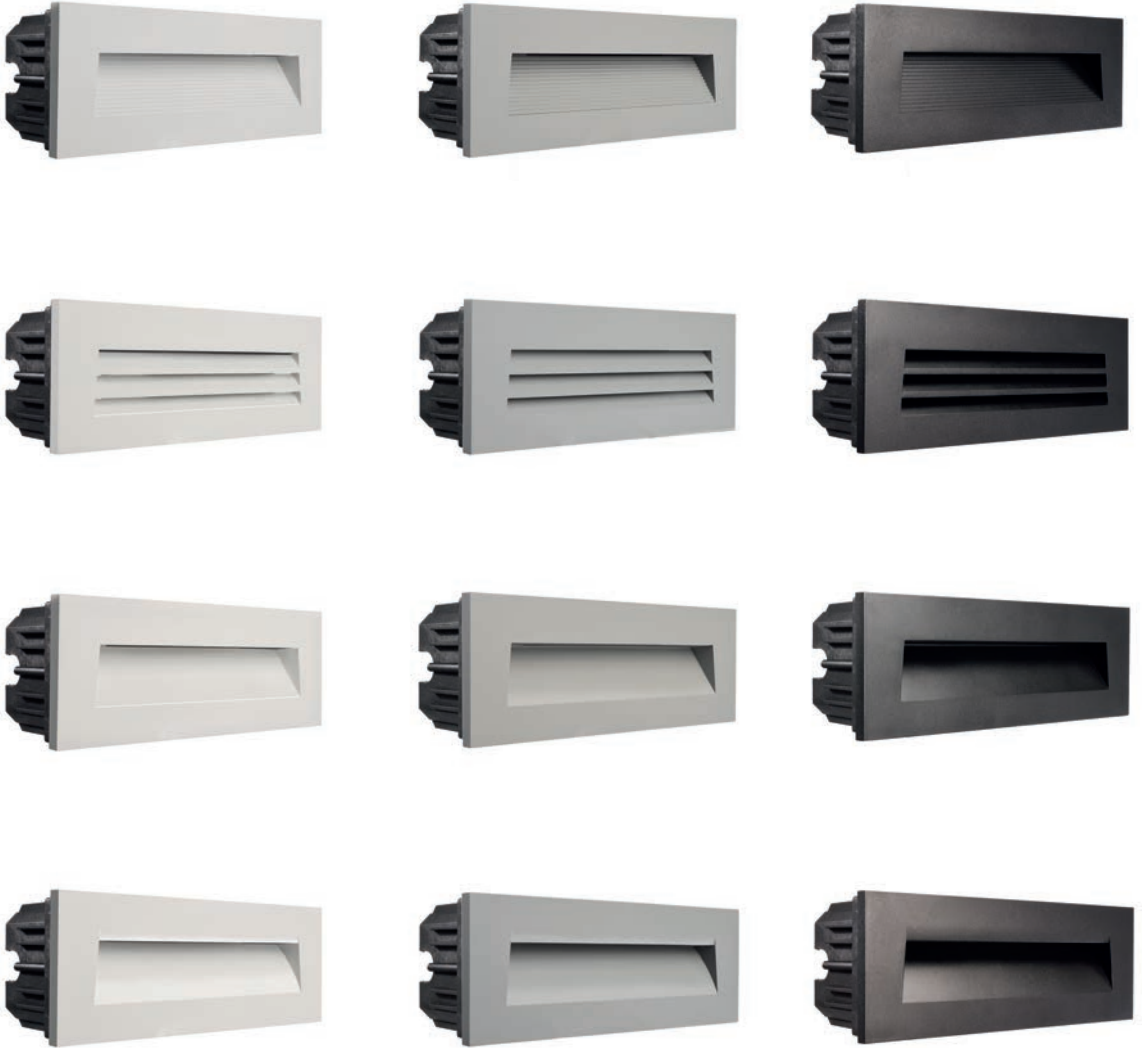

Abdeckungen

930461	 cover step white	250 x 90 x 24 mm	57,95 €
930468	 cover step grey	250 x 90 x 24 mm	57,95 €
930469	 cover step black	250 x 90 x 24 mm	57,95 €
930470	 cover stripe white	250 x 90 x 24 mm	57,95 €
930471	 cover stripe grey	250 x 90 x 24 mm	57,95 €
930472	 cover stripe black	250 x 90 x 24 mm	57,95 €
930473	 cover angled white	250 x 90 x 24 mm	57,95 €
930474	 cover angled grey	250 x 90 x 24 mm	57,95 €
930475	 cover angled black	250 x 90 x 24 mm	57,95 €
930476	 cover round white	250 x 90 x 24 mm	57,95 €
930477	 cover round grey	250 x 90 x 24 mm	57,95 €
930478	 cover round black	250 x 90 x 24 mm	57,95 €



□ □
page 380



■ □
page 380



■ □
page 381



■ □
page 382



■
page 383



■
page 384



■
page 384



■
page 385



spherical and floor lamps



SPHERICAL LAMP

- polyethylene [LLDPE]
- dimmable via optional illuminants
- ready to plug in with IP44 safety plug
- incl. ground spike

836011	<input type="checkbox"/>	white Ø: 300 mm	max. 20 W	69,95 €
836930	<input type="checkbox"/>	white Ø: 400 mm	max. 42 W	89,95 €
836014	<input type="checkbox"/>	white Ø: 500 mm	max. 42 W	109,95 €
836931	<input type="checkbox"/>	white Ø: 600 mm	max. 42 W	169,95 €
836958	<input type="checkbox"/>	white Ø: 800 mm	max. 42 W	299,95 €



suitable illuminants on page 974-977

suitable energy distributors/plug-in socket towers on page 388



SPHERICAL LAMP GRANIT

- polyresin
- dimmable via optional illuminants
- ready to plug in with IP44 safety plug
- incl. ground spike

836012	<input checked="" type="checkbox"/>	Granite optics Ø: 300 mm	max. 20 W	69,95 €
836934	<input checked="" type="checkbox"/>	Granite optics Ø: 400 mm	max. 42 W	89,95 €
836015	<input checked="" type="checkbox"/>	Granite optics Ø: 500 mm	max. 42 W	109,95 €
836935	<input checked="" type="checkbox"/>	Granite optics Ø: 600 mm	max. 42 W	169,95 €
836960	<input checked="" type="checkbox"/>	Granite optics Ø: 800 mm	max. 42 W	299,95 €



suitable illuminants on page 974-977

suitable energy distributors/plug-in socket towers on page 388



SPHERICAL LAMP TERRACOTTA

- polyresin
- dimmable via optional illuminants
- ready to plug in with IP44 safety plug
- incl. ground spike

836013		Terracotta Ø: 300 mm	max. 20 W	69,95 €
836961		Terracotta Ø: 400 mm	max. 42 W	89,95 €
836016		Terracotta Ø: 500 mm	max. 42 W	109,95 €
836962		Terracotta Ø: 600 mm	max. 42 W	169,95 €
836963		Terracotta Ø: 800 mm	max. 42 W	299,95 €



suitable illuminants on page 974-977

suitable energy distributors/plug-in socket towers on page 388



BOOTIS I

- aluminium diecast
- dimensions L x W x H: 150 x 150 x 161 mm
- socket L x W x H: 140 x 140 x 20 mm

733032 ■ Traffic grey B RAL 7043  3000 K 700 lm **87,95 €**

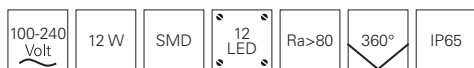

BOOTIS II

- aluminium diecast
- dimensions L x W x H: 250 x 250 x 270 mm
- socket L x W x H: 240 x 240 x 35 mm
- dimmable via leading or trailing edge

733027 ■ Traffic grey B RAL 7043  3000 K 1100 lm **133,95 €**

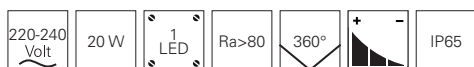



ALEXA I

- aluminium diecast
- dimensions L x W x H x Ø: 300 x 350 x 1500 x 350 mm
- socket Ø: 480 mm
- ready to plug in with IP44 safety plug
- dimmable via optional illuminants

733017 ■ Anthracite grey RAL 7016 painted

249,95 €



suitable illuminants on page 974-977
 suitable energy distributors/plug-in socket towers on page 388



VELORUM

Flexible outdoor luminaires, ready to plug in for any application, that is what the VELORUM series is all about. With its three versions - floor, table and pendant luminaire – it brings a living room atmosphere into your garden. Due to its robust design, it can withstand a lot and is thus the ideal party lighting.

VELORUM

- plastic
- dimensions H x Ø: 510 x 224 mm
- socket H x Ø: 8 x 230 mm
- incl. 3 m connection cable with IP44 plug

836019 ■ Anthracite grey RAL 7016 **109,95 €**



suitable illuminants on page 974-977

suitable energy distributors/plug-in socket towers on page 388



VELORUM

- plastic
- dimensions H x Ø: 1450 x 345 mm
- socket H x Ø: 10 x 300 mm
- incl. 3 m connection cable with IP44 plug

836018 ■ Anthracite grey RAL 7016 **163,95 €**



suitable illuminants on page 974-977

suitable energy distributors/plug-in socket towers on page 388





VELORUM

- plastic
- dimensions H x Ø: 254 x 290 mm
- max. Abhängung: 1,00 m
- incl. 2,5 m connection cable with IP44 plug

836020 ■ Anthracite grey RAL 7016

99,95 €



suitable illuminants on page 974-977





■
page 388



■
page 388



energy distributor



SOCKET TOWER

Sometimes it takes a little more than simply »just« light. With our socket tower, available with and without light, we are closing another gap in our range. Make your garden even more flexible – of course in proven DEKO-LIGHT quality at a fair price.



SOCKET TOWER

- aluminium diecast
- dimensions L x H x Ø: 400 x 100 mm
- incl. 2 outlets [total load max. 3650 W]

733055 ■ dark grey

109,95 €



SOCKET TOWER ILLUMINATED

- aluminium diecast
- dimensions L x H x Ø: 478 x 100 mm
- light switchable
- incl. 2 outlets [total load max. 3650 W]

733054 ■ dark grey ■ 3000 K 150 lm **159,95 €**







■ ■
page 392



■
page 393



■
page 394



■
page 394



■
page 395



■ ■
page 395



■ ■
page 396



■ ■
page 397



■
page 399



■
page 400



■
page 400



■
page 401



■
page 401



■
page 402



■
page 402



■
page 403



■
page 403



■
page 404



■
page 406



■
page 406



■
page 408



■
page 408



■
page 409



■
page 409



surface-mounted / ground spike lights



BERMUDA

Admittedly, a big name for a small luminaire. But in its design, the BERMUDA series is undoubtedly just as exciting as the well-known triangle. The small light dwarf as an enrichment for every garden and fits like a small mushroom into every outdoor environment. And by the way, it also cuts a fine figure as a wall luminaire.



BERMUDA

- Design by Johannes Tomm
- eye-catching outdoor lighting
- easy mounting
- 360° beam angle
- aluminium diecast
- dimensions H x Ø: 563 x 200 mm
- dimmable via leading or trailing edge
- ready to plug in with IP44 safety plug

733060 white 3000 K 710 lm **175,95 €**
733059 Black grey RAL 7021 3000 K 710 lm **175,95 €**

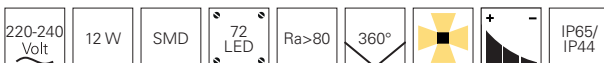

suitable energy distributors/socket towers on page 388



suitable
wall light
IP65
page 356
731124



suitable
bollard light
IP65
page 294
733056



suitable
wall lights
page 162
342159
342160



suitable
table /
floor lights
page 212
346018
346017
343029
343028



LOMI

- aluminium
- dimensions L x Ø: 65 x 100 mm
- dimmable via optional illuminants
- incl. 2 m connection cable with IP44 plug
- incl. ground spike

732126 ■ black mat

42,95 €

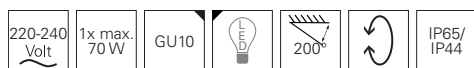

suitable illuminants on page 969-970

suitable energy distributors/socket towers on page 388

MINI I WW

- aluminium diecast
- dimensions W x H x Ø: 85 x 85 x 42 mm
- socket Ø: 66 mm
- dimmable via optional controller
- incl. 2 m connection cable with WEIPU plug

131005  silver coloured  3000 K 150 lm **99,95 €**



accessories

872041 power supply | 24V | 12,0 W | IP65 **20,95 €**

suitable Weipu cables/connectors on page 995-997
suitable controllers and dimmers from page 940
additional power supplies from page 896



MINI I WW

- aluminium diecast
- dimensions W x H x Ø: 85 x 85 x 42 mm
- socket H x Ø: 10 x 66 mm
- dimmable via optional controller
- incl. 2 m connection cable with WEIPU plug

732036  black  3000 K 150 lm **99,95 €**



accessories

872041 power supply | 24V | 12,0 W | IP65 **20,95 €**

suitable Weipu cables/connectors on page 995-997
suitable controllers and dimmers from page 940
additional power supplies from page 896



MINI II CW

- aluminium diecast
- dimensions W x H x Ø: 85 x 85 x 42 mm
- socket Ø: 66 mm
- incl. 2 m connection cable with IP44 safety plug

131006  silver coloured  6000 K 180 lm

119,95 €

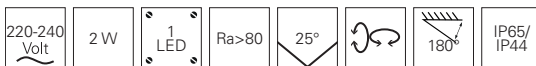

suitable energy distributors/socket towers on page 388
suitable outdoor mounting material ab page 1003



MINI I AMBER

- aluminium diecast
- dimensions W x H x Ø: 85 x 85 x 42 mm
- socket Ø: 66 mm
- dimmable via optional controller
- incl. 2 m connection cable with WEIPU plug

732037  silver coloured  1750 K 57 lm

99,95 €

730238  black  1700 K 65 lm

99,95 €

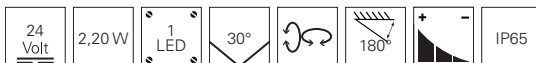

accessories

872041 power supply | 24V | 12,0 W | IP65

20,95 €

suitable Weipu cables/connectors on page 995-997
suitable controllers and dimmers from page 940
additional power supplies from page 896





KEID

- aluminium diecast
- dimensions L x H x Ø: 120 x 211 x 75 mm
- socket H x Ø: 37 x 99 mm

731098 ■ dark grey  3000 K 800 lm **132,95 €**

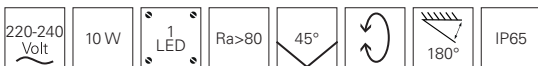

suitable outdoor mounting material ab page 1003



KEID

- aluminium diecast
- dimensions L x H x Ø: 120 x 211 x 75 mm
- socket H x Ø: 37 x 99 mm

732093 ■ dark grey  3000 K 1350 lm **139,95 €**

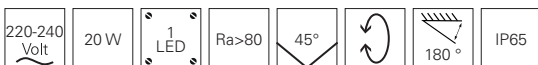

suitable outdoor mounting material ab page 1003



KEID II

- aluminium diecast
- dimensions L x H x Ø: 120 x 457 x 75 mm

732094 ■ dark grey ■ 3000 K ■ 800 lm **129,95 €**

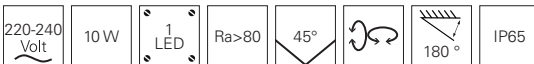

suitable outdoor mounting material ab page 1003



KEID II

- aluminium diecast
- dimensions L x H x Ø: 120 x 457 x 75 mm

732095 ■ dark grey ■ 3000 K ■ 1350 lm **139,95 €**

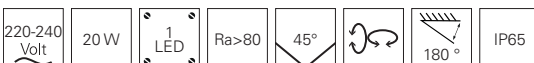

suitable outdoor mounting material ab page 1003



COLT

The new COLT series is a real all-rounder in the outdoor area: powerful, freely rotatable and tiltable and equipped with state-of-the-art LED technology. The surface-mounted luminaires thus provide atmospheric lighting concepts in any outdoor installation and also cut a good figure when switched off with their striking design.

COLT 4W COB

- aluminium diecast
- dimensions L x H x Ø: 65 x 120 x 50 mm
- socket H x Ø: 3 x 65 mm
- leading / trailing edge
- incl. 2 m connection cable with IP44 plug
- incl. 2 glass panes [transparent, milky]
- incl. 1 honeycomb filter



732104 ■ Black grey RAL 7021 ww 3000 K 240 lm

119,95 €



accessories

- 930426** ground spike | L: 170 mm
- 930428** lens 15°
- 930430** lens 60°

7,95 €

4,95 €

4,95 €

suitable energy distributors/socket towers on page 388
 suitable outdoor mounting material ab page 1003

COLT 8W COB

- aluminium diecast
- dimensions L x H x Ø: 65 x 185 x 76,50 mm
- socket H x Ø: 50 x 95 mm
- leading / trailing edge
- incl. 2 m connection cable with IP44 plug
- incl. 2 glass panes [transparent, milky]
- incl. 1 honeycomb filter



732108 ■ Black grey RAL 7021 ww 3000 K 470 lm

179,95 €

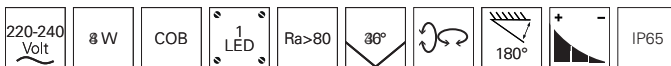

accessories

- 930441** housing | H: 41,5 mm
- 930426** ground spike | L: 170 mm
- 930431** reflector 12°
- 930432** reflector 22°

42,95 €

7,95 €

6,95 €

6,95 €

suitable energy distributors/socket towers on page 388
 suitable outdoor mounting material ab page 1003

COLT 15W COB

- aluminium diecast
- dimensions L x H x Ø: 88,30 x 220 x 110,50 mm
- socket H x Ø: 56 x 120 mm
- leading / trailing edge
- incl. 2 m connection cable with IP44 plug
- incl. 2 glass panes [transparent, milky]
- incl. 1 honeycomb filter



732109 ■ Black grey RAL 7021  3000 K 1090 lm

209,95 €



accessories

930442	housing H: 41,5 mm	52,95 €
930427	ground spike L: 219 mm	9,95 €
930434	reflector 12°	7,95 €
930435	reflector 22°	7,95 €

suitable energy distributors/socket towers on page 388
suitable outdoor mounting material ab page 1003

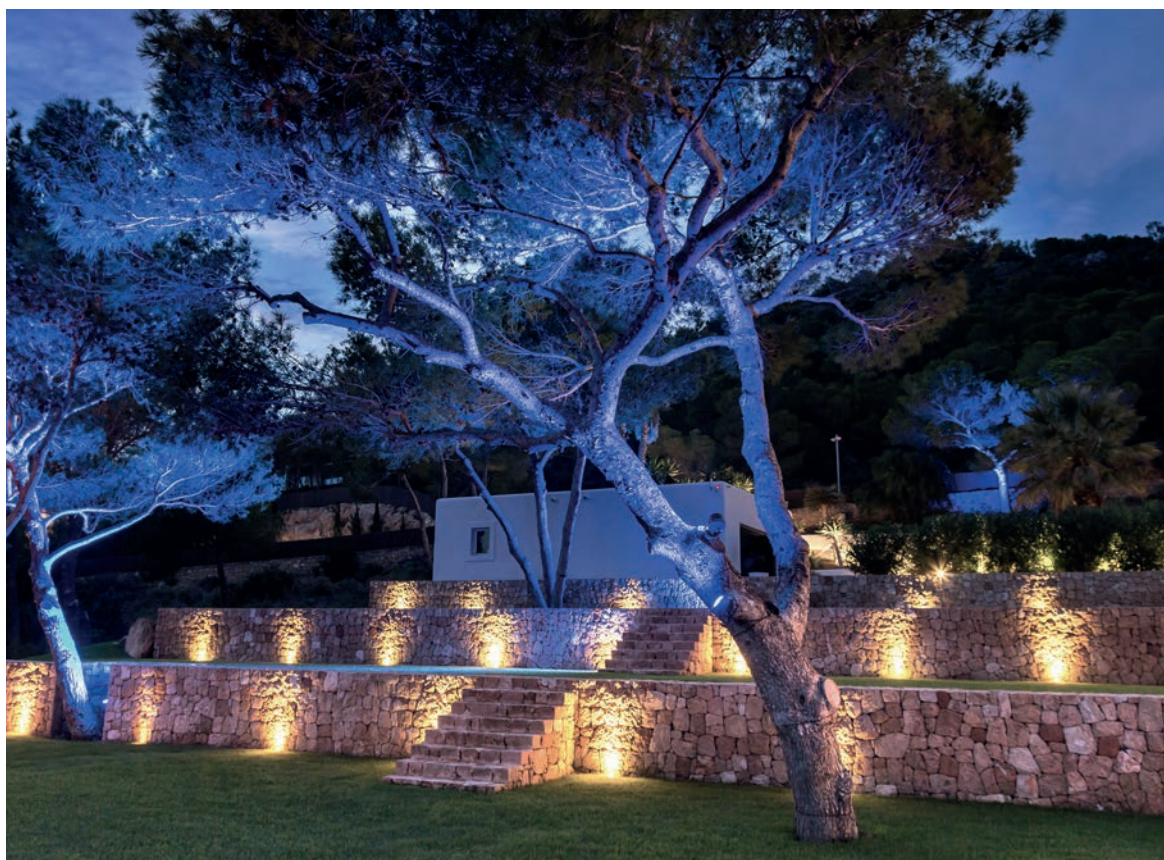

With the kind support of Loxone Lichtinstallation Eurotec-Ibiza@fotoeichhorn

COLT 30W COB

- aluminium diecast
- dimensions L x H x Ø: 111,80 x 260 x 131 mm
- socket H x Ø: 56 x 120 mm
- leading / trailing edge
- incl. 2 m connection cable with IP44 plug
- incl. 2 glass panes [transparent, milky]
- incl. 1 honeycomb filter



732110 ■ Black grey RAL 7021  3000 K 2320 lm

259,95 €

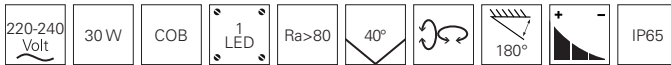

accessories

930442	housing H: 41,5 mm	52,95 €
930427	ground spike L: 219 mm	9,95 €
930437	reflector 12°	8,95 €
930438	reflector 22°	8,95 €

suitable energy distributors/socket towers on page 388
 suitable outdoor mounting material ab page 1003

COLT 65W COB

- aluminium diecast
- dimensions L x H x Ø: 162 x 192 x 182 mm
- socket H x Ø: 65 x 160 mm



732136 ■ Black grey RAL 7021  3000 K 5260 lm **479,95 €**

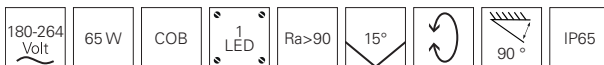

accessories

930567	reflector 30°	25,95 €
930568	reflector 45°	25,95 €
930569	reflector 70°	25,95 €

suitable energy distributors/socket towers on page 388
 suitable outdoor mounting material ab page 1003

COLT COB RGBW

- aluminium diecast
- dimensions L x Ø: 65 x 50 mm
- socket H x Ø: 7 x 65 mm
- dimmable via optional controller

732134 ■ Black grey RAL 7021

 2700 K

92 lm **179,95 €**



accessories

872041 power supply | 24V | 12,0 W | IP65

20,95 €

suitable controllers and dimmers from page 940
additional power supplies from page 896

COLT 8W RGBW

- aluminium diecast
- dimensions L x Ø: 66 x 78 mm
- socket H x Ø: 50 x 96 mm
- dimmable via optional controller
- incl. 2 m connection cable with IP44 plug
- incl. 2 glass panes [transparent, milky]
- incl. 1 honeycomb filter

732127 ■ Black grey RAL 7021

 3000 K

389 lm **269,95 €**

732123 ■ Black grey RAL 7021

 5500 K

485 lm **269,95 €**



accessories

930441 housing | H: 41,5 mm

42,95 €

930426 ground spike | L: 170 mm

7,95 €

872041 power supply | 24V | 12,0 W | IP65

20,95 €

suitable controllers and dimmers from page 940
additional power supplies from page 896

COLT 16W RGBW

- aluminium diecast
- dimensions L x Ø: 88 x 110 mm
- socket H x Ø: 56 x 120 mm
- incl. 2 m connection cable with IP44 plug
- incl. 2 glass panes [transparent, milky]
- incl. 1 honeycomb filter

732128	■ Black grey RAL 7021	RGB WW	3000 K	780 lm	399,95 €
732124	■ Black grey RAL 7021	RGB CW	5500 K	950 lm	399,95 €



accessories

930441	housing H: 41,5 mm	42,95 €
930426	ground spike L: 170 mm	7,95 €
872083	power supply 24V 40,0 W IP67	69,95 €

suitable controllers and dimmers from page 940
 additional power supplies from page 896



COLT 25W RGBW

- aluminium diecast
- dimensions L x Ø: 112 x 131 mm
- socket H x Ø: 56 x 120 mm
- incl. 2 m connection cable with IP44 plug
- incl. 2 glass panes [transparent, milky]
- incl. 1 honeycomb filter

732129	■ Black grey RAL 7021	RGB WW	3000 K	1140 lm	449,95 €
732125	■ Black grey RAL 7021	RGB CW	5500 K	1445 lm	449,95 €



accessories

930442	housing H: 41,5 mm	49,95 €
930427	ground spike L: 219 mm	9,95 €
872083	power supply 24V 40,0 W IP67	69,95 €

suitable controllers and dimmers from page 940
 additional power supplies from page 896



COLT 36W RGBWW

Even more powerful for more light output, freely rotatable and tiltable and equipped with state-of-the-art LED technology. With the COLT 36W RGBWW, even large objects, high facades and bridges can be put in the limelight.



COLT 36W RGBWW

- aluminium diecast
- dimensions L x H x Ø: 162 x 192 x 182 mm
- socket H x Ø: 65 x 160 mm
- dimmable via optional controller

732137 ■ Black grey RAL 7021  2700 K 1500 lm **599,95 €**



accessories

930558	housing H: 40,0 mm	79,95 €
930427	ground spike L: 219 mm	9,95 €
872083	power supply 24V 40,0 W IP67	69,95 €

suitable controllers and dimmers from page 940
additional power supplies from page 896





FLOOD FLEX I

- aluminium diecast
- dimensions L x W x H: 152,1 x 134,2 x 56 mm

732014 ■ Traffic grey RAL 7043  3000 K 700 lm **95,95 €**



suitable outdoor mounting material ab page 1003



FLOOD FLEX II

- aluminium diecast
- dimensions L x W x H: 200 x 152 x 56 mm

732016 ■ Traffic grey RAL 7043  3000 K 1100 lm **109,95 €**



suitable outdoor mounting material ab page 1003

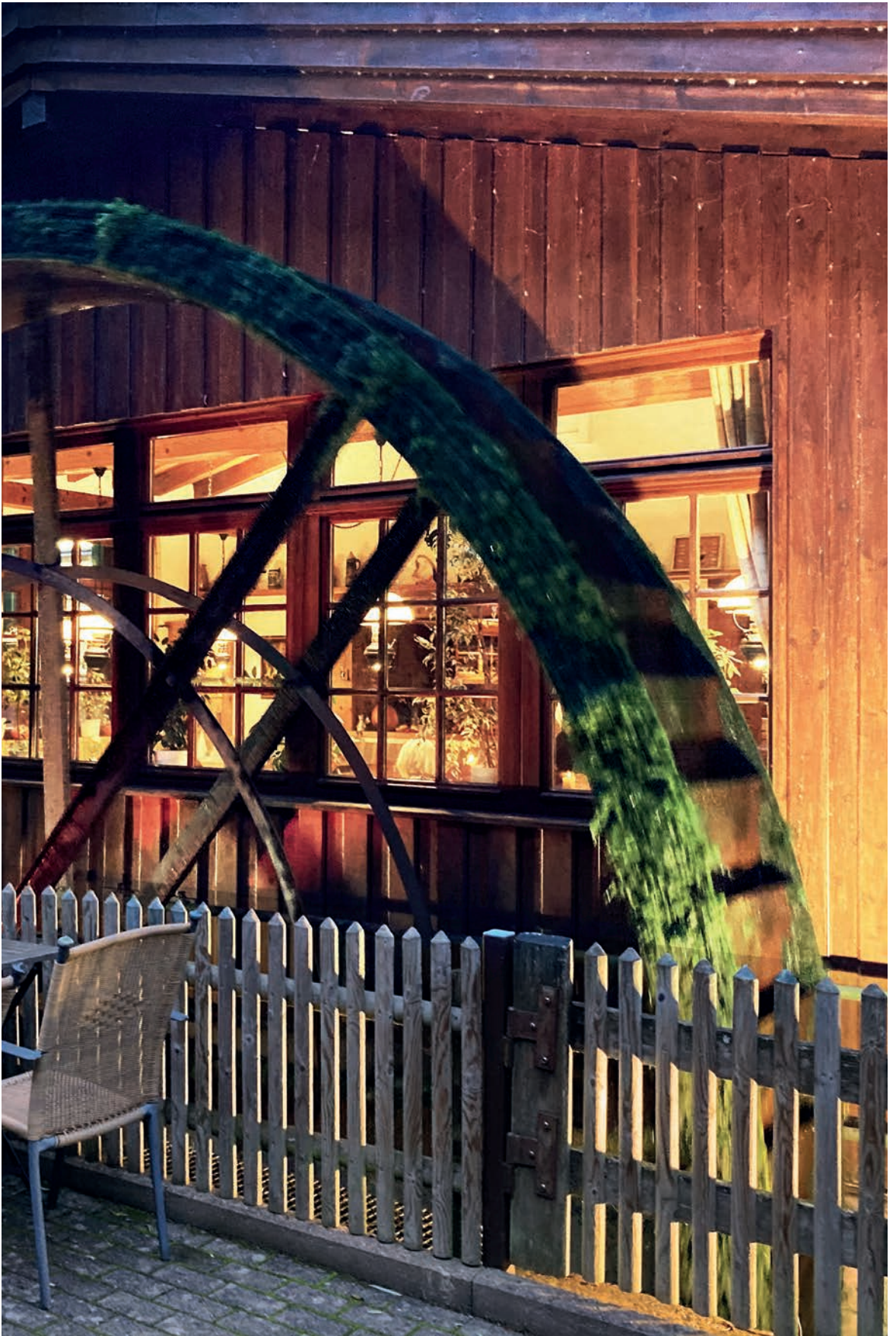

FLOOD RF II -10 RGB

- plastic
- dimensions L x W x H: 133 x 57 x 179 mm
- incl. 2 m connection cable with IP44 plug
- incl. remote control with min. 20 m range

732074 ■ Umbra grey RAL 7022  270 lm

139,95 €



suitable energy distributors/socket towers on page 388
suitable outdoor mounting material ab page 1003



FLOOD RF II -30 RGB

- plastic
- dimensions L x W x H: 178 x 81 x 215 mm
- incl. 2 m connection cable with IP44 plug
- incl. remote control with min. 20 m range

732075 ■ Umbra grey RAL 7022  1060 lm

245,95 €



suitable energy distributors/socket towers on page 388
suitable outdoor mounting material ab page 1003





FLOOD RF II -60 RGB

- plastic
- dimensions L x W x H: 200 x 98 x 253 mm
- incl. 2 m connection cable with IP44 plug
- incl. remote control with min. 20 m range

732076 ■ Umbra grey RAL 7022  2100 lm

353,95 €



suitable energy distributors/socket towers on page 388
 suitable outdoor mounting material ab page 1003

POWER SPOT III RGBWW

- aluminium diecast
- dimensions L x W x H: 235,6 x 182 x 66,2 mm
- dimmable via optional controller
- incl. 2 m connection cable

730179 ■ anthrazit  3000 K 1000 lm

415,95 €

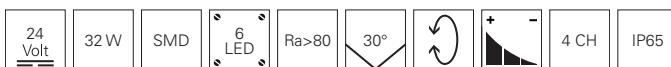

accessories

872083 power supply | 24V | 40,0 W | IP67

69,95 €

suitable controllers and dimmers from page 940
 additional power supplies from page 896



□
page 412



□
page 412



■
page 413



■
page 414



■
page 414



■
page 415



■
page 415





wall washer



MINI WALL WASHER I

- aluminium diecast
- dimensions L x W x H: 505 x 47 x 54 mm
- dimmable via optional controller
- inkl. 1 m connection cable with WEIPU socket [female]
- inkl. 1 m connection cable with WEIPU socket [male]

732019  silver coloured  3000 K 540 lm

139,95 €



accessories

- | | | |
|---------------|--|----------------|
| 872633 | power supply 24V DC 12,0 W IP20 | 19,95 € |
| 872083 | power supply 24V DC 40,0 W IP67 | 69,95 € |
| 843056 | RF single controller set dimmable 12/24/48V DC | 94,95 € |

suitable Weipu cables/connectors on page 995-997
 additional controller and dimmer from page 940
 additional power supplies from page 896



MINI WALL WASHER II

- aluminium diecast
- dimensions L x W x H: 1005 x 27 x 54 mm
- dimmable via optional controller
- inkl. 1 m connection cable with WEIPU socket [female]
- inkl. 1 m connection cable with WEIPU socket [male]

732022  silver coloured  3000 K 1040 lm

189,95 €



accessories

- | | | |
|---------------|--|----------------|
| 872636 | power supply 24V DC 20,0 W | 22,95 € |
| 872083 | power supply 24V DC 40,0 W IP67 | 69,95 € |
| 843056 | RF single controller set dimmable 12/24/48V DC | 94,95 € |

suitable Weipu cables/connectors on page 995-997
 additional controller and dimmer from page 940
 additional power supplies from page 896





LED STREET BAR MK II 16X8W RGBW 4IN1 IP65 30°

- aluminium
- dimensions L x W x H: 1069 x 85 x 140 mm
- DMX512
- 1/4/7/11/19/32/35 Channel mode
- manual colour adjustment without additional controller
- preset colours without additional controller
- Automatic programmes with adjustable speed
- Master/slave mode

730440 ■ black



584,95 €



accessories

180704 DMX connection cable Outdoor | 2 m

11,95 €

180705 DMX connection cable Outdoor | 5 m

21,95 €

180706 DMX connection cable Outdoor | 10 m

38,95 €

suitable DMX controllers from page 950

CAPH

Despite the linear design, the CAPH wallwasher range is a "round thing". The wallwashers offer a variety of possibilities to accentuate different objects. Be it the rustic stone wall in warm 3000 K or the modern new building in RGBW. The different optics with symmetrical or asymmetrical beam angles help with positioning.

With the 230 Volt versions, no further accessories are needed. Thanks to the 24 V versions, the CAPH wallwashers can be integrated into all control variants on the market - a »round thing«.

WALL WASHER CAPH SYMMETRIC

- aluminium diecast
- dimensions L x W x H: 1000 x 53,36 x 81,07 mm
- inkl. 2 m connection cable with IP44 plug

732079 ■ Graphite grey RAL 7024  3000 K



suitable energy distributors/plug-in socket towers on page 388
suitable outdoor mounting material from page 1003



3000 lm

339,95 €

WALL WASHER CAPH SYMMETRIC

- aluminium diecast
- dimensions L x W x H: 1000 x 53,36 x 81,07 mm
- dimmable via optional controller
- inkl. 0,5 m connection cable with WEIPU
- inkl. 0,5 m connection cable with WEIPU

732071 ■ Graphite grey RAL 7024  3000 K

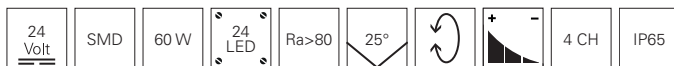

accessories

862164	power supply 24V DC 75,0 W IP20	74,95 €
872085	power supply 24V DC 75,0 W IP67	89,95 €
843059	RF color+white controller set dimmable 12/24/48V DC	109,95 €

suitable Weipu cables/connectors on page 995-997
additional controller and dimmer from page 940
additional power supplies from page 896



2800 lm

339,95 €

WALL WASHER CAPH ASYMMETRIC

- aluminium diecast
- dimensions L x W x H: 1000 x 53,36 x 81,07 mm
- inkl. 2 m connection cable with IP44 plug

732080 ■ Graphite grey RAL 7024 ■ 3000 K



2580 lm

339,95 €



suitable energy distributors/plug-in socket towers on page 388
 suitable outdoor mounting material from page 1003

WALL WASHER CAPH ASYMMETRIC

- aluminium diecast
- dimensions L x W x H: 1000 x 53,36 x 81,07 mm
- dimmable via optional controller
- inkl. 0,5 m connection cable with WEIPU
- inkl. 0,5 m connection cable with WEIPU

732072 ■ Graphite grey RAL 7024 ■ ■ ■ 3000 K



2480 lm

339,95 €

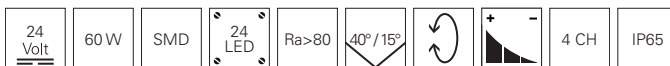

accessories

862164	power supply 24V DC 75,0 W IP20	74,95 €
872085	power supply 24V DC 75,0 W IP67	89,95 €
843059	RF color+white controller set dimmable 12/24/48V DC	109,95 €

suitable Weipu cables/connectors on page 995-997
 additional controller and dimmer from page 940
 additional power supplies from page 896





□
page 432



□
page 434



□
page 434



□
page 435



□
page 435



□
page 436

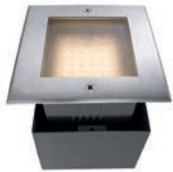

□
page 436



□
page 437



□
page 438



□
page 438



□
page 439



□
page 439

ground recessed lights



■ page 440



■ page 440



■ page 441



□ page 443



□ page 443



□ page 444



□ page 445



□ page 445



□ page 446



□ page 446



□ page 448



□ page 448



□ page 449

ATON, PHAKT UND PAVO

Simple and good - with their robust construction, the ATON, PHAKT and PAVO series provide elegant recessed floor lighting at a low price.

The interchangeable light sources allow an individual lighting solution with vision.

ATON ROUND SET

- plastic / plastic
- dimensions H x Ø: 111 x 97 mm
- dimmable via optional illuminants

730474 ■ silver coloured / black **45,95 €**



GU10 suitable illuminants on page 969-970
suitable outdoor mounting material from page 1003



PHAKT ROUND SET

- plastic / plastic
- dimensions H x Ø: 156 x 136 mm
- dimmable via optional illuminants

730476 ■ silver coloured / black **56,95 €**



GU10 suitable illuminants on page 974-977
suitable outdoor mounting material from page 1003



PAVO ROUND SET

- stainless steel / aluminium / plastic
- dimensions H x Ø: 156 x 139 mm
- dimmable via optional illuminants

730478 ■ black **89,95 €**



GU10 suitable illuminants on page 969-970
suitable outdoor mounting material from page 1003



ATON ANGULAR SET

- plastic / plastic
- dimensions H x Ø: 111 x 97 mm
- dimmable via optional illuminants

730475  silver coloured / black **49,95 €**



GU10 suitable illuminants on page 969-970
suitable outdoor mounting material from page 1003



PHAKT ANGULAR SET

- plastic / plastic
- dimensions H x Ø: 156 x 136 mm
- dimmable via optional illuminants

730477  silver coloured / black **59,95 €**



GU10 suitable illuminants on page 974-977
suitable outdoor mounting material from page 1003



PAVO ANGULAR SET

- stainless steel / aluminium / plastic
- dimensions H x Ø: 156 x 139 mm
- dimmable via optional illuminants

730479  black **99,95 €**



GU10 suitable illuminants on page 969-970
suitable outdoor mounting material from page 1003





BASIC IWW

- stainless steel / aluminium diecast
- dimensions H x Ø: 65 x 45 mm
- dimmable via optional controller
- incl. 0,5 m connection cable with WEIPU plug

730339	<input type="checkbox"/>	silver coloured round		3000 K	15 lm	53,95 €
730340	<input type="checkbox"/>	silver coloured square		3000 K	14 lm	53,95 €

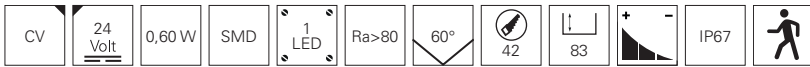

accessories

872041	power supply 24V DC 12,0 W IP66	20,95 €
872083	power supply 24V 40,0 W IP67	69,95 €
843056	RF single controller set dimmable 12/24/48V DC	94,95 €

suitable Weipu cables/connectors on page 995-997
 additional controller and dimmer from page 940
 additional power supplies from page 896



ALZIRR II

- stainless steel / aluminium diecast
- dimensions H x Ø: 82,50 x 55 mm
- dimmable via optional controller
- incl. 1 m connection cable with WEIPU plug



730470 silver coloured 3000 K 150 lm **74,95 €**



accessories

872041	power supply 24V DC 12,0 W IP66	20,95 €
872083	power supply 24V 40,0 W IP67	69,95 €
843056	RF single controller set dimmable 12/24/48V DC	94,95 €

suitable Weipu cables/connectors on page 995-997
 additional controller and dimmer from page 940
 additional power supplies from page 896



FORNAC

- stainless steel / aluminium diecast
- dimensions H x Ø: 80 x 55 mm
- asymmetric
- dimmable via optional controller
- incl. 1 m connection cable with WEIPU plug [male]



730447 silver coloured  3000 K 110 lm

96,95 €



accessories

872041 power supply | 24V DC | 12,0 W | IP66

20,95 €

872083 power supply | 24V | 40,0 W | IP67

69,95 €

843056 RF single controller set dimmable | 12/24/48V DC

94,95 €

suitable Weipu cables/connectors on page 995-997
 additional controller and dimmer from page 940
 additional power supplies from page 896

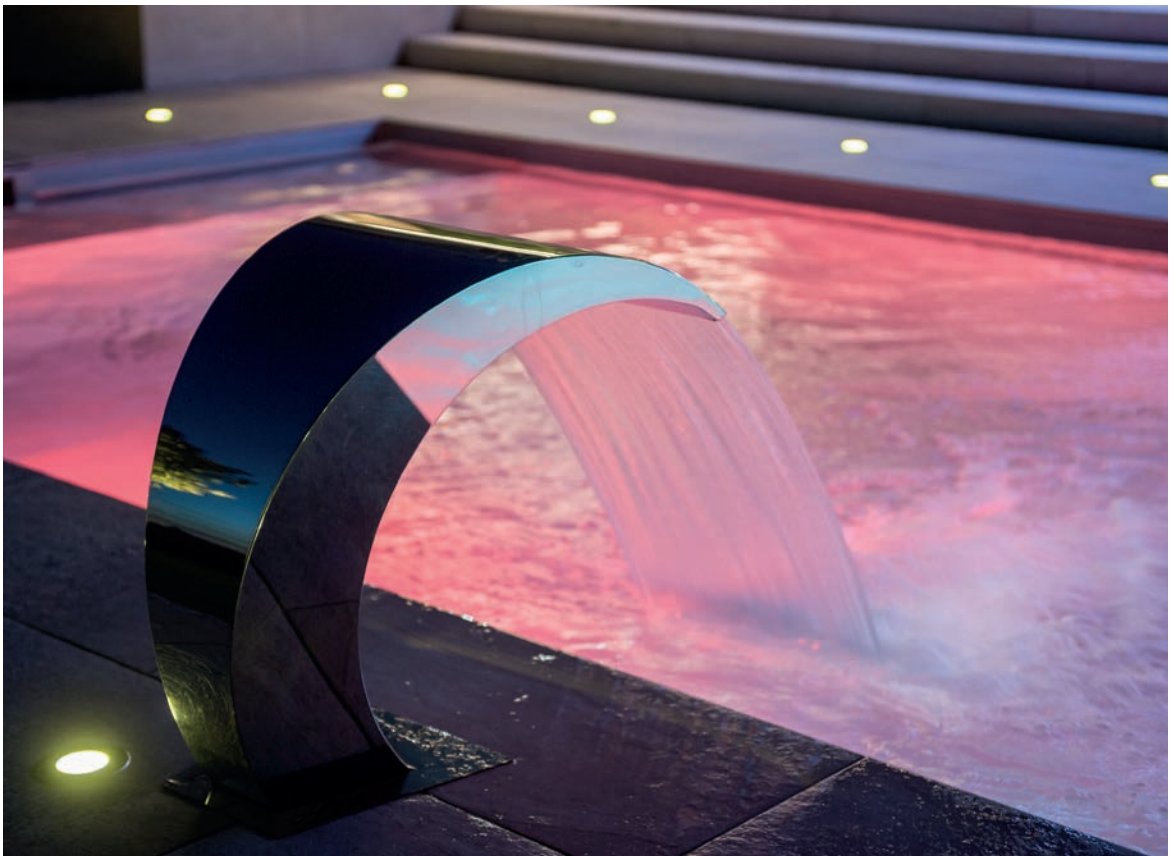

With the kind support of Licht von Klein / www.licht-von-klein.de



NC COB I

- aluminium diecast
- dimensions L x Ø: 90 x 63 mm
- incl. 0,5 m connection cable with with protected junction box

730439	■ black round	ww 3000 K	520 lm	163,95 €
730438	■ black square	ww 3000 K	520 lm	163,95 €

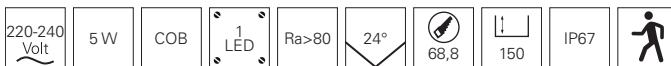

suitable outdoor mounting material from page 1003



EASY COB III WW

- stainless steel / aluminium diecast
- dimensions H x Ø: 96 x 70 mm
- dimmable via optional controller
- incl. 1 m connection cable with WEIPU plug

730469	□ silver coloured round	ww 3000 K	330 lm	119,95 €
730468	□ silver coloured square	ww 3000 K	330 lm	119,95 €



accessories

872041	power supply 24V DC 12,0 W IP66	20,95 €
872083	power supply 24V 40,0 W IP67	69,95 €
843056	RF single controller set dimmable 12/24/48V DC	94,95 €

suitable Weipu cables/connectors on page 995-997
 additional controller and dimmer from page 940
 additional power supplies from page 896



PEACOCK

- stainless steel / aluminium diecast
- dimensions H x Ø: 43 x 58 mm
- incl. 0,5 m connection cable with with protected junction box

730459  silver coloured  3000 K 150 lm **96,95 €**

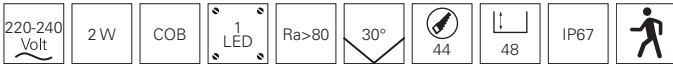

suitable outdoor mounting material from page 1003



With the kind support of Alpbtherme Waldbronn / Ziegler Technics

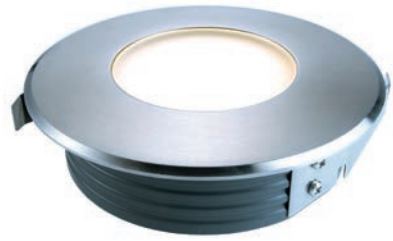

FLAT III WW

- stainless steel / aluminium diecast
- dimensions H x Ø: 42 x 116 mm
- incl. 0,5 m connection cable

730336 silver coloured ww 3000 K 25 lm **129,95 €**



suitable outdoor mounting material from page 1003



FLAT II

- stainless steel / aluminium diecast
- dimensions H x Ø: 42 x 116 mm
- incl. 0,5 m connection cable

100111 silver coloured ww 3000 K 400 lm **162,95 €**

100112 silver coloured cw 6000 K 450 lm **162,95 €**





suitable outdoor mounting material from page 1003



FLAT I WW

- stainless steel / aluminium diecast
- dimensions H x Ø: 38 x 173 mm
- incl. 0,5 m connection cable

100114  silver coloured  3000 K 860 lm

206,95 €



suitable outdoor mounting material from page 1003



FLAT I RGB

- stainless steel / aluminium diecast
- dimensions H x Ø: 38 x 173 mm
- dimmable via optional controller
- incl. 0,5 m connection cable with WEIPU plug

100116  silver coloured  510 lm

239,95 €



accessories

872083 power supply | 24V | 40,0 W | IP67

69,95 €

843058 RF RGB controller set dimmable | 12/24/48V DC

104,95 €

suitable Weipu cables/connectors on page 995-997

additional controller and dimmer from page 940

additional power supplies from page 896



GROUND RECESSED LIGHT II WW

- stainless steel / aluminium diecast
- dimensions H x Ø: 102 x 116 mm
- incl. 0,5 m connection cable

730255  silver coloured  3000 K 280 lm

149,95 €





suitable outdoor mounting material from page 1003



GROUND RECESSED LIGHT I WW

- stainless steel / aluminium diecast
- dimensions H x Ø: 102 x 116 mm
- dimmable via optional controller
- incl. 1 m connection cable with WEIPU plug

100133  silver coloured  3000 K 370 lm

139,95 €



accessories

- 872041** power supply | 24V DC | 12,0 W | IP66 **20,95 €**
- 872083** power supply | 24V | 40,0 W | IP67 **69,95 €**
- 843056** RF single controller set dimmable | 12/24/48V DC **94,95 €**

suitable Weipu cables/connectors on page 995-997
 additional controller and dimmer from page 940
 additional power supplies from page 896



TALL COB I WW

- stainless steel / aluminium diecast
- dimensions H x Ø: 102 x 116 mm
- incl. 0,5 m connection cable

730211  silver coloured  3000 K 720 lm **159,95 €**

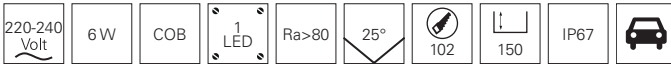

suitable outdoor mounting material from page 1003



With the kind support of Licht von Klein / www.licht-von-klein.de



HP I WW

- stainless steel / aluminium diecast
- dimensions H x Ø: 111 x 173 mm
- incl. 0,5 m connection cable

730249 silver coloured 3000 K 540 lm **192,95 €**



suitable outdoor mounting material from page 1003



HP II WW

- stainless steel / aluminium diecast
- dimensions H x Ø: 111 x 173 mm
- incl. 0,5 m connection cable

730250 silver coloured 3000 K 920 lm **203,95 €**



suitable outdoor mounting material from page 1003



GROUND RECESSED LIGHT

- stainless steel / aluminium diecast
- dimensions H x Ø: 111 x 173 mm
- asymmetric
- incl. 0,5 m connection cable

730289  silver coloured  3000 K 700 lm



suitable outdoor mounting material from page 1003

215,95 €



HP IV WW

- stainless steel / aluminium diecast
- dimensions H x Ø: 111 x 173 mm
- asymmetric
- dimmable via optional controller
- incl. 0,5 m connection cable with WEIPU plug

730296  silver coloured  3000 K 800 lm



accessories

872083 power supply | 24V | 40,0 W | IP67

69,95 €

843056 RF single controller set dimmable | 12/24/48V DC

94,95 €

suitable Weipu cables/connectors on page 995-997

additional controller and dimmer from page 940

additional power supplies from page 896





COB 12 SOFT WW

- stainless steel / aluminium diecast
- dimensions L x Ø: 128 x 173 mm
- incl. 0,5 m connection cable
- incl. honeycomb filter

730420  silver coloured brushed  3000 K 900 lm **375,95 €**

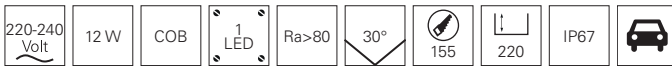

suitable outdoor mounting material from page 1003



COB 25 SOFT WW

- stainless steel / aluminium diecast
- dimensions L x Ø: 190 x 250 mm
- incl. 0,5 m connection cable
- incl. honeycomb filter

730421  silver coloured brushed  3000 K 1650 lm **525,95 €**

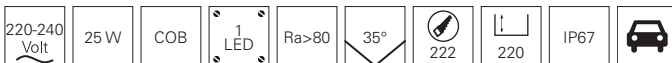

suitable outdoor mounting material from page 1003



SOFT FLEX 7

- stainless steel / aluminium diecast
- dimensions H x Ø: 128 x 173 mm
- radiation direction adjustable
- incl. 1 m connection cable
- incl. honeycomb filter

730267 silver coloured 3000 K 480 lm **309,95 €**



suitable outdoor mounting material from page 1003



SOFT FLEX 18

- stainless steel / aluminium diecast
- dimensions L x Ø: 190 x 250 mm
- incl. 1 m connection cable
- incl. honeycomb filter

730266 silver coloured 3000 K 770 lm **534,95 €**





suitable outdoor mounting material from page 1003



SQUARE COB I WW

- stainless steel / aluminium diecast
- dimensions L x W x H: 125 x 125 x 75 mm
- incl. 0,5 m connection cable

730209  silver coloured  3000 K 700 lm **139,95 €**

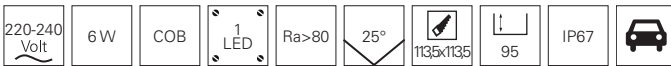

suitable outdoor mounting material from page 1003



SQUARE II WW

- stainless steel / aluminium diecast
- dimensions L x W x H: 125 x 125 x 75 mm
- incl. 0,5 m connection cable
- incl. 2 glass panes [prism, white]

730248  silver coloured  3000 K 160 lm **149,95 €**

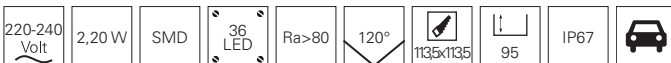



suitable outdoor mounting material from page 1003



SQUARE IWWA

- stainless steel / aluminium diecast
- asymmetric
- dimensions L x W x H: 160 x 160 x 79 mm
- incl. 0,5 m connection cable

730199  silver coloured  3000 K 400 lm **209,95 €**



suitable outdoor mounting material from page 1003

EASY SQUARE II RGB

- stainless steel / aluminium diecast
- dimensions L x W x H: 55 x 55 x 99 mm
- dimmable via optional controller
- incl. 0,5 m connection cable with WEIPU plug

730244 silver coloured RGB 80 lm

139,95 €



accessories

872083 power supply | 24V | 40,0 W | IP67

69,95 €

843058 RF RGB controller set dimmable | 12/24/48V DC

104,95 €

suitable Weipu cables/connectors on page 995-997
additional controller and dimmer from page 940
additional power supplies from page 896



GROUND RECESSED LIGHT III RGB

- stainless steel / aluminium diecast
- dimensions H x Ø: 102 x 116 mm
- dimmable via optional controller
- incl. 0,5 m connection cable with WEIPU plug

730276 silver coloured RGB 280 lm

139,95 €



accessories

872083 power supply | 24V | 40,0 W | IP67

69,95 €

843058 RF RGB controller set dimmable | 12/24/48V DC

104,95 €

suitable Weipu cables/connectors on page 995-997
additional controller and dimmer from page 940
additional power supplies from page 896



HOROLOGII

- stainless steel / aluminium diecast
- dimensions H x Ø: 79 x 116 mm
- dimmable via optional controller
- incl. 0,5 m connection cable with WEIPU plug [male]

730449 silver coloured RGB CW 5700-7000 K 257 lm



accessories

872083 power supply | 24V | 40,0 W | IP67

69,95 €

843059 RF RGB+white controller set dimmable | 12/24/48V DC

109,95 €

suitable Weipu cables/connectors on page 995-997
 additional controller and dimmer from page 940
 additional power supplies from page 896



175,95 €

CANUM

- stainless steel / aluminium diecast
- dimensions H x Ø: 111 x 173 mm
- dimmable via optional controller
- incl. 0,5 m connection cable with WEIPU plug

730454 silver coloured RGB 510 lm



accessories

872083 power supply | 24V | 40,0 W | IP67

69,95 €

843058 RF RGB controller set dimmable | 12/24/48V DC

104,95 €

suitable Weipu cables/connectors on page 995-997
 additional controller and dimmer from page 940
 additional power supplies from page 896



299,95 €



HELIOS I

- aluminium diecast
- dimensions H x Ø: 54 x 210 mm
- socket H x Ø: 25 x 165 mm
- incl. 4 heavy duty anchor

732143 ■ Slate grey RAL 7015  3000 K 34 lm **105,95 €**

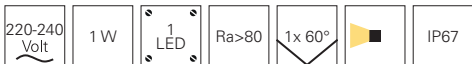

suitable outdoor mounting material from page 1003



HELIOS II

- aluminium diecast
- dimensions H x Ø: 50 x 210 mm
- socket H x Ø: 7 x 198 mm
- incl. 4 heavy duty anchor

732049 ■ Slate grey RAL 7015  3000 K 65 lm **105,95 €**

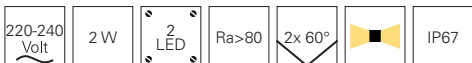

suitable outdoor mounting material from page 1003

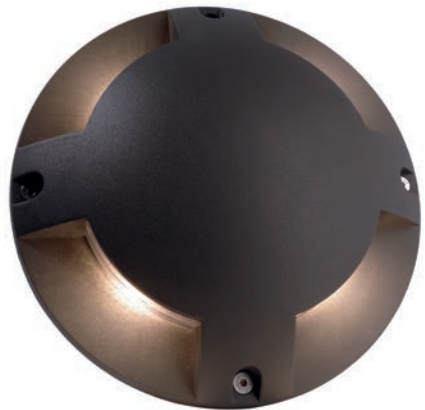

HELIOS IV

- aluminium diecast
- dimensions H x Ø: 50 x 210 mm
- socket H x Ø: 7 x 198 mm
- incl. 4 heavy duty anchor

732050 ■ Slate grey RAL 7015  3000 K 150 lm **109,95 €**

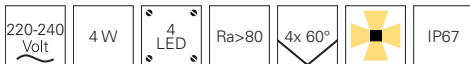

suitable outdoor mounting material from page 1003

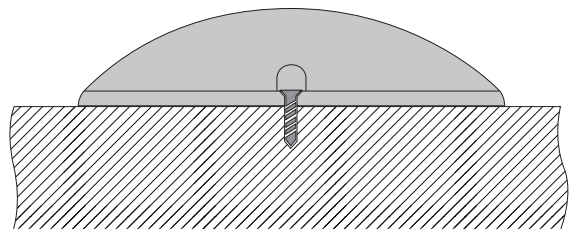
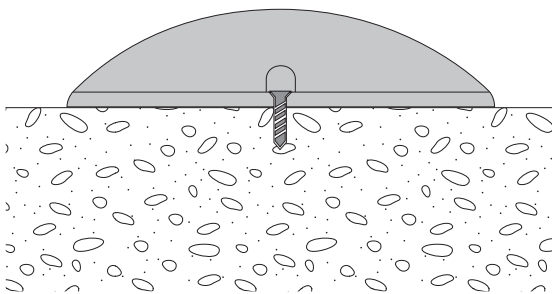





With the kind support of Elektro Grün 67434 Neustadt an der Weinstraße firma@elektrogruen.de



LINE IV 1.9WW

- stainless steel / aluminium diecast
- dimensions L x W x H: 195 x 63 x 65 mm
- incl. 1 m connection cable

100108  silver coloured  3000 K 35 lm **135,95 €**

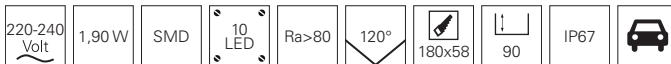



suitable outdoor mounting material from page 1003



LINE IV 3.7WW

- stainless steel / aluminium diecast
- dimensions L x W x H: 328 x 63 x 65 mm
- incl. 1 m connection cable

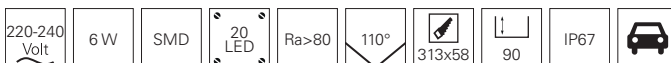

100109  silver coloured  3000 K 85 lm **179,95 €**



suitable outdoor mounting material from page 1003

LINE I WW

- stainless steel / aluminium diecast
- dimensions L x W x H: 195 x 63 x 65 mm
- asymmetric
- incl. 0,5 m connection cable

730292  silver coloured  3000 K 340 lm **149,95 €**



suitable outdoor mounting material from page 1003



With the kind support of Licht von Klein / www.licht-von-klein.de



LINE II WW

- stainless steel / aluminium diecast
- dimensions L x W x H: 328 x 63 x 65 mm
- asymmetric
- incl. 1 m connection cable

730262  silver coloured  3000 K 730 lm **215,95 €**



suitable outdoor mounting material from page 1003



LINE II WWA

- stainless steel / aluminium diecast
- dimensions L x W x H: 328 x 63 x 65 mm
- asymmetric
- dimmable via optional controller
- incl. 0,5 m connection cable with WEIPU plug

730008  silver coloured  3000 K 750 lm **215,95 €**



accessories

872083 power supply | 24V | 40,0 W | IP67 **69,95 €**

843056 RF single controller set dimmable | 12/24/48V DC **94,95 €**

suitable Weipu cables/connectors on page 995-997
 additional controller and dimmer from page 940
 additional power supplies from page 896



LINE V WW

- stainless steel / aluminium diecast
- dimensions L x W x H: 549 x 68 x 31,5 mm
- incl. 0,5 m connection cable

730434  silver coloured  3000 K 1100 lm **319,95 €**



suitable outdoor mounting material from page 1003



LINE VI WW

- stainless steel / aluminium diecast
- dimensions L x W x H: 1025 x 68 x 80 mm
- incl. 0,5 m connection cable

730432  silver coloured  3000 K 2300 lm **529,95 €**

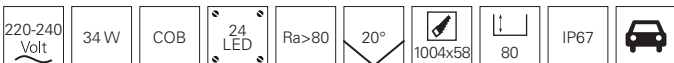

suitable outdoor mounting material from page 1003

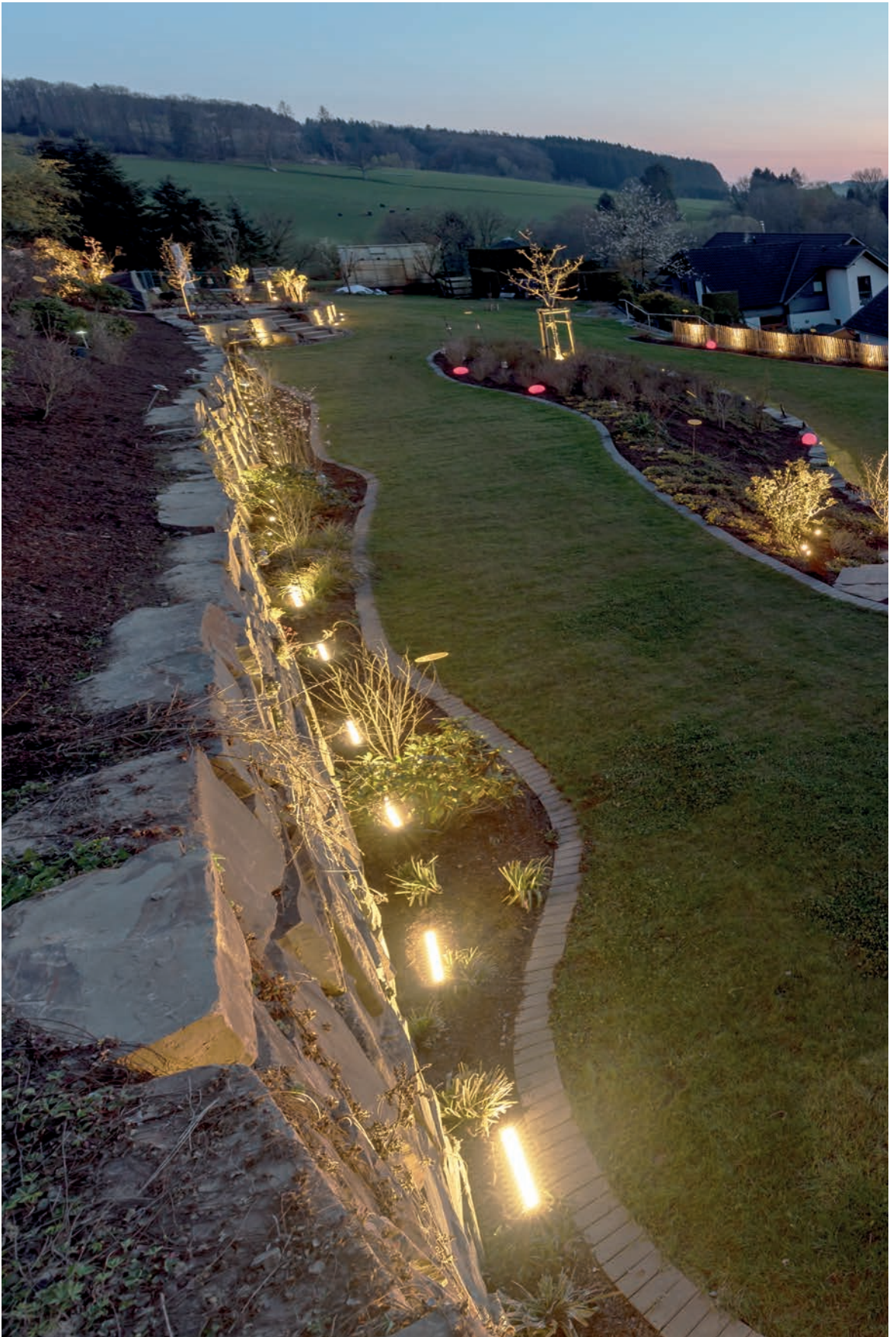

LINE III RGB

- stainless steel / aluminium diecast
- dimensions L x W x H: 328 x 63 x 65 mm
- dimmable via optional controller
- incl. 0,5 m connection cable with WEIPU plug



730263 silver coloured **RGB** 400 lm **265,95 €**



accessories

872083 power supply | 24V | 40,0 W | IP67 **69,95 €**

843058 RF RGB controller set dimmable | 12/24/48V DC **104,95 €**

suitable Weipu cables/connectors on page 995-997
additional controller and dimmer from page 940
additional power supplies from page 896

LINE V RGB

- stainless steel / aluminium diecast
- dimensions L x W x H: 549 x 68 x 32,5 mm
- dimmable via optional controller
- incl. 0,5 m connection cable with WEIPU plug



730437 silver coloured **RGB** 340 lm **374,95 €**



accessories

872083 power supply | 24V | 40,0 W | IP67 **69,95 €**

843058 RF RGB controller set dimmable | 12/24/48V DC **104,95 €**

suitable Weipu cables/connectors on page 995-997
additional controller and dimmer from page 940
additional power supplies from page 896



LINE VI RGB

- stainless steel / aluminium diecast
- dimensions L x W x H: 1025 x 68 x 31,5 mm
- dimmable via optional controller
- incl. 0,5 m connection cable with WEIPU plug

730436 silver coloured  700 lm **589,95 €**

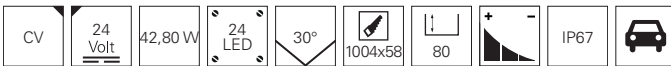

accessories

872085	power supply 24V 75,0 W IP67	89,95 €
872094	power supply 24V 100,0 W IP67	109,95 €
843058	RF RGB controller set dimmable 12/24/48V DC	104,95 €

suitable Weipu cables/connectors on page 995-997
 additional controller and dimmer from page 940
 additional power supplies from page 896



page 452

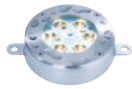

page 453



page 453



page 454



page 455



page 456



page 457



page 458



underwater lights



SNAPPER II WW

- stainless steel
- dimensions H x Ø: 73 x 68,5 mm
- dimmable via optional controller
- incl. 10 m connection cable with WEIPU plug IP67

740007 silver coloured **ww** 3000 K 105 lm

128,95 €

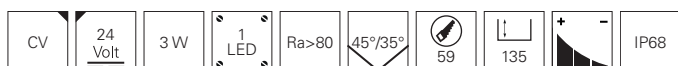

accessories

872045 LED safety transformer dimmable | 24V DC | 60,0 W

299,95 €

843056 RF single controller set dimmable | 12/24/48V DC

94,95 €

suitable Weipu cables/connectors on page 995-997
 additional controller and dimmer from page 940
 additional power supplies from page 896

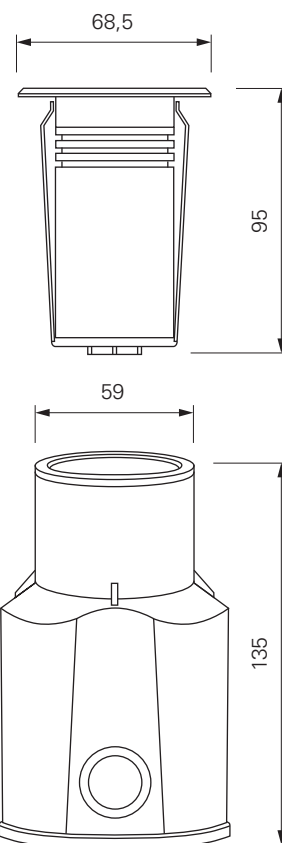

SHARK I WW

- stainless steel
- dimensions H x Ø: 33 x 115 mm
- dimmable via optional controller
- incl. 10 m connection cable with WEIPU plug IP67



785016 silver coloured  3000 K 770 lm

225,95 €

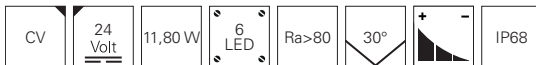

accessories

872045	LED safety transformer dimmable 24V DC 60,0 W	299,95 €
872046	LED safety transformer dimmable 24V DC 150,0 W	399,95 €
843056	RF single controller set dimmable 12/24/48V DC	94,95 €

suitable Weipu cables/connectors on page 995-997
 additional controller and dimmer from page 940
 additional power supplies from page 896

SHARK I RGB

- stainless steel
- dimensions H x Ø: 33 x 115 mm
- dimmable via optional controller
- incl. 10 m connection cable with WEIPU plug IP67



785017 silver coloured  400 lm

265,95 €

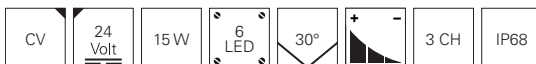

accessories



872045	LED safety transformer dimmable 24V DC 60,00W	299,95 €
872046	LED safety transformer dimmable 24V DC 150,00 W	399,95 €
843058	RF RGB controller set dimmable 12/24/48V DC	104,95 €

suitable Weipu cables/connectors on page 995-997
 additional controller and dimmer from page 940
 additional power supplies from page 896

FIARA

- stainless steel
- dimensions L x W x H x Ø: 95 x 106 x 150 x 95 mm
- socket L x W x H: 65 x 40 x 60 mm
- dimmable via optional controller
- incl. 10 m connection cable with WEIPU plug IP 67



740005  silver coloured  3000 K 670 lm **309,95 €**

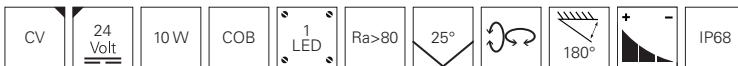

accessories

872045	LED safety transformer dimmable 24V DC 60,0 W	299,95 €
872046	LED safety transformer dimmable 24V DC 150,0 W	399,95 €
843056	RF single controller set dimmable 12/24/48V DC	94,95 €

suitable Weipu cables/connectors on page 995-997
 additional controller and dimmer from page 940
 additional power supplies from page 896

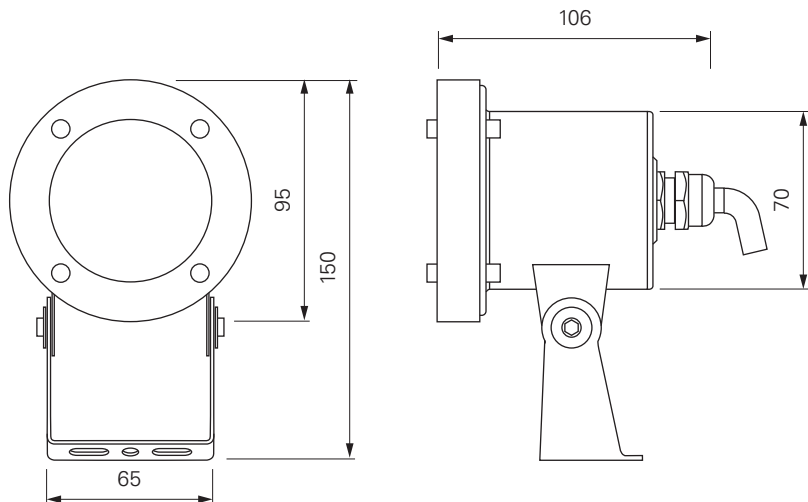



FIARA

- stainless steel
- dimensions L x W x H x Ø: 95 x 106 x 150 x 95 mm
- socket L x W x H: 65 x 40 x 60 mm
- dimmable via optional controller
- incl. 10 m connection cable with WEIPU plug IP 67

740008  silver coloured  280 lm **289,95 €**

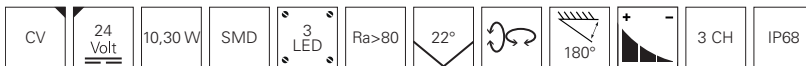

accessories

872045 LED safety transformer dimmable | 24V DC | 60,00W **299,95 €**
872046 LED safety transformer dimmable | 24V DC | 150,00 W **399,95 €**
843058 RF RGB controller set dimmable | 12/24/48V DC **104,95 €**

suitable Weipu cables/connectors on page 995-997
 additional controller and dimmer from page 940
 additional power supplies from page 896

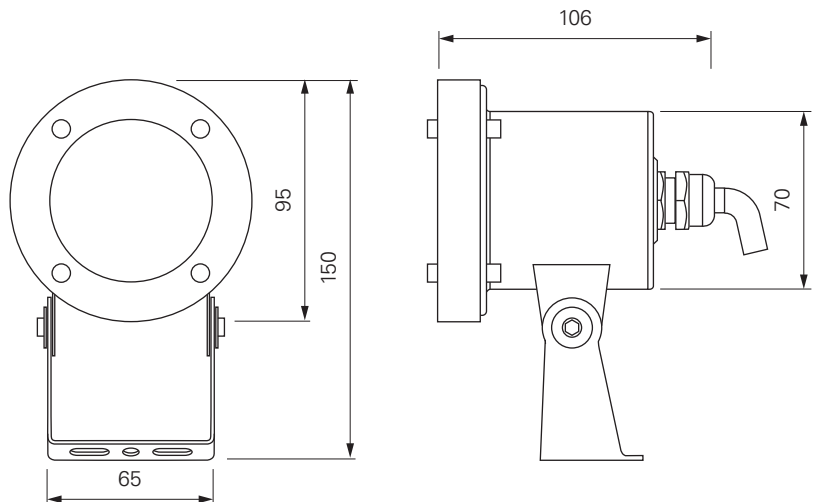

FIARA

- stainless steel
- dimensions L x W x H x Ø: 127 x 120 x 195 x 127 mm
- socket L x W x H: 93 x 50 x 80 mm
- dimmable via optional controller
- incl. 10 m connection cable with WEIPU plug IP 67



740006  silver coloured  3000 K 1200 lm **359,95 €**

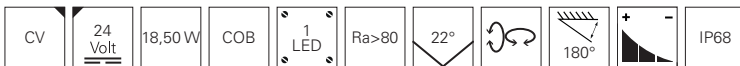

accessories

872045	LED safety transformer dimmable 24V DC 60,0 W	299,95 €
872046	LED safety transformer dimmable 24V DC 150,0 W	399,95 €
843056	RF single controller set dimmable 12/24/48V DC	94,95 €

suitable Weipu cables/connectors on page 995-997
 additional controller and dimmer from page 940
 additional power supplies from page 896

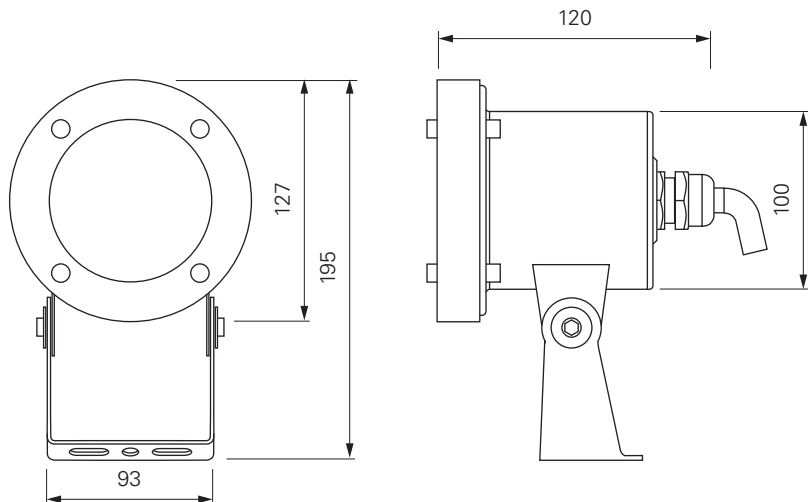



FIARA

- stainless steel
- dimensions L x W x H x Ø: 127 x 120 x 195 x 127 mm
- socket L x W x H: 93 x 50 x 80 mm
- dimmable via optional controller
- incl. 10 m connection cable with WEIPU plug IP 67

740009  silver coloured  280 lm **319,95 €**

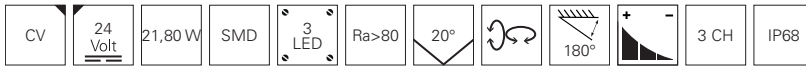

accessories

872045	LED safety transformer dimmable 24V DC 60,00W	299,95 €
872046	LED safety transformer dimmable 24V DC 150,00 W	399,95 €
843058	RF RGB controller set dimmable 12/24/48V DC	104,95 €

suitable Weipu cables/connectors on page 995-997
 additional controller and dimmer from page 940
 additional power supplies from page 896

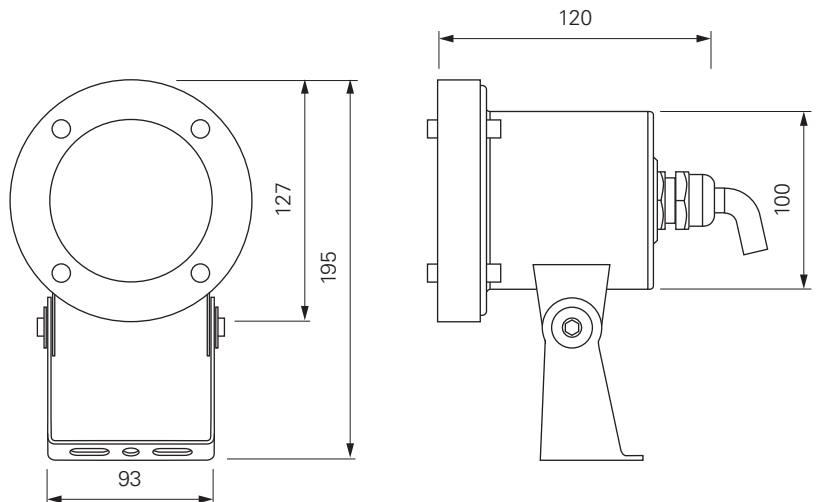



CORAL IWW

- stainless steel
- dimensions L x W x H: 211 x 60 x 65 mm
- dimmable via optional controller
- incl. 10 m connection cable with WEIPU plug IP67

730134  silver coloured  3000 K 710 lm

269,95 €

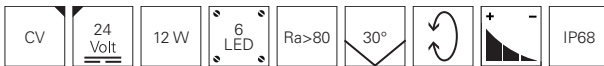

accessories

872045	LED safety transformer dimmable 24V DC 60,0 W	299,95 €
872046	LED safety transformer dimmable 24V DC 150,0 W	399,95 €
843056	RF single controller set dimmable 12/24/48V DC	94,95 €

suitable Weipu cables/connectors on page 995-997

additional controller and dimmer from page 940

additional power supplies from page 896

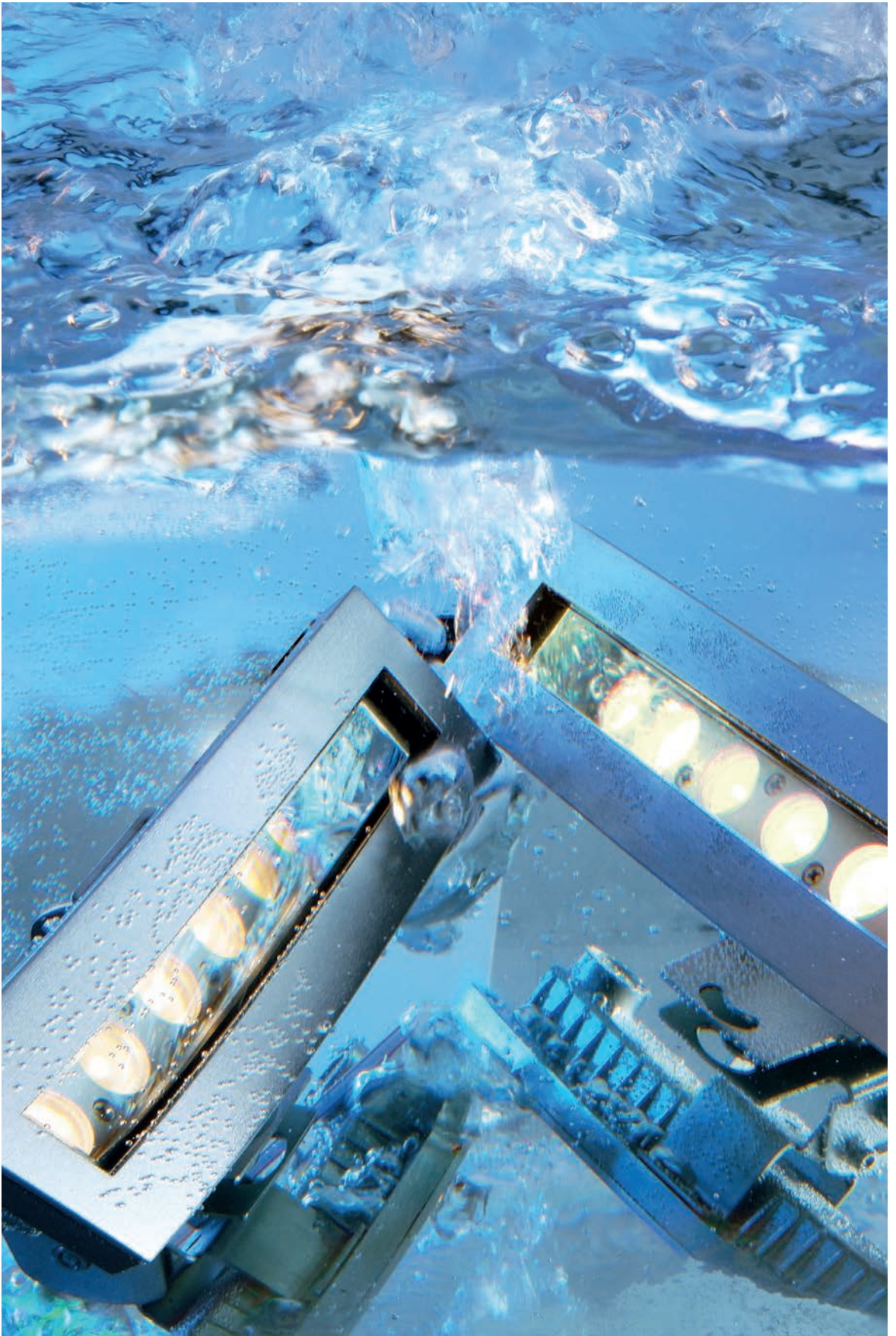



COMMERCIAL LIGHTS

- 466 built in ceiling lights
- 494 insert panels
- 516 ceiling and wall lights
- 538 pendant lamps
- 554 floor lights
- 564 hall floodlight
- 574 damp-proof luminaires
- 584 floodlight
- 596 display lights
- 600 effect lights
- 608 emergency lights

POWER RAIL

- 616 D LINE power rail system
- 644 power rail spotlights

CONTEMPORARY LIGHTING SOLUTIONS FOR A MODERN WORKING WORLD

For a long time, the requirements for commercially used luminaires - also known as industrial luminaires – were straightforward: they had to be bright, reliable and low-maintenance, while complying with current directives and standards. These core factors remain unchanged today [even more so with regard to energy efficiency]. But apart from these purely functional properties, modern companies – whether in production halls and warehouses, in offices or in administrative and educational facilities – expect much more from a commercial luminaire today. Of course, commercial lights must first and foremost comply with

clearly defined guidelines and standards, for example to ensure safety at the workplace or in public spaces. At the same time, new lighting technologies and findings from various scientific disciplines have greatly expanded the demands placed on commercial luminaires. HCL [Human Centric Lighting] and the absence of glare according to UGR are only two keywords that contribute to the quality of modern lighting solutions. In addition, the aesthetic component also plays an important role: thanks to the triumphant advance of LEDs, manufacturers today have far more scope for design in the development of technical luminaires.



Foto: Daniel Vießer - Architektur fotografie, Karlsruhe

DAS PERFEKTE ARBEITSLICHT...

...depends on various factors and changes depending on the requirements, room and time of day. Basically a commercial luminaire must support the work processes of people whether assembling a car or working on a computer at an working at a computer at an office desk. The same applies for kindergartens, schools and universities – here too the light must support long periods of concentration, without being perceived as a disturbing element. To achieve this, there are various values and key figures, values and indicators, some of which have only come into being thanks to new in the lighting sector. In the following we would like to present some of them to you.

UGR VALUE

The smaller the UGR value, the more glare-free a luminaire emits its light. Especially in office areas, you should use luminaires with a UGR value of less than 19 in order to avoid disturbing reflections. When determining the UGR value of a complete room, additional factors such as wall colour[s] and surface finishes play a role.

COLOUR RENDERING INDEX RA

The colour rendering index Ra describes the measure of the correspondence of the perceived light colour between an existing lighting situation and a reference light source. The smaller the deviation, the better the colour rendering. A light source with Ra 100 reproduces all colours exactly. The lower the Ra value, the less precisely the colours are reproduced.



HCL

HCL stands for "Human Centric Lighting" and means the simulation of lighting situations according to the biological day-night rhythm of humans. HCL matches artificial light indoors to natural daylight and promotes well-being, mood and health. Numerous DEKO-LIGHT luminaires can already be integrated into an HCL control system to adjust the light colours to the biorhythm. In addition, several LED stripes in different light colours can also be combined in one profile and thus integrated into the HCL lighting design.



Foto: Daniel Wieser - Architekturfotografie, Karlsruhe

IK VALUE

Compared to the previous values and key figures, the IK value does not describe the quality of light itself, but indicates how shock- and impact-resistant a luminaire or certain components are. IK00 offers no protection against external mechanical stress, IK 10 or IK10+ means that the luminaire can withstand a 5 or 10 kg test weight from 40 or 50 cm. In addition to the IP protection class, the IK value of a luminaire is increasingly required in tenders and for installation in public spaces.





□ □
page 468



□ □
from page 470



■ □
from page 472



□ □
from page 474



□ □
from page 476



□ □
from page 478



□ □
from page 481



□ □
from page 484



■ □
page 486



□ □
from page 488



□
page 490



□
page 490



□
page 491



□
page 491



□ □ □
from page 492



built in ceiling lights





CETI 5

- aluminium diecast
- dimensions L x W x H: 137 x 60 x 44 mm
- asymmetric beam angle
- dimmable via optional power supply unit

563006 white mat  3000 K 700 lm **109,95 €**



accessories

862049 power supply | 700 mA | 2-19V | 1,4-12,0 W **21,95 €**

862032 power supply dimmable | 700 mA | 9-18V | 6,3-12,0 W **29,95 €**



CETI 10

- aluminium diecast
- dimensions L x W x H: 257 x 60 x 44 mm
- asymmetric beam angle
- dimmable via optional power supply unit

563007 white mat  3000 K 1120 lm **179,95 €**



accessories

862198 power supply | 700 mA | 13-43V | 14,7-30,0 W **25,95 €**

862207 power supply dimmable | 700 mA | 14,0-28,0V | 9,8-20,0 W **42,95 €**

862191 power supply MULTI-CC DALI DALI1/2/Intelli-Push dimmable | 20-36V | 5,0-25,0 W **64,95 €**





CETI 5

- aluminium diecast
- dimensions L x W x H: 137 x 52 x 44 mm
- dimmable via optional power supply unit

565250 white mat, black 3000 K 800 lm **99,95 €**

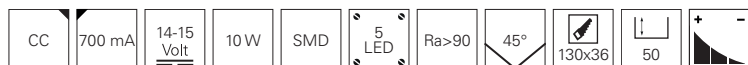

suitable wall lights
page 528
341214

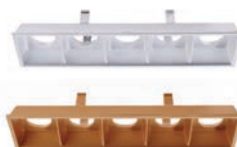

accessories

- 930218** reflector silver coloured **15,95 €**
930215 reflector gold optics **15,95 €**
862049 power supply | 700 mA | 2-19V | 1,4-12,0 W **21,95 €**
862032 power supply dimmable | 700 mA | 9-18V | 6,3-12,0 W **29,95 €**



CETI 10

- aluminium diecast
- dimensions L x W x H: 257 x 52 x 44 mm
- dimmable via optional power supply unit

565251 white mat, black 3000 K 1600 lm **169,95 €**

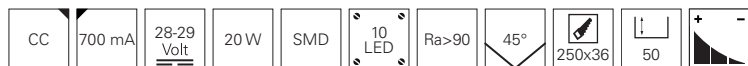

suitable wall lights
page 528
341214



accessories

- 930219** reflector silver coloured **19,95 €**
930216 reflector gold optics **19,95 €**
862198 power supply | 700 mA | 13-43V | 14,7-30,0 W **25,95 €**
862207 power supply dimmable | 700 mA | 14,0-28,0V | 9,8-20,0 W **42,95 €**
862191 power supply MULTI-CC DALI DALI1/2/Intelli-Push dimmable | 20-36V | 5,0-25,0 W **64,95 €**



CETI 15

- aluminium diecast
- dimensions L x W x H: 376 x 52 x 44 mm
- dimmable via optional power supply unit

565252  white mat, black  3000 K 2400 lm **229,95 €**

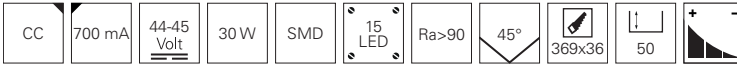

suitable wall
lights
page 528
341214

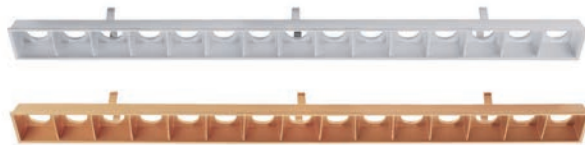

accessories

930220	reflector silver coloured	25,95 €
930217	reflector gold optics	25,95 €
862135	power supply 700 mA 20-57V 14,0-40,0 W	29,95 €
862208	power supply dimmable 700 mA 28-56V 19,6-40,0 W	49,95 €
862192	power supply MULTI-CC DALI1/2/Intelli-Push dimmable 25-64V 17,5-45,0W	69,95 €





CETI 5 HIDE

- aluminium diecast
- dimensions L x W x H: 131 x 56 x 110 mm
- dimmable via optional power supply unit

565253 ■ black ww 3000 K 800 lm **119,95 €**

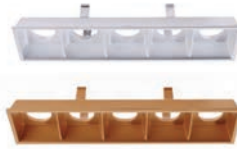
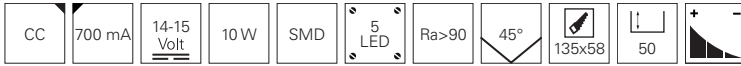

accessories

930218	reflector silver coloured	15,95 €
930215	reflector gold optics	15,95 €
862049	power supply 700 mA 2-19V 1,4-12,0 W	21,95 €
862032	power supply dimmable 700 mA 9-18V 6,3-12,0 W	29,95 €



CETI 10 HIDE

- aluminium diecast
- dimensions L x W x H: 251 x 56 x 110 mm
- dimmable via optional power supply unit

565254 ■ black ww 3000 K 1600 lm **179,95 €**

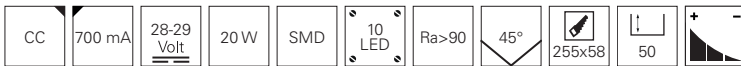

accessories

930219	reflector silver coloured	19,95 €
930216	reflector gold optics	19,95 €
862198	power supply 700 mA 13-43V 14,7-30,0 W	25,95 €
862207	power supply dimmable 700 mA 14,0-28,0V 9,8-20,0 W	42,95 €
862191	power supply MULTI-CC DALI DALI1/2/Intelli-Push dimmable 20-36V 5,0-25,0 W	64,95 €



CETI 15 HIDE

- aluminium diecast
- dimensions L x W x H: 370 x 56 x 110 mm
- dimmable via optional power supply unit

565255 ■ black ww 3000 K 2400 lm **239,95 €**

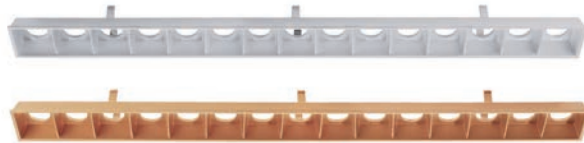
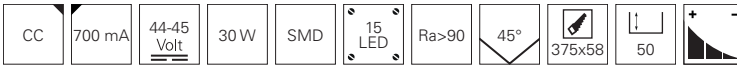

accessories

930220	reflector silver coloured	25,95 €
930217	reflector gold optics	25,95 €
862135	power supply 700 mA 20-57V 14,0-40,0 W	29,95 €
862208	power supply dimmable 700 mA 28-56V 19,6-40,0 W	49,95 €
862192	power supply MULTI-CC DALI1/2/Intelli-Push dimmable 25-64V 17,5-45,0W	69,95 €



CETI 5 ADJUST

- aluminium diecast
- dimensions L x W x H: 155 x 77 x 83 mm
- dimmable via optional power supply unit

565256 white mat, black 3000 K 800 lm **119,95 €**

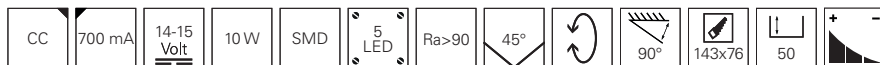

accessories

930218	reflector silver coloured	15,95 €
930215	reflector gold optics	15,95 €
862049	power supply 700 mA 2-19V 1,4-12,0 W	21,95 €
862032	power supply dimmable 700 mA 9-18V 6,3-12,0 W	29,95 €



suitable wall lights
page 528
341214



CETI 10 ADJUST

- aluminium diecast
- dimensions L x W x H: 275 x 83 x 77 mm
- dimmable via optional power supply unit

565257 white mat, black 3000 K 1600 lm **199,95 €**

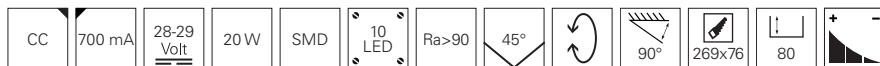

accessories

930219	reflector silver coloured	19,95 €
930216	reflector gold optics	19,95 €
862198	power supply 700 mA 13-43V 14,7-30,0 W	25,95 €
862207	power supply dimmable 700 mA 14,0-28,0V 9,8-20,0 W	42,95 €
862191	power supply MULTI-CC DALI DALI1/2/Intelli-Push dimmable 20-36V 5,0-25,0 W	64,95 €



suitable wall lights
page 528
341214



CETI 15 ADJUST

- aluminium diecast
- dimensions L x W x H: 394 x 77 x 83 mm
- dimmable via optional power supply unit

565258  white mat, black  3000 K 2400 lm **269,95 €**

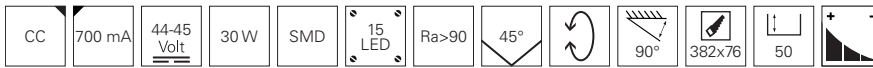

suitable wall lights
page 528
341214

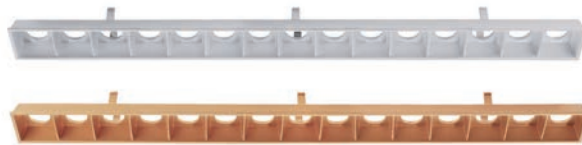

accessories



930220	reflector silver coloured	25,95 €
930217	reflector gold optics	25,95 €
862135	power supply 700 mA 20-57V 14,0-40,0 W	29,95 €
862208	power supply dimmable 700 mA 28-56V 19,6-40,0 W	49,95 €
862192	power supply MULTI-CC DALI1/2/Intelli-Push dimmable 25-64V 17,5-45,0W	69,95 €





COB 95

- aluminium
- dimensions H x Ø: 53 x 110 mm
- dimmable via optional power supply unit
- incl. 2 plastic panes [clear, satined]

565007	<input type="checkbox"/>	Traffic white RAL 9016	 3000 K	1100 lm	69,95 €
565010	<input type="checkbox"/>	Traffic white RAL 9016	 4000 K	1100 lm	69,95 €

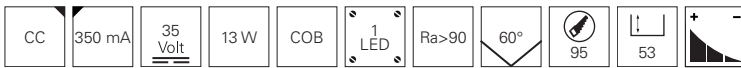



accessories

180512	power supply 350 mA 2-52V 0,7-18,0 W	23,95 €
862204	power supply dimmable 350 mA 28-57V 9,8-20,0 W	39,95 €
862191	power supply MULTI-CC DALI1/2/Intelli-Push dimmable 20-60V 7,0-20,0 W	64,95 €



COB 130

- aluminium
- dimensions H x Ø: 69 x 145 mm
- dimmable via optional power supply unit
- incl. 2 plastic panes [clear, satined]

565180	<input type="checkbox"/>	Traffic white RAL 9016	 3000 K	1360 lm	89,95 €
565181	<input type="checkbox"/>	Traffic white RAL 9016	 4000 K	1451 lm	89,95 €

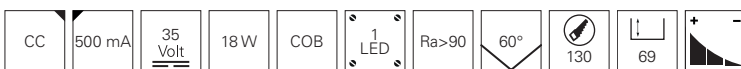

accessories

872665	power supply dimmable 500 mA 20-60V 10,0-30,0 W	25,95 €
862205	power supply dimmable 500 mA 20-40V 10,0-20,0 W	42,95 €
862191	power supply MULTI-CC DALI1/2/Intelli-Push dimmable 20-50V 10,0-25,0 W	64,95 €



COB 170

- aluminium
- dimensions H x Ø: 86 x 190 mm
- dimmable via optional power supply unit
- incl. 2 plastic panes [clear, satined]

565182	<input type="checkbox"/>	Traffic white RAL 9016	ww	3000 K	2100 lm	119,95 €
565183	<input type="checkbox"/>	Traffic white RAL 9016	nw	4000 K	2100 lm	119,95 €

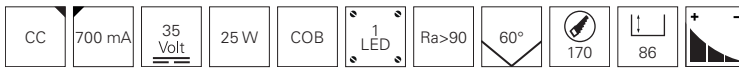

accessories

862198	power supply 700 mA 21-43V 14,7-30,0 W	25,95 €
862208	power supply dimmable 700 mA 28-56V 19,6-40,0 W	49,95 €
862192	power supply MULTI-CC DALI1/2/Intelli-Push dimmable 25-64V 17,5-45,0 W	69,95 €



COB 210

- aluminium
- dimensions H x Ø: 99 x 230 mm
- dimmable via optional power supply unit
- incl. 2 plastic panes [clear, satined]

565184	<input type="checkbox"/>	Traffic white RAL 9016	ww	3000 K	3000 lm	152,95 €
565185	<input type="checkbox"/>	Traffic white RAL 9016	nw	4000 K	3200 lm	152,95 €

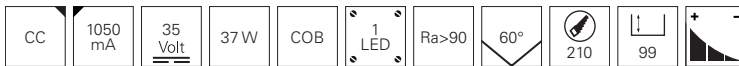

accessories

862198	power supply 700 mA 21-43V 14,7-30,0 W	25,95 €
862208	power supply dimmable 700 mA 28-56V 19,6-40,0 W	49,95 €
862192	power supply MULTI-CC DALI1/2/Intelli-Push dimmable 25-64V 17,5-45,0 W	69,95 €
862201	power supply 1050 mA 19-38V 20,0-40,0 W	29,95 €
862209	power supply dimmable 1050 mA 19-38V 20,0-40,0 W	49,95 €
862193	power supply MULTI-CC DALI1/2/Intelli-Push dimmable 14-43V 14,7-45,0 W	69,95 €



LED PANEL ROUND III 6

- aluminium diecast
- dimensions H x Ø: 34 x 106 mm
- dimmable via optional power supply unit

565229	<input type="checkbox"/>	Traffic white RAL 9016	ww	3000 K	620 lm	61,95 €
565230	<input type="checkbox"/>	Traffic white RAL 9016	nw	4000 K	630 lm	61,95 €

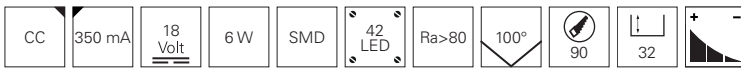

accessories

872631	power supply 350 mA 2-35V 0,7-12,0 W	21,95 €
862202	power supply dimmable 350 mA 11-26V 3,9-9,0 W	28,95 €
862190	power supply MULTI-CC DALI1/2/Intelli-Push dimmable 15-34V 5,2-12,0 W	59,95 €



LED PANEL ROUND III 12

- aluminium diecast
- dimensions H x Ø: 36 x 140 mm
- dimmable via optional power supply unit

565231	<input type="checkbox"/>	Traffic white RAL 9016	ww	3000 K	1310 lm	81,95 €
565232	<input type="checkbox"/>	Traffic white RAL 9016	nw	4000 K	1320 lm	81,95 €

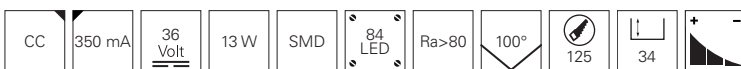

accessories

180512	power supply 350 mA 2-52V 0,7-18,0 W	23,95 €
862204	power supply dimmable 350 mA 28-57V 9,8-20,0 W	39,95 €
862191	power supply MULTI-CC DALI DALI1/2/Intelli-Push dimmable 20-60V 7,0-20,0 W	64,95 €



LED PANEL ROUND III 20

- aluminium diecast
- dimensions H x Ø: 38 x 180 mm
- dimmable via optional power supply unit

565233	<input type="checkbox"/>	Traffic white RAL 9016	ww	3000 K	1980 lm	102,95 €
565234	<input type="checkbox"/>	Traffic white RAL 9016	nw	4000 K	1970 lm	102,95 €

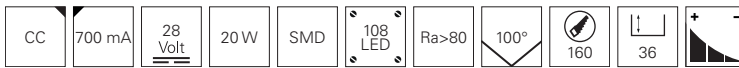

accessories

862198	power supply 700 mA 21-43V 14,7-30,0 W	25,95 €
862207	power supply dimmable 700 mA 14,0-28,0V 9,8-20,0 W	42,95 €
862191	power supply MULTI-CC DALI DALI1/2/Intelli-Push dimmable 20-36V 14,0-25,0 W	64,95 €



LED PANEL ROUND III 26

- aluminium diecast
- dimensions H x Ø: 38 x 230 mm
- dimmable via optional power supply unit

565235	<input type="checkbox"/>	Traffic white RAL 9016	ww	3000 K	2680 lm	123,95 €
565236	<input type="checkbox"/>	Traffic white RAL 9016	nw	4000 K	2690 lm	123,95 €

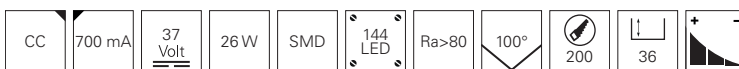

accessories

862198	power supply 700 mA 21-43V 14,7-30,0 W	25,95 €
862208	power supply dimmable 700 mA 28-56V 19,6-40,0 W	49,95 €
862192	power supply MULTI-CC DALI1/2/Intelli-Push dimmable 25-64V 17,5-45,0 W	69,95 €



Foto: Daniel Vießer . Architekturfotografie, Karlsruhe

ACRUX

All luminaires in the ACRUX series have a special feature; the light temperature [3000, 4000, 6000 K] can be set before installation with the switch on the back. This allows a lot of flexibility in the planning phase. The luminous intensity can be individually regulated by phase angle control. The cover supplied can be easily removed if necessary so that the luminaire can also be installed in its housing colour [white]. The integrated diffuser reduces glare and creates a pleasant lighting situation.



incl. cover
silver coloured brushed, black



switch for setting
the light temperature



3000 K



4000 K



6000 K



ACRUX 68

- plastic
- dimensions H x Ø: 57,5 x 95,0 mm
- leading or trailing edge
- light colour adjustable via dip switch [CCT DIP]

565315 Traffic white RAL 9016 mat WW NW CW 3000/4000/6000 K 630 lm **25,95 €**

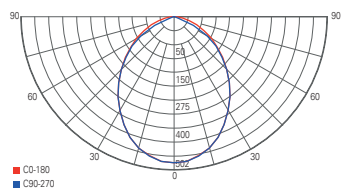
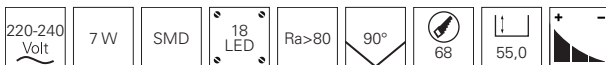

light distribution curve



ACRUX 90

- plastic
- dimensions H x Ø: 58,0 x 113,0 mm
- leading or trailing edge
- light colour adjustable via dip switch [CCT DIP]

565316 Traffic white RAL 9016 mat WW NW CW 3000/4000/6000 K 760 lm **30,95 €**

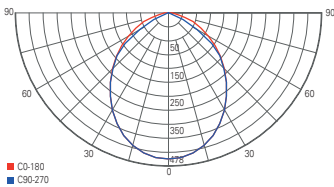
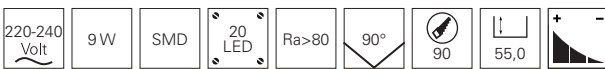

light distribution curve



ACRUX 120

- plastic
- dimensions H x Ø: 65,8 x 145,0 mm
- leading or trailing edge
- light colour adjustable via dip switch [CCT DIP]

565317 Traffic white RAL 9016 mat WW NW CW 3000/4000/6000 K 1370 lm **36,95 €**

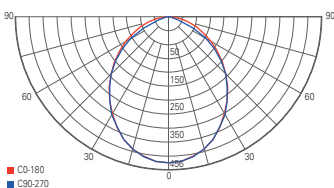
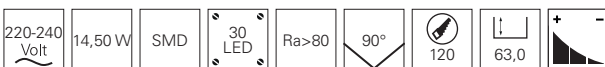

light distribution curve



ACRUX 145

- plastic
- dimensions H x Ø: 68,5 x 174,0 mm
- leading or trailing edge
- light colour adjustable via dip switch [CCT DIP]

565318 Traffic white RAL 9016 mat ww nw cw 3000/4000/6000 K 1570 lm **41,95 €**

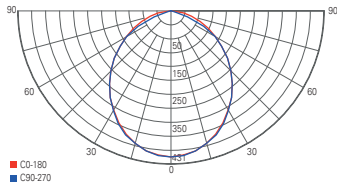
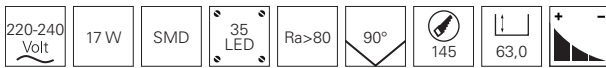

light distribution curve



ACRUX 195

- plastic
- dimensions H x Ø: 84,0 x 244,0 mm
- leading or trailing edge
- light colour adjustable via dip switch [CCT DIP]

565332 Traffic white RAL 9016 mat ww nw cw 3000/4000/6000 K 2670 lm **51,95 €**

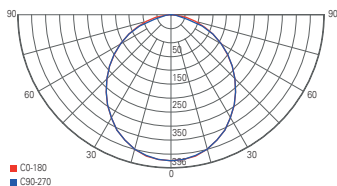
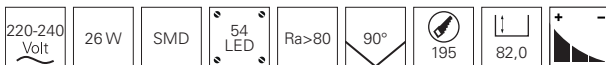

light distribution curve

ZAURAK

Recessed ceiling luminaires can be discreetly integrated into private and commercial spaces, but when they need to be replaced, the existing ceiling cut-out can become a problem. The ZAURAK series comes with an adjustable mounting bracket that allows larger or smaller ceiling cut-outs to be used. In addition, the ZAURAK has a low installation depth for universal use. The scope of delivery includes two interchangeable cover rings in silver and black.



ZAURAK 180

- light colour and output adjustable via dip switch [CCT / W DIP]
- incl. cover [silver coloured and black]
- cut-out size: 65-160 mm
- plastic
- dimensions H x Ø: 21 x 180 mm

565327 white WW NW CW 3000/4000/5700 K 1060 lm **39,95 €**

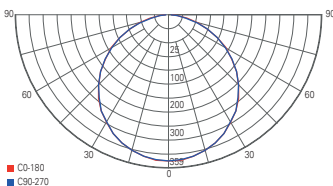

light distribution curve



ZAURAK 220

- light colour and output adjustable via dip switch [CCT / W DIP]
- incl. cover [silver coloured and black]
- cut-out size: 120-200 mm
- plastic
- dimensions H x Ø: 22 x 220 mm

565328 white WW NW CW 3000/4000/5700 K 1750 lm **49,95 €**

220-240 Volt	12/18 W	SMD	65 LED	Ra>80	110°	120	IP44
--------------	---------	-----	--------	-------	------	-----	------

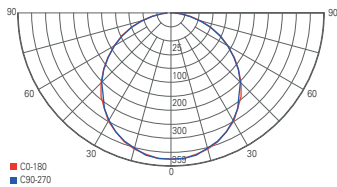

light distribution curve



ZAURAK 300

- light colour and output adjustable via dip switch [CCT / W DIP]
- incl. cover [silver coloured and black]
- cut-out size: 150-270 mm
- plastic
- dimensions H x Ø: 25 x 300 mm

565329 white WW NW CW 3000/4000/5700 K 2420 lm **69,95 €**

220-240 Volt	18/25 W	SMD	91 LED	Ra>80	110°	150	IP44
--------------	---------	-----	--------	-------	------	-----	------

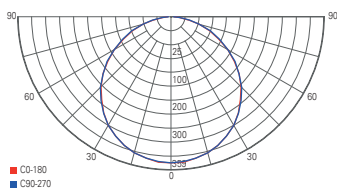

light distribution curve

MODULAR SYSTEM COB

The MODULAR family of recessed ceiling luminaires offers a wide range of applications. Whether almost invisible or with a present frame – these modules are as flexible as you want them to be. By exchanging the reflectors, different light cones can be created and by using filters / diffusers, you can individually select or retrofit your lighting mood. We offer the LED modules in warm and neutral white. This gives you the option of adapting the individual elements to local requirements in order to create your perfect lighting situation.



MODULAR SYSTEM COB 26/33W

- aluminium diecast
- dimensions H x Ø: 116 x 93 mm
- dimmable via optional power supply unit

565333	■	Signal black RAL9004	ww	3000 K	3200 lm	99,95 €
565334	■	Signal black RAL9004	nw	4000 K	3500 lm	99,95 €

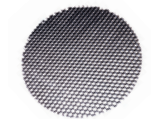
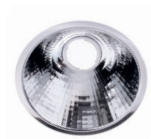

accessories

930084	reflector 17°	9,95 €
930085	reflector 40°	9,95 €
930087	diffusor gefrostet	0,95 €
930088	honeycomb filter	4,95 €
862157	power supply basic 900 mA 22-44V 19,8-40,0 W	29,95 €
862192	power supply MULTI-CC DALI1/2/Intelli-Push dimmable 25-50V 22,5-45,0 W	69,95 €



accessories built-in ring fixed

930089 white mat
H x Ø: 50 x 170 mm
cut-out size Ø: 150 mm **18,95 €**

930090 white mat
H x Ø: 80 x 230 mm
cut-out size Ø: 220 mm **25,95 €**



accessories built-in ring transversable

930091 white mat
H x Ø: 30 x 130 mm
cut-out size: 115 mm **28,95 €**



accessories gimbal frame transversable

930092 1er gimbal frame | white mat
L x W x H: 140 x 140 x 43 mm
cut-out size: 130 x 130 mm **30,95 €**

930093 2er gimbal frame | white mat
L x W x H: 257 x 140 x 43 mm
cut-out size: 240 x 130 mm **56,95 €**



accessories gimbal frame transversable | without frame

930094 1er gimbal frame | white mat
L x W x H: 178 x 120 x 50 mm
cut-out size: 120 x 120 mm **72,95 €**

930095 1er gimbal frame | black mat
L x W x H: 178 x 120 x 50 mm
cut-out size: 120 x 120 mm **72,95 €**

930096 2er gimbal frame | white mat
L x W x H: 305 x 120 x 50 mm
cut-out size: 247 x 120 mm **92,95 €**

930097 2er gimbal frame | black mat
L x W x H: 305 x 120 x 50 mm
cut-out size: 247 x 120 mm **92,95 €**

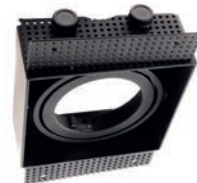



UNI II

- aluminium diecast
- dimensions H x Ø: 84 x 139 mm
- dimmable via optional power supply unit

565343 Signal white RAL 9003 3000 K 1035 lm

109,95 €

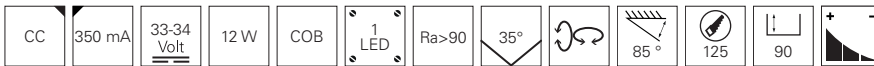

accessories

930339	reflector ring black	9,95 €
930340	reflector ring gold	9,95 €
930341	reflector ring chrom	9,95 €
930371	reflector ring II black	9,95 €
930337	cover heatsink black	2,95 €
930306	reflector 50°	9,95 €
930307	honeycomb filter	9,95 €
930308	spread lens 40° clear/satined	9,95 €
930309	softening lens 47° satined	9,95 €
930310	linear spread lens 40°/80° asymmetric clear/satined	9,95 €
180512	power supply 350 mA 2-52V 0,7-18,0 W	23,95 €
862204	power supply dimmable 350 mA 28-57V 9,8-20,0 W	39,95 €
862191	power supply MULTI-CC DALI DALI1/2/Intelli-Push dimmable 20-60V 7,0-20,0 W	64,95 €



UNI II MINI

- aluminium diecast
- dimensions H x Ø: 80 x 103 mm
- dimmable via optional power supply unit

565342 Signal white RAL 9003  3000 K 670 lm **89,95 €**

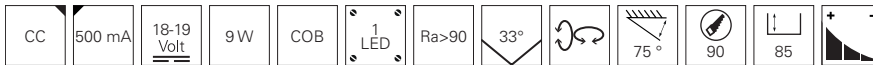

accessories

930331	reflector ring black	9,95 €
930332	reflector ring gold	9,95 €
930333	reflector ring chrom	9,95 €
930381	reflector ring II black	9,95 €
930329	cover heatsink black	2,95 €
180513	power supply 500 mA 2-38V 1,0-18,0 W	23,95 €
862030	power supply dimmable 500 mA 12-24V 6,0-12,0 W	29,95 €
862190	power supply MULTI-CC DALI1/2/Intelli-Push dimmable 15-24V 7,5-12,0 W	59,95 €



UNI II MAX

- aluminium diecast
- dimensions H x Ø: 97 x 165 mm
- dimmable via optional power supply unit

565344 Signal white RAL 9003  3000 K 2150 lm **129,95 €**

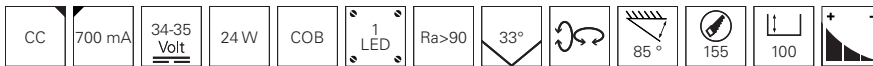

accessories

930398	reflector ring black	9,95 €
930399	reflector ring gold	9,95 €
930382	reflector ring II black	9,95 €
930396	cover heatsink black	3,95 €
930390	reflector 24°	9,95 €
930392	reflector 50°	9,95 €
862198	power supply 700 mA 21-43V 14,7-30,0 W	25,95 €
862208	power supply dimmable 700 mA 28-56V 19,6-40,0 W	49,95 €
862192	power supply MULTI-CC DALI1/2/Intelli-Push dimmable 25-64V 17,5-45,0 W	69,95 €



ALYA

- **LED driver integrated in housing**

- plastic
- dimensions H x Ø: 10 x 120 mm
- dimmable via leading or trailing edge

565320 Traffic white RAL 9016  2700 K 540 lm **19,95 €**

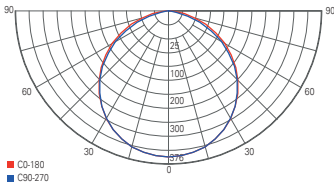
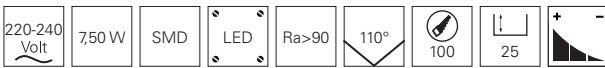

light distribution curve



ALYA

- **LED driver integrated in housing**

- plastic
- dimensions L x W x H: 120 x 120 x 10 mm
- dimmable via leading or trailing edge

565321 Traffic white RAL 9016  2700 K 820 lm **22,95 €**

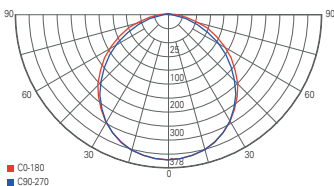
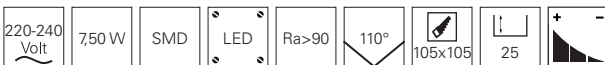

light distribution curve



ALYA

- LED driver integrated in housing
- plastic
- dimensions H x Ø: 10 x 180 mm
- dimmable via leading or trailing edge

565322 Traffic white RAL 9016 ww 2700 K 960 lm **26,95 €**

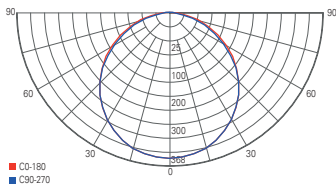
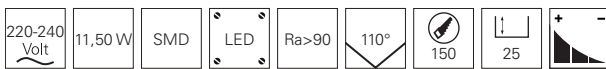

light distribution curve



ALYA

- LED driver integrated in housing
- plastic
- dimensions L x W x H: 180 x 180 x 10 mm
- dimmable via leading or trailing edge

565323 Traffic white RAL 9016 ww 2700 K 960 lm **28,95 €**

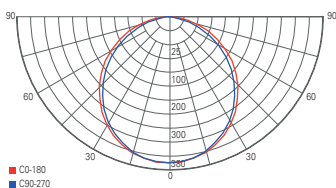
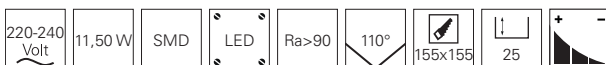

light distribution curve



LED PANEL SQUARE 8

- aluminium diecast
- dimensions L x W x H: 110 x 110 x 23,5 mm
- dimmable via optional power supply unit

565152	<input type="checkbox"/>	Signal white RAL 9003	<input type="checkbox"/>	2700 K	560 lm	34,95 €
565153	<input type="checkbox"/>	Pearl light grey RAL 9022	<input type="checkbox"/>	2700 K	560 lm	34,95 €
565154	<input type="checkbox"/>	Signal white RAL 9003	<input type="checkbox"/>	4000 K	560 lm	34,95 €
565155	<input type="checkbox"/>	Pearl light grey RAL 9022	<input type="checkbox"/>	4000 K	560 lm	34,95 €

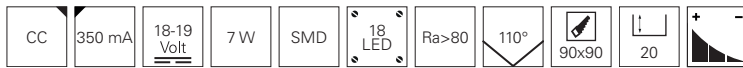

accessories

872631	power supply 350 mA 2-35V 0,7-12,0 W	21,95 €
862202	power supply dimmable 350 mA 11-26V 3,9-9,0 W	28,95 €
862190	power supply MULTI-CC DALI1/2/Intelli-Push dimmable 15-34V 4,2-12,0 W	59,95 €



LED PANEL SQUARE 15

- aluminium diecast
- dimensions L x W x H: 180 x 180 x 21 mm
- dimmable via optional power supply unit

565156	<input type="checkbox"/>	Signal white RAL 9003	<input type="checkbox"/>	2700 K	1000 lm	49,95 €
565157	<input type="checkbox"/>	Pearl light grey RAL 9022	<input type="checkbox"/>	2700 K	1000 lm	49,95 €
565158	<input type="checkbox"/>	Signal white RAL 9003	<input type="checkbox"/>	4000 K	1130 lm	49,95 €
565159	<input type="checkbox"/>	Pearl light grey RAL 9022	<input type="checkbox"/>	4000 K	1130 lm	49,95 €

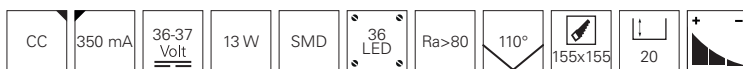

accessories

180512	power supply 350 mA 2-52V 0,7-18,0 W	23,95 €
862204	power supply dimmable 350 mA 28-57V 9,8-20,0 W	39,95 €
862191	power supply MULTI-CC DALI1/2/Intelli-Push dimmable 20-60V / 7,0-20,0 W	64,95 €



LED PANEL SQUARE 20

- aluminium diecast
- dimensions L x W x H: 237 x 237 x 20 mm
- dimmable via optional power supply unit

565160	<input type="checkbox"/>	Signal white RAL 9003	<input checked="" type="checkbox"/>	2700 K	1560 lm	69,95 €
565161	<input type="checkbox"/>	Pearl light grey RAL 9022	<input checked="" type="checkbox"/>	2700 K	1560 lm	69,95 €
565162	<input type="checkbox"/>	Signal white RAL 9003	<input checked="" type="checkbox"/>	4000 K	1740 lm	69,95 €
565163	<input type="checkbox"/>	Pearl light grey RAL 9022	<input checked="" type="checkbox"/>	4000 K	1740 lm	69,95 €

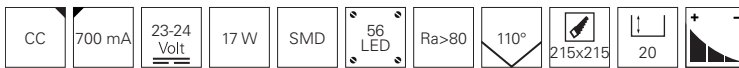

accessories

180514	power supply 700 mA 2-26V 1,4-18,0 W	23,95 €
862207	power supply dimmable 700 mA 14-28V 9,8-20,0 W	42,95 €
862191	power supply MULTI-CC DALI1/2/Intelli-Push dimmable 20-36V 14,0-25,0 W	64,95 €





page 497



page 498



page 499



page 500



page 501



page 502



page 504



page 505



page 506



page 507



page 509



page 510



page 511



page 512



page 512



page 512



page 513



page 513



page 513



page 514



page 514



page 514



page 515



page 515

insert panels



With the kind support of Regionaldirektion für Deutsche Vermögensberatung Pierre Werner / Direktion für Deutsche Vermögensberatung Uwe Liebholz

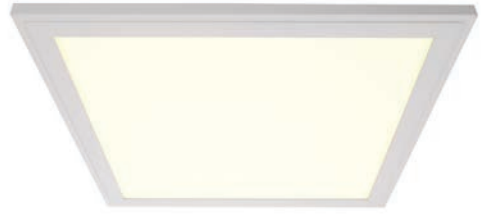

LED PANEL 3K SMALL

- aluminium
- dimensions L x W x H: 295 x 295 x 10 mm
- dimmable via optional power supply unit
- incl. 50 cm connection cable

565220	<input type="checkbox"/>	Traffic white RAL 9016	<input type="checkbox"/>	3000 K	2500 lm	69,95 €
565221	<input type="checkbox"/>	Traffic white RAL 9016	<input type="checkbox"/>	4000 K	2500 lm	69,95 €



accessories

930230	insert frame 30 x 30	25,95 €
930167	surface mounting frame 30 x 30	25,95 €
862198	power supply 700 mA 21-43V 14,7-30,0 W	25,95 €
862208	power supply dimmable 700 mA 28-56V 19,6-40,0 W	49,95 €
862192	power supply MULTI-CC DALI1/2/Intelli-Push dimmable 25-64V 17,5-45,0 W	69,95 €

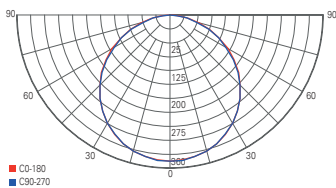

light distribution curve 565220

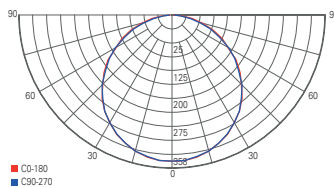

light distribution curve 565221



LED PANEL FLEX

- aluminium
- dimensions L x W x H: 620 x 620 x 10 mm
- UGR <19
- dimmable via leading or trailing edge
- light color adjustable via dip switch [CCT DIP]

100058 Traffic white RAL 9016 WW CW NW 3000/4000/5500 K 3300 lm **139,95 €**

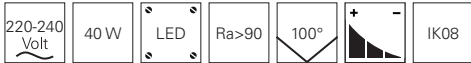

accessories

930232 insert frame | 62 x 62 **36,95 €**

930179 surface mounting frame | 62 x 62 **36,95 €**

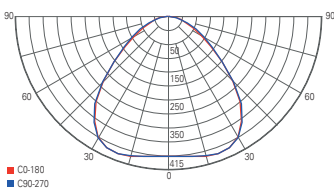
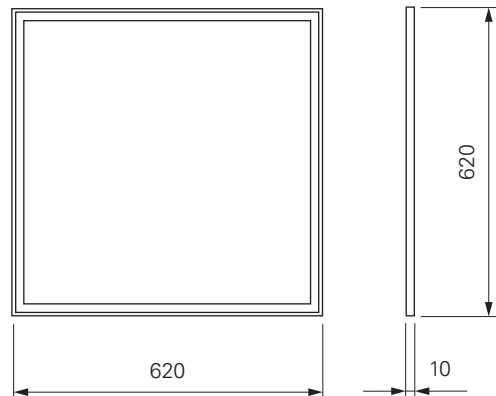

light distribution curve 100058



LED PANEL FLEX

- aluminium
- dimensions L x W x H: 1195 x 295 x 10 mm
- UGR <19
- dimmable via leading or trailing edge
- light color adjustable via dip switch [CCT DIP]

100059 Traffic white RAL 9016 WW CW NW 3000/4000/5500 K 3500 lm **174,95 €**

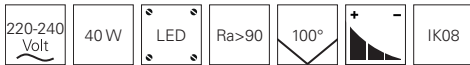

accessories

930233 insert frame | 120 x 30 **49,95 €**

930152 surface mounting frame | 120 x 30 **51,95 €**

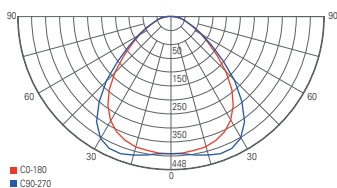
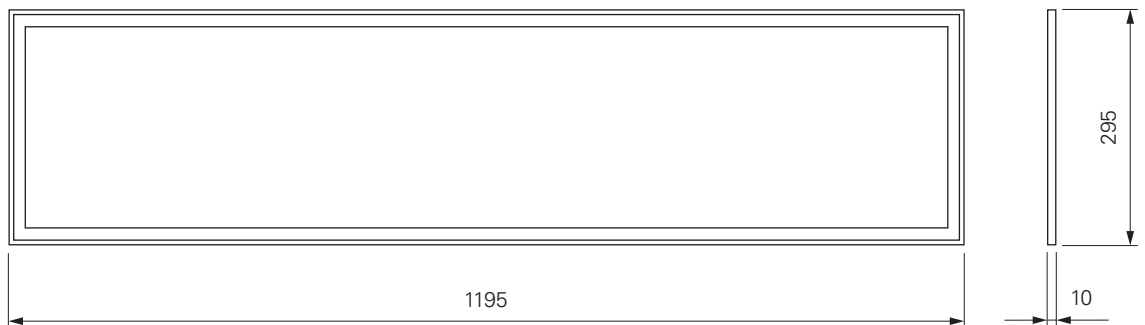

light distribution curve 100059



LED PANEL PRO

- aluminium
- dimensions L x W x H: 620 x 620 x 10 mm
- dimmable via optional power supply unit

100043	<input type="checkbox"/>	Traffic white RAL 9016	<input type="checkbox"/>	ww	3000 K	3300 lm	99,95 €
100044	<input type="checkbox"/>	Traffic white RAL 9016	<input type="checkbox"/>	nw	4000 K	3400 lm	99,95 €
100045	<input type="checkbox"/>	Traffic white RAL 9016	<input type="checkbox"/>	cw	6000 K	3400 lm	99,95 €



accessories

930232	insert frame 62 x 62	36,95 €
930179	surface mounting frame 62 x 62	36,95 €
862201	power supply 1050 mA 19-38V 20,0-40,0 W	29,95 €
862209	power supply dimmable 1050 mA 19-38V 20,0-40,0 W	49,95 €
862192	power supply MULTI-CC DALI1/2/Intelli-Push dimmable 21-43V 25,0-45,0 W	69,95 €

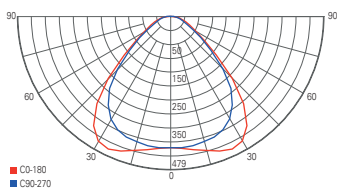
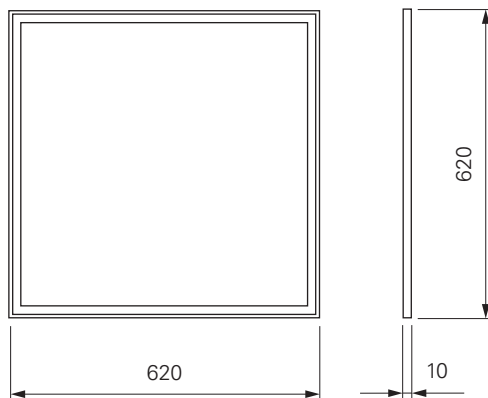

light distribution curve 100043

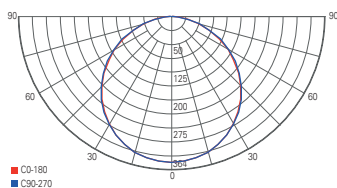

light distribution curve 100044

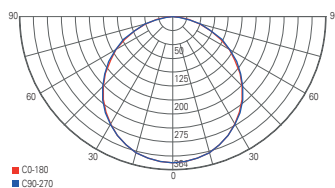

light distribution curve 100045



LED PANEL PRO OFFICE

- aluminium
- dimensions L x W x H: 620 x 620 x 10 mm
- dimmable via optional power supply unit

100046 Traffic white RAL 9016 NW 4000 K 3500 lm **104,95 €**



accessories

930232	insert frame 62 x 62	36,95 €
930179	surface mounting frame 62 x 62	36,95 €
862201	power supply 1050 mA 19-38V 20,0-40,0 W	29,95 €
862209	power supply dimmable 1050 mA 19-38V 20,0-40,0 W	49,95 €
862192	power supply MULTI-CC DALI1/2/Intelli-Push dimmable 21-43V 25,0-45,0 W	69,95 €

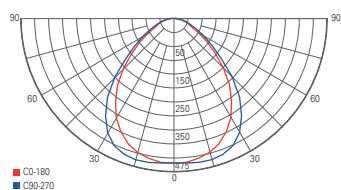
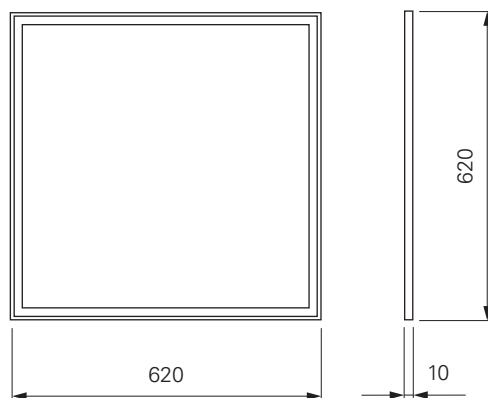

light distribution curve 100046



LED PANEL PRO

- aluminium
- dimensions L x W x H: 595 x 595 x 10 mm
- dimmable via optional power supply unit

100069	<input type="checkbox"/> weiß	<input checked="" type="checkbox"/> ww	3000 K	3300 lm	99,95 €
100071	<input type="checkbox"/> weiß	<input checked="" type="checkbox"/> nw	4000 K	3400 lm	99,95 €



accessories

930231	insert frame 60 x 60	36,95 €
930168	surface mounting frame 60 x 60	36,95 €
862201	power supply 1050 mA 19-38V 20,0-40,0 W	29,95 €
862209	power supply dimmable 1050 mA 19-38V 20,0-40,0 W	49,95 €
862192	power supply MULTI-CC DALI1/2/Intelli-Push dimmable 21-43V 25,0-45,0 W	69,95 €

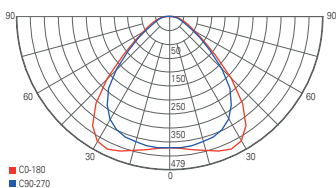
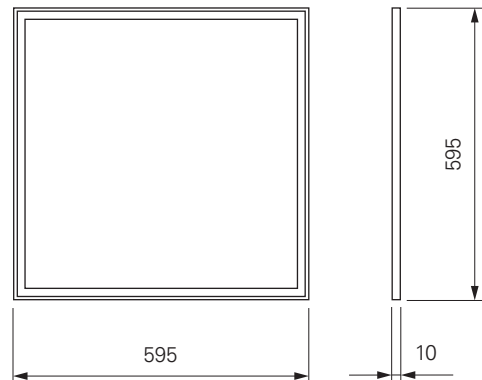

light distribution curve 100069

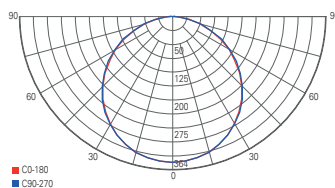

light distribution curve 100071





LED PANEL PRO

- aluminium
- dimensions L x W x H: 1195 x 295x 10 mm
- dimmable via optional power supply unit
- incl. suspension ropes max. 1500 mm

100047	<input type="checkbox"/>	Traffic white RAL 9016	ww	3000 K	3460 lm	109,95 €
100051	<input type="checkbox"/>	Traffic white RAL 9016	nw	4000 K	3400 lm	109,95 €



accessories

930233	insert frame 120 x 30	49,95 €
930152	surface mounting frame 120 x 30	51,95 €
862201	power supply 1050 mA 19-38V 20,0-40,0 W	29,95 €
862209	power supply dimmable 1050 mA 19-38V 20,0-40,0 W	49,95 €
862192	power supply MULTI-CC DALI1/2/Intelli-Push dimmable 21-43V 25,0-45,0 W	69,95 €

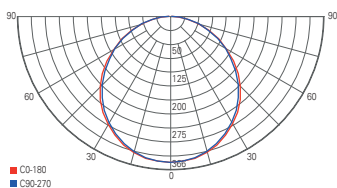
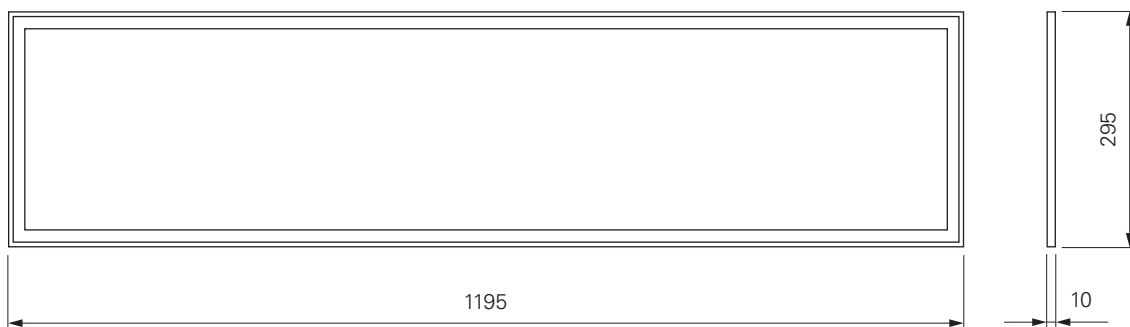

light distribution curve 100047

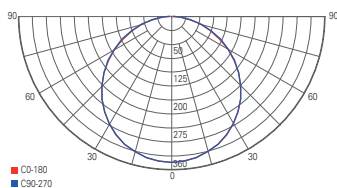

light distribution curve 100051

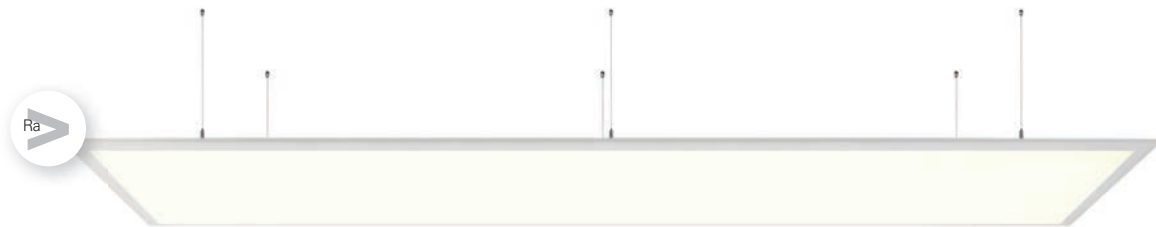

LED PANEL PRO

- aluminium
- dimensions L x W x H: 1240 x 620 x 11 mm
- dimmable via optional power supply unit
- incl. suspension ropes max. 1500 mm

100056	<input type="checkbox"/>	Traffic white RAL 9016	<input checked="" type="checkbox"/>	3000 K	4700 lm	189,95 €
100057	<input type="checkbox"/>	Traffic white RAL 9016	<input checked="" type="checkbox"/>	4000 K	4800 lm	189,95 €



accessories

930234	insert frame 124 x 62	59,95 €
930180	surface mounting frame 124 x 62	61,95 €
862211	power supply dimmable 1300 mA 20-39V 26,0-50,0 W	61,95 €
862194	power supply MULTI-CC DALI1/2/Intelli-Push dimmable 25-58V 32,5-75,5 W	64,95 €

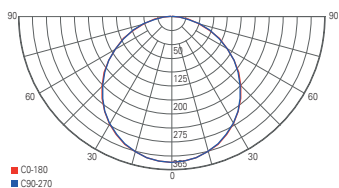

light distribution curve 100056

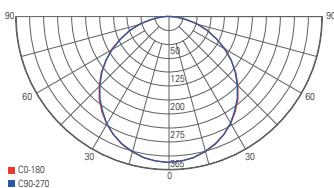

light distribution curve 100057



CCT WW/CW

- aluminium
- dimensions L x W x H: 620 x 620 x 10 mm
- dimmable via optional controller

100032 Traffic white RAL 9016 ww cw 3000-5500 K 3551 lm **139,95 €**

CV	24 Volt	48 W	SMD	480 LED	Ra>80	120 °	
----	---------	------	-----	---------	-------	-------	--

accessories

930232	insert frame 62 x 62	36,95 €
930179	surface mounting frame 62 x 62	36,95 €
862122	power supply 24V DC 50 W	54,95 €
862166	power supply 24V DC 100 W	94,95 €
843057	RF controller set white 12/24/48V	99,95 €

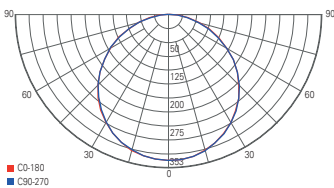
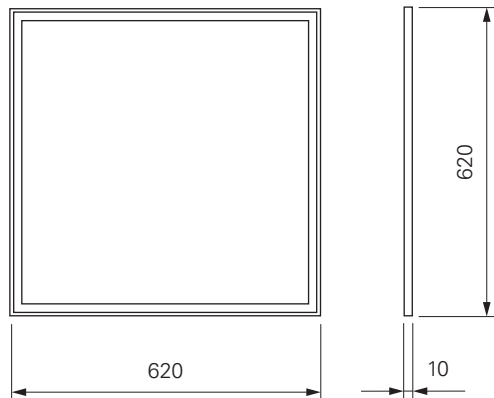

light distribution curve 100032



LED PANEL RGBW

- aluminium
- dimensions L x W x H: 620 x 620 x 14 mm
- dimmable via optional controller

100035 Traffic white RAL 9016  4000 K 3330 lm **149,95 €**



accessories

930232	insert frame 62 x 62	36,95 €
930179	surface mounting frame 62 x 62	36,95 €
862164	power supply 24V DC 75 W	69,95 €
862168	power supply 24V DC 150 W	129,95 €
843059	RF controller set RGB+white 12/24/48V	109,95 €

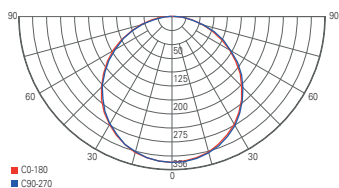
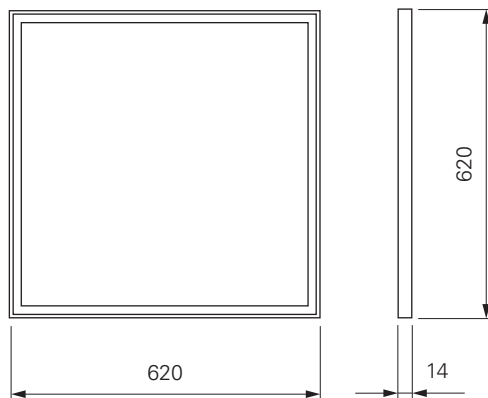

light distribution curve 100035



LED PANEL

The multifunctional office panels are real all-rounders. In combination with modern control systems, the possibilities go far beyond UGR-compliant illumination of office areas. Automatically adjust the light colour to the time of day with the CCT panel [HCL] or benefit from the RGB+W variant for atmospheric after-work lighting.



LED PANEL OFFICE CCT WHITE

- aluminium
- dimensions L x W x H: 1195 x 295 x 10 mm
- dimmable via optional controller

100072 Traffic white RAL 9016 WW NW 3000-4000 K 6655 lm **184,95 €**

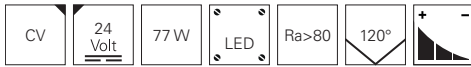

accessories

930588	canopy with wire suspension	38,95 €
862166	power supply basic 24V DC 100 W	94,95 €
872089	power supply IP 24V DC 240 W	179,95 €
843057	RF controller set white 12/24/48V	99,95 €

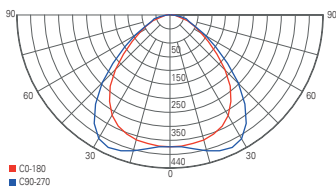
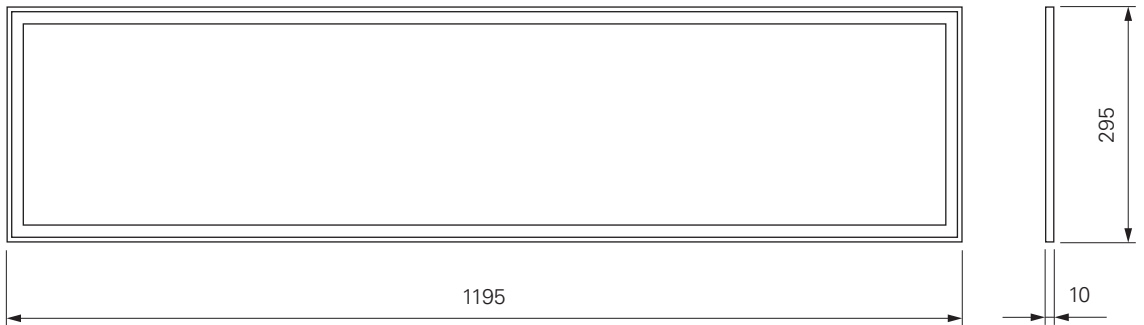

light distribution curve 100072



LED PANEL RGBNW WHITE

- aluminium
- dimensions L x W x H: 1195 x 295 x 14 mm
- dimmable via optional controller

100076 Traffic white RAL 9016  4000 K 3540 lm **189,95 €**

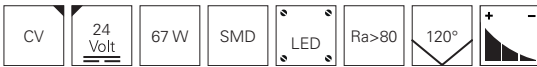

accessories

930152	surface mounting frame 120 x 30	51,95 €
930233	insert frame 120 x 30	49,95 €
930588	canopy with wire suspension	38,95 €
862164	power supply 24V DC 75 W	74,95 €
862168	power supply 24V DC 150 W	129,95 €
843059	RF controller set RGB+white 12/24/48V	109,95 €

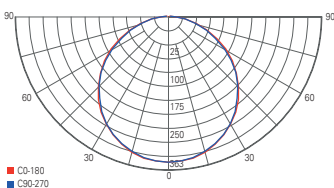
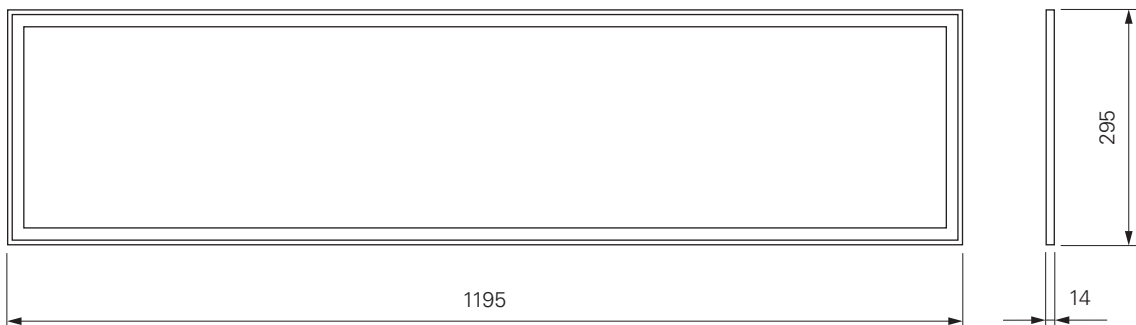

light distribution curve 100076



LED PANEL RGBNW BLACK

- aluminium
- dimensions L x W x H: 1195 x 295 x 14 mm
- dimmable via optional controller

100073 ■ black RGB NW 4000 K 3540 lm **189,95 €**



accessories

930152	surface mounting frame 120 x 30	51,95 €
930233	insert frame 120 x 30	49,95 €
930588	canopy with wire suspension	38,95 €
862164	power supply 24V DC 75 W	74,95 €
862168	power supply 24V DC 150 W	129,95 €
843059	RF controller set RGB+white 12/24/48V	109,95 €

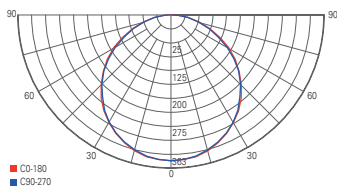
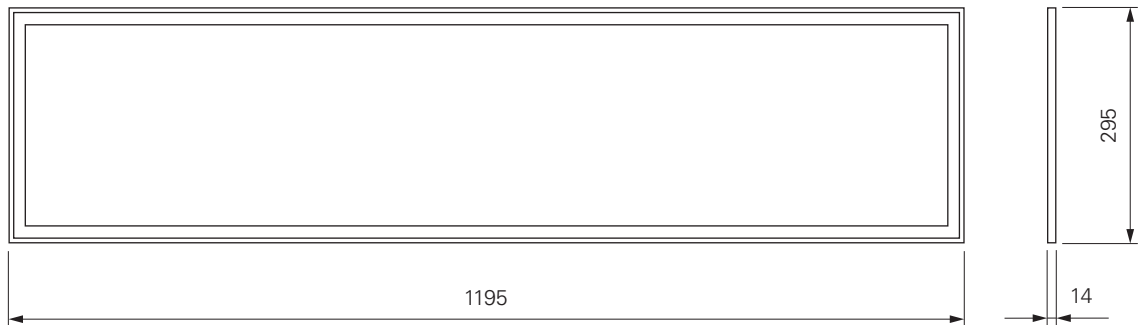

light distribution curve 100073

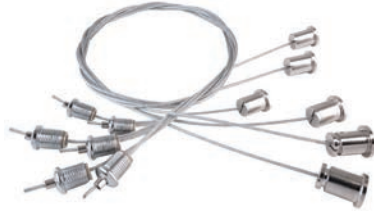

WIRE SUSPENSION LED PANEL

- metal
- max. suspension: 1500 mm

930342	<input type="checkbox"/>	silver coloured 4-piece	12,95 €
930153	<input type="checkbox"/>	silver coloured 6-piece	14,95 €



SURFACE MOUNTING FRAME 30X30

- aluminium extruded profil
- dimensions L x W x H: 303 x 303 x 50 mm
- incl. mounting material

930167	<input type="checkbox"/>	Traffic white RAL 9016	25,95 €
---------------	--------------------------	------------------------	----------------



SURFACE MOUNTING FRAME 60X60

- aluminium extruded profil
- dimensions L x W x H: 603 x 603 x 50 mm
- incl. mounting material

930168	<input type="checkbox"/>	Traffic white RAL 9016	36,95 €
---------------	--------------------------	------------------------	----------------



SURFACE MOUNTING FRAME 62X62

- aluminium extruded profil
- dimensions L x W x H: 628 x 628 x 50 mm
- incl. mounting material

930179 Traffic white RAL 9016 **36,95 €**



SURFACE MOUNTING FRAME 120X30

- aluminium extruded profil
- dimensions L x W x H: 1201 x 301 x 50 mm
- incl. mounting material

930152 Traffic white RAL 9016 **51,95 €**



SURFACE MOUNTING FRAME 124X62

- aluminium extruded profil
- dimensions L x W x H: 1246 x 626 x 50 mm
- incl. mounting material

930180 Traffic white RAL 9016 **61,95 €**



INSERT FRAME FOR GYPSUM 30X30

- metal
- dimensions L x W x H: 374 x 374 x 15 mm

930230 Traffic white RAL 9016

25,95 €

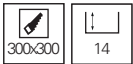

INSERT FRAME FOR GYPSUM 60X60

- metal
- dimensions L x W x H: 674 x 674 x 15 mm

930231 Traffic white RAL 9016

36,95 €

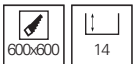

INSERT FRAME FOR GYPSUM 62X62

- metal
- dimensions L x W x H: 699 x 699 x 15 mm

930232 Traffic white RAL 9016

36,95 €





INSERT FRAME FOR GYPSUM 120X30

- metal
- dimensions L x W x H: 1270 x 370 x 15 mm

930233 Traffic white RAL 9016 **49,95 €**



INSERT FRAME FOR GYPSUM 124X62

- metal
- dimensions L x W x H: 1315 x 695 x 15 mm

930234 Traffic white RAL 9016 **59,95 €**





ab page 519



page 522



page 523



page 524



page 525



page 526



page 526



page 527



page 528



page 529



page 530



page 530



page 533



page 533



page 534



page 534



page 535



page 537



page 537



ceiling and wall lights





LUNA

The LUNA series is designed especially, but not only, for the professional shop sector with its wide range of reflectors and different powers and colours. With the optimal accessories, they also put difficult scenes in the right light.



LUNA 20

- aluminium diecast
- dimensions H x Ø: 125 x 85 mm
- socket H x Ø: 16 x 80 mm
- dimmable via leading or trailing edge

348040	<input type="checkbox"/>	Pure white RAL 9010	<input type="checkbox"/>	3000 K	1180 lm	139,95 €
348041	<input checked="" type="checkbox"/>	Signal black RAL 9004	<input type="checkbox"/>	3000 K	1180 lm	139,95 €
348057	<input type="checkbox"/>	Pure white RAL 9010	<input checked="" type="checkbox"/>	4000 K	1440 lm	139,95 €
348058	<input checked="" type="checkbox"/>	Signal black RAL 9004	<input type="checkbox"/>	4000 K	1440 lm	139,95 €



suitable
power rail
spotlights
page 658
707022
707023
707024
707025



accessories

930196	reflector 20°	12,95 €
930239	reflector 30°	12,95 €
930210	barn door white	25,95 €
930211	barn door black	25,95 €



suitable
power rail
spotlights
page 661
707061
707062



suitable
power rail
spotlights
page 659
707018
707019
707026
707027

LUNA 30

- aluminium diecast
- dimensions H x Ø: 153 x 120 mm
- socket H x Ø: 20 x 115 mm
- dimmable via leading or trailing edge

348059	<input type="checkbox"/>	Pure white RAL 9010	<input type="checkbox"/>	3000 K	1970 lm	165,95 €
348060	<input checked="" type="checkbox"/>	Signal black RAL 9004	<input type="checkbox"/>	3000 K	1970 lm	165,95 €
348062	<input checked="" type="checkbox"/>	Signal black RAL 9004	<input checked="" type="checkbox"/>	4000 K	2180 lm	165,95 €

220-240 Volt	30 W	1 LED		Ra>90	40°	
-----------------	------	----------	--	-------	-----	--



accessories

930206	reflector 20°	15,95 €
930207	reflector 30°	15,95 €



LUNA 40

- aluminium diecast
- dimensions H x Ø: 210 x 120 mm
- socket H x Ø: 20 x 115 mm
- dimmable via leading or trailing edge

348063	<input type="checkbox"/>	Pure white RAL 9010	<input type="checkbox"/>	3000 K	2520 lm	199,95 €
348065	<input type="checkbox"/>	Pure white RAL 9010	<input type="checkbox"/>	4000 K	2820 lm	199,95 €
348066	<input checked="" type="checkbox"/>	Signal black RAL 9004	<input type="checkbox"/>	4000 K	2820 lm	199,95 €



suitable
power rail
spotlights
page 660
707020
707021
707028
707029



accessories

930206	reflector 20°	15,95 €
930207	reflector 30°	15,95 €



UNI II

- aluminium diecast
- dimensions H x Ø: 103 x 100 mm
- socket H x Ø: 14,5 x 96 mm
- dimmable via leading or trailing edge

348124 Signal white RAL 9003  3000 K 670 lm **142,95 €**

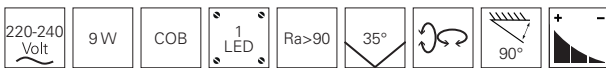

suitable
power rail
spotlight
page 668
707044



With the kind support of Lettisches Haus in Freiburg info@lettischeshaus.de



UNI II

- aluminium diecast
- dimensions L x W x H x Ø: 120 x 95 x 205 x 100 mm
- socket L x W x H: 120 x 43 x 205 mm
- dimmable via leading or trailing edge

341215 white ww 3000 K 670 lm **149,95 €**

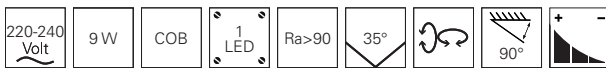

accessories

930339	reflector ring black	9,95 €
930340	reflector ring gold	9,95 €
930341	reflector ring chrom	9,95 €
930371	reflector ring II black glossy	9,95 €
930335	cover backside black	2,95 €
930337	cover heatsink black	2,95 €
930306	reflector 50°	9,95 €
930307	honeycomb filter	9,95 €
930308	spread lens 40° clear/satined	9,95 €
930309	softening lens 47° satined	9,95 €
930310	linear spread lens 40°/80° asymmetric clear/satined	9,95 €



UNI II DOUBLE

- aluminium diecast
- dimensions L x W x H: 212 x 100 x 103 mm
- socket L x W x H: 212 x 20 x 14 mm
- dimmable via leading or trailing edge

348125 Signal white RAL 9003  3000 K 1350 lm **253,95 €**

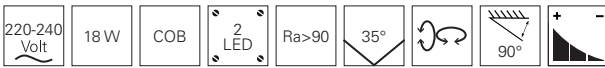

With the kind support of Lettisches Haus in Freiburg info@lettischeshaus.de



UNI II TRIPLE

- aluminium diecast
- dimensions L x W x H: 324 x 100 x 103 mm
- socket L x W x H: 315 x 25 x 14,5 mm
- dimmable via leading or trailing edge

348107 Signal white RAL 9003 ww 3000 K 2150 lm **359,95 €**

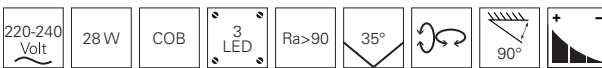

accessories for UNI II series

930339	reflector ring black	9,95 €
930340	reflector ring gold optics	9,95 €
930341	reflector ring chrom	9,95 €
930371	reflector ring II black glossy	9,95 €
930335	cover backside black	2,95 €
930337	cover heatsink black	2,95 €
930306	reflector 50°	9,95 €
930307	honeycomb filter	9,95 €
930308	spread lens 40° clear/satined	9,95 €
930309	softening lens 47° satined	9,95 €
930310	linear spread lens 40°/80° asymmetric clear/satined	9,95 €



UNI II MINI

- aluminium diecast
- dimensions L x H: 91 x 75 mm
- socket H x Ø: 44 x 75 mm
- dimmable via leading or trailing edge

348122 Signal white RAL 9003  3000 K 600 lm **123,95 €**

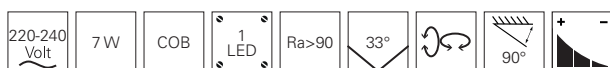

UNI II MINI DOUBLE

- aluminium diecast
- dimensions L x W x H: 160 x 75 x 91 mm
- socket L x W x H: 160 x 75 x 44 mm
- dimmable via leading or trailing edge

348123 Signal white RAL 9003  3000 K 980 lm **199,95 €**

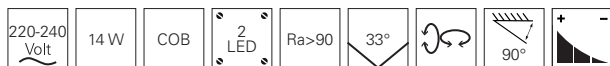

accessories for UNI II MINI series

930331	reflector ring black	9,95 €
930332	reflector ring gold	9,95 €
930333	reflector ring chrom	9,95 €
930381	reflector ring II black	9,95 €
930327	cover backside black	2,95 €
930329	cover heatsink black	2,95 €



UNI II MAX

- aluminium diecast
- dimensions H x Ø: 128 x 125 mm
- socket H x Ø: 62 x 125 mm
- dimmable via leading or trailing edge

348127 Signal white RAL 9003  3000 K 2410 lm **249,95 €**

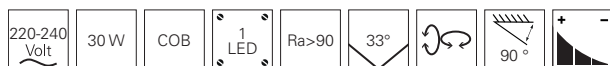

accessories for UNI II MAX

930398	reflector ring black	9,95 €
930399	reflector ring gold	9,95 €
930382	reflector ring II black glossy	9,95 €
930394	cover backside black	2,95 €
930396	cover heatsink black	3,95 €
930390	reflector 24°	9,95 €
930392	reflector 50°	9,95 €



suitable
built in ceiling
lights
page 470
565250
565251
565252



suitable
built in ceiling
lights
page 474
565256
565257
565258

CETI 5

- aluminium diecast
- dimensions L x W x H: 129 x 73 x 211 mm
- socket L x W x H: 76 x 32 x 211 mm
- dimmable via leading or trailing edge

341214 white mat, anthracite  3000 K 780 lm **159,95 €**

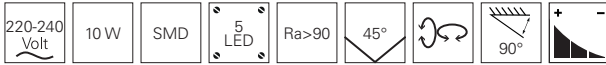

accessories

- 930218** reflector silver coloured **14,95 €**
930215 reflector gold optics **15,95 €**





suitable
power rail
spotlights
page 648
620119
620120

DRACONIS

- light colour and output adjustable via CCT dip switch
- high luminous intensity [bis 8200 lm]
- aluminium diecast
- dimensions L x W x H: 578 x 189 x 71 mm
- socket L x W x H: 102 x 88 x 25 mm

348128	<input type="checkbox"/>	Traffic white RAL 9016		2700 / 3500 / 4000 K	8215 lm	249,95 €
348099	<input type="checkbox"/>	White aluminium RAL 9006		2700 / 3500 / 4000 K	8215 lm	249,95 €



suitable
pendant lights
page 547
620121
620122

220-240 50Hz Volt	45W/ 55W/ 72W	SMD	198 LED	Ra>80	60°
-------------------------	---------------------	-----	------------	-------	-----



accessories

930577	15° Linse asymmetric	7,95 €
930544	20° Linse symmetric	7,95 €
930545	30° Linse symmetric	7,95 €
930546	90° Linse symmetric	7,95 €



HELEN I 3 COLOUR

- plastic
- dimensions H x Ø: 83 x 276 mm
- socket H x Ø: 20 x 251 mm
- light color adjustable via dip switch [CCT DIP]

348051 silver coloured brushed ww nw cw 3000/4100/5500 K 1400 lm **75,95 €**

220-240 Volt	15 W	SMD	84 LED	Ra>80	115°	IP54
-----------------	------	-----	-----------	-------	------	------



HELEN II 3 COLOUR

- plastic
- dimensions H x Ø: 89 x 351 mm
- socket H x Ø: 22 x 326 mm
- light color adjustable via dip switch [CCT DIP]

348052 silver coloured brushed ww nw cw 3000/4100/5500 K 1800 lm **95,95 €**

220-240 Volt	19 W	SMD	120 LED	Ra>80	115°	IP54
-----------------	------	-----	------------	-------	------	------





ALTAIS

It takes a lot to bring the Altai series into embarrassment. Thanks to IP54 and impact resistance class IK10, the outdoor luminaires are convincing as slim all-rounders in both public and private areas. The Altai luminaires offer additional flexibility thanks to their integrated motion sensor [programmable via the remote control supplied] and the adjustable light colour for different lighting scenarios.



product video





ALTAIS

- light color adjustable via dip switch [CCT DIP]
- 75.000 switching cycles
- plastic

348141	<input type="checkbox"/>	white	WW	NW	CW	3000/4000/6000 K	1260 lm	H x Ø: 48 x 220 mm	12W	55,95 €
348143	<input type="checkbox"/>	white	WW	NW	CW	3000/4000/6000 K	1870 lm	H x Ø: 48 x 280 mm	18W	67,95 €
348145	<input type="checkbox"/>	white	WW	NW	CW	3000/4000/6000 K	2715 lm	H x Ø: 48 x 330 mm	25W	85,95 €

220-240 Volt	SMD	LED	Ra>85	120°	IP54	IK10
--------------	-----	-----	-------	------	------	------



ALTAIS MOTION

- light color adjustable via dip switch [CCT DIP]
- detection area, daylight sensor and light duration can be individualised via remote control
- 75.000 switching cycles
- plastic
- incl. remote control
- incl. motion sensor

348142	<input type="checkbox"/>	white	WW	NW	CW	3000/4000/6000 K	1260 lm	H x Ø: 48 x 220 mm	12W	85,95 €
348144	<input type="checkbox"/>	white	WW	NW	CW	3000/4000/6000 K	1870 lm	H x Ø: 48 x 280 mm	18W	99,95 €
348146	<input type="checkbox"/>	white	WW	NW	CW	3000/4000/6000 K	2715 lm	H x Ø: 48 x 330 mm	25W	115,95 €

220-240 Volt	SMD	LED	Ra>85	120°		IP54	IK10
--------------	-----	-----	-------	------	--	------	------



SUBRA TRIAC

- classic design with illuminated strip as highlight
- easy mounting by means of clip connection
- dimmable via TRIAC
- high light output
- IP54 ceiling mounting / IP20 wall mounting
- aluminium
- dimensions H x Ø: 70 x 350 mm
- socket H x Ø: 22 x 290 mm
- dimmable via leading or trailing edge

401007	<input type="checkbox"/> white	<input checked="" type="checkbox"/> ww	3000 K	2600 lm	235,95 €
401008	<input type="checkbox"/> white	<input checked="" type="checkbox"/> nw	4000 K	2840 lm	235,95 €

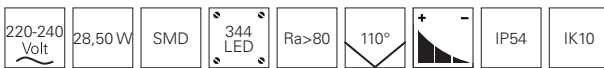

SUBRA MOTION

- classic design with illuminated strip as highlight
- easy mounting by means of clip connection
- einstellbarer motion sensor
- high light output
- IP54 ceiling mounting / IP20 wall mounting
- aluminium
- dimensions H x Ø: 70 x 350 mm
- socket H x Ø: 22 x 290 mm

401005	<input type="checkbox"/> white	<input checked="" type="checkbox"/> ww	3000 K	2603 lm	295,95 €
401006	<input type="checkbox"/> white	<input checked="" type="checkbox"/> nw	4000 K	2651 lm	295,95 €

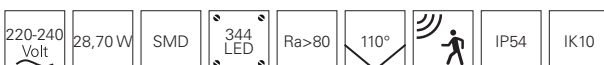



SUBRA DALI

- classic design with illuminated strip as highlight
- easy mounting by means of clip connection
- dimmable via DALI
- high light output
- IP54 ceiling mounting / IP20 wall mounting
- aluminium
- dimensions H x Ø: 70 x 350 mm
- socket H x Ø: 22 x 290 mm

401003	<input type="checkbox"/> white	<input checked="" type="checkbox"/> ww 3000 K	2636 lm	309,95 €
401004	<input type="checkbox"/> white	<input checked="" type="checkbox"/> nw 4000 K	2671 lm	309,95 €

220-240 Volt	28,90 W	SMD	344 LED	Ra>80	110°		IP54	IK10
--------------	---------	-----	---------	-------	------	--	------	------





With the kind support of Regionaldirektion für Deutsche Vermögensberatung Pierre Werner / Direktion für Deutsche Vermögensberatung Uwe Liebholz

SCULPTORIS

Thanks to its different versions, the SCULPTORIS series can be optimally integrated both in the bedroom as a surface-mounted ceiling luminaire and in the living or dining area as a pendant luminaire.





product video



SCULPTORIS 45

- aluminium
- dimensions H x Ø: 130 x 450 mm
- socket H x Ø: 22 x 395 mm
- dimmable via leading or trailing edge

348103	<input type="checkbox"/>	Signal white RAL 9003	 3000 K	1700 lm	199,95 €
348104	<input type="checkbox"/>	Signal white RAL 9003	 4000 K	1700 lm	199,95 €

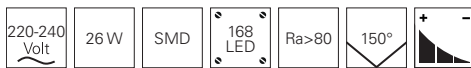



suitable
pendant
lights
page 548
342122
342123



SCULPTORIS 60

- aluminium
- dimensions H x Ø: 130 x 600 mm
- socket H x Ø: 25 x 525 mm
- dimmable via leading or trailing edge

348105	<input type="checkbox"/>	Signal white RAL 9003	 3000 K	2600 lm	259,95 €
348106	<input type="checkbox"/>	Signal white RAL 9003	 4000 K	2800 lm	259,95 €

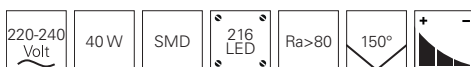

suitable
pendant
lights
page 548
342124
342125



□ □ ■
page 541



□ □ ■
page 541



□ □ ■
page 541



□ □ ■
page 543



□ □ ■
page 543



□ □ ■
page 543



□ □
page 545



□ □
page 547



□ □
page 548



□ □ ■
page 551



□ □ ■
page 553



pendant lamps





D PROFESSION DOWN

Thanks to their flexible control options, you can use the D PROFESSION pendant luminaires in both private and commercial applications. In the private sector, the dimmable down version creates a great lighting mood that harmonises perfectly with its modern design.



D PROFESSION DOWN

- powerful light output
- UGR <19
- ideal for home office or dining / living area
- aluminium
- dimensions L x W x H: 1177 x 53 x 53 mm
- socket L x W x H: 560 x 65 x 38 mm
- max. suspension: 3000 mm

+ POWER SUPPLY TRIAC

- dimmable via leading or trailing edge
- if required, by purchasing a corresponding base can be converted to DALI or 1-10V dimmable at any time

620107	<input type="checkbox"/> white	<input type="checkbox"/> NW	4000 K	3165 lm	329,90 €
620110	<input type="checkbox"/> silver coloured	<input type="checkbox"/> NW	4000 K	3165 lm	329,90 €
620103	<input type="checkbox"/> black	<input type="checkbox"/> NW	4000 K	3165 lm	329,90 €



+ POWER SUPPLY 1-10V

- dimmable via 1-10V
- if required, by purchasing a corresponding base can be converted to DALI oder Triac dimmable at any time

620106	<input type="checkbox"/> white	<input type="checkbox"/> NW	4000 K	3165 lm	339,90 €
620109	<input type="checkbox"/> silver coloured	<input type="checkbox"/> NW	4000 K	3165 lm	339,90 €
620102	<input type="checkbox"/> black	<input type="checkbox"/> NW	4000 K	3165 lm	339,90 €

+ POWER SUPPLY DALI

- dimmable via DALI-Bus according to IEC 62386 DALI 1.0
- if required, by purchasing a corresponding base can be converted to TRIAC oder 1-10V dimmable at any time

620105	<input type="checkbox"/> white	<input type="checkbox"/> NW	4000 K	3165 lm	359,90 €
620108	<input type="checkbox"/> silver coloured	<input type="checkbox"/> NW	4000 K	3165 lm	359,90 €
620057	<input type="checkbox"/> black	<input type="checkbox"/> NW	4000 K	3165 lm	359,90 €

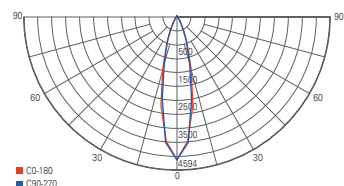
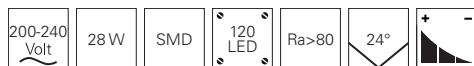

light distribution curve 620107

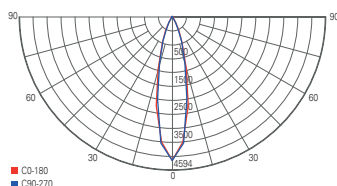

light distribution curve 620106

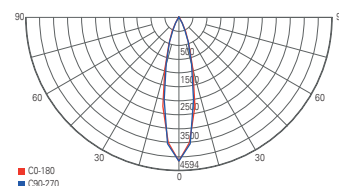

light distribution curve 620105



D PROFESSION UP AND DOWN

Thanks to their flexible control options, you can use the D PROFESSION pendant luminaires in both private and commercial applications. The UP and Down version emits its light in two directions. While the upward LEDs create a pleasant, indirect room light, the downward LEDs provide a defined, powerful and UGR-compliant office and task light for desks and more.



D PROFESSION UP AND DOWN

- powerful light output
- UGR <19
- ideal for home office or dining / living area
- aluminium
- dimensions L x W x H: 1177 x 53 x 53 mm
- socket L x W x H: 560 x 65 x 38 mm
- max. suspension: 3000 mm

+ POWER SUPPLY TRIAC

- dimmable via leading or trailing edge
- if required, by purchasing a corresponding base can be converted to DALI or 1-10V dimmable at any time

620111	<input type="checkbox"/> white	<input type="checkbox"/> NW	4000 K	7180 lm	389,90 €
620104	<input type="checkbox"/> silver coloured	<input type="checkbox"/> NW	4000 K	7180 lm	389,90 €
620112	<input type="checkbox"/> black	<input type="checkbox"/> NW	4000 K	7180 lm	389,90 €

+ POWER SUPPLY 1-10V

- dimmable via 1-10V
- if required, by purchasing a corresponding base can be converted to DALI oder Triac dimmable at any time

620114	<input type="checkbox"/> white	<input type="checkbox"/> NW	4000 K	7180 lm	389,90 €
620113	<input type="checkbox"/> silver coloured	<input type="checkbox"/> NW	4000 K	7180 lm	389,90 €
620115	<input type="checkbox"/> black	<input type="checkbox"/> NW	4000 K	7180 lm	389,90 €

+ POWER SUPPLY DALI

- dimmable via Dali Bus according to IEC62386 DALI 1.0
- if required, by purchasing a corresponding base can be converted to TRIAC oder 1-10V dimmable at any time

620117	<input type="checkbox"/> white	<input type="checkbox"/> NW	4000 K	7180 lm	419,90 €
620116	<input type="checkbox"/> silver coloured	<input type="checkbox"/> NW	4000 K	7180 lm	419,90 €
620118	<input type="checkbox"/> black	<input type="checkbox"/> NW	4000 K	7180 lm	419,90 €

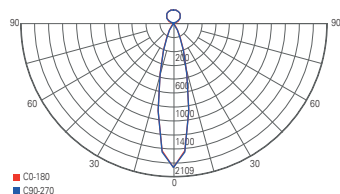
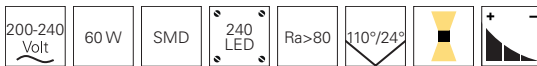

light distribution curve 620111

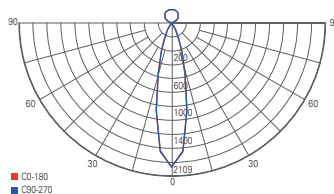

light distribution curve 620114

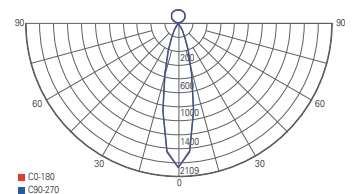

light distribution curve 620117



OFFICE THREE DALI 2.0

The pendant luminaire is a matching addition to the OFFICE THREE MOTION floor lamp. As the glare value is less than 10, this technically sophisticated luminaire can almost be described as completely glare-free. The upward-facing LEDs create ambient light, while the downward-facing LEDs shine clearly defined and powerful light onto the work area.



OFFICE THREE DALI 2.0

- aluminium
- dimensions L x W x H: 1179 x 64 x 35 mm
- socket L x W x H: 600 x 57 x 35 mm
- max. suspension: 2500 mm
- UGR<10
- dimmable via Dali Bus according to IEC62386 DALI 2.0

342147 Signal white RAL 9003 NW 4000 K
342146 White aluminium RAL 9006 NW 4000 K

7000 lm **499,95 €**
 7000 lm **499,95 €**

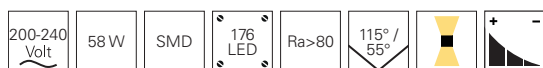

suitable
 floor light
 page 563
343024
343023

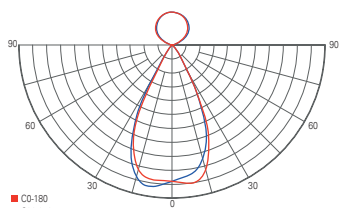

■ CO-180
 ■ CO-270

light distribution curve



DRACONIS

The modular DRACONIS series enables flexible ceiling lighting for a wide range of applications. Combine the luminaire head with our mounting adapters for optional use as a fixed surface-mounted ceiling luminaire, in a 3-phase track system or as a suspended luminaire and flexibly adjust the output and light colour. In addition, we offer several lenses for asymmetric and symmetric illumination in multiple beam angles to use the DRACONIS in almost any scenario.

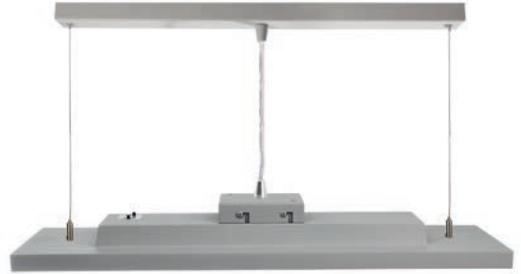

DRACONIS

- light colour and output adjustable via CCT dip switch
- high luminous intensity [bis 8200 lm]
- aluminium diecast
- dimensions L x W x H: 578 x 189 x 71 mm
- socket L x W x H: 500 x 40 x 23 mm
- max. suspension: 1750 mm

620122	<input type="checkbox"/>	Traffic white RAL 9016	<input type="checkbox"/>	WW	<input type="checkbox"/>	NW	2700 / 3500 / 4000 K	8215 lm	369,95 €
620121	<input type="checkbox"/>	White aluminium RAL 9006	<input type="checkbox"/>	WW	<input type="checkbox"/>	NW	2700 / 3500 / 4000 K	8215 lm	369,95 €

220-240 50Hz Volt	45W/ 55W/ 72W	SMD	198 LED	Ra>80	60°
-------------------------	---------------------	-----	------------	-------	-----



suitable
power rail
spotlights
page 648
620119
620120



suitable
ceiling lights
page 529
348128
348099



accessories

930577	15° lens asymmetric	7,95 €
930544	20° lens symmetric	7,95 €
930545	30° lens symmetric	7,95 €
930546	90° lens symmetric	7,95 €

7,95 €

7,95 €

7,95 €

7,95 €

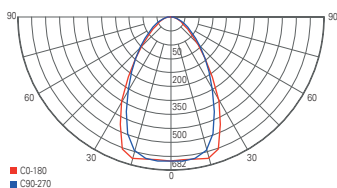

light distribution curve WW | 45W

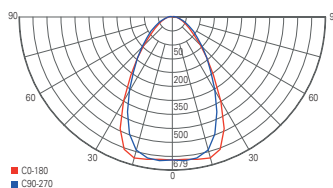

light distribution curve WW | 55W

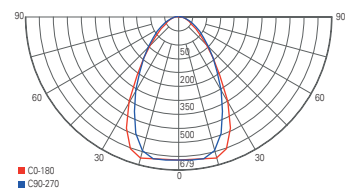

light distribution curve WW | 72W



SCULPTORIS 45

- aluminium
- dimensions H x Ø: 130 x 450 mm
- socket H x Ø: 65 x 230 mm
- max. suspension: 1200 mm
- dimmable via leading or trailing edge

342122	<input type="checkbox"/>	Signal white RAL 9003 mat	<input type="checkbox"/>	3000 K	1700 lm	219,95 €
342123	<input type="checkbox"/>	Signal white RAL 9003 mat	<input type="checkbox"/>	4000 K	1700 lm	219,95 €



suitable
ceiling
lights
page 537
348103
348104



SCULPTORIS 60

- aluminium
- dimensions H x Ø: 130 x 600 mm
- socket H x Ø: 65 x 230 mm
- max. suspension: 1200 mm
- dimmable via leading or trailing edge

342124	<input type="checkbox"/>	Signal white RAL 9003 mat	<input type="checkbox"/>	3000 K	2600 lm	269,95 €
342125	<input type="checkbox"/>	Signal white RAL 9003 mat	<input type="checkbox"/>	4000 K	2800 lm	269,95 €



suitable
ceiling
lights
page 537
348105
348106





LED PANEL TRANSPARENT RUND

The special feature of this pendant luminaire is the transparent light body. When switched off, the surface is almost completely transparent. When the light is switched on, the disc distributes the light almost glare-free. With a glare value [UGR] of less than 19, this pendant luminaire is absolutely suitable for office use. Bright, efficient and with an extraordinary design, this luminaire stands out in any office setting.



LED PANEL TRANSPARENT RUND

- aluminium
- dimensions H x Ø: 12,50 x 580 mm
- socket H x Ø: 45,00 x 250 mm
- max. suspension: 1500 mm
- UGR <19
- dimmable via leading or trailing edge

342091	<input type="checkbox"/>	Traffic white RAL 9016	<input type="checkbox"/>	3000 K	5100 lm	319,95 €
342094	<input type="checkbox"/>	Traffic white RAL 9016	<input type="checkbox"/>	4000 K	5600 lm	319,95 €
342090	<input type="checkbox"/>	White aluminium RAL 9006	<input type="checkbox"/>	3000 K	5100 lm	319,95 €
342093	<input type="checkbox"/>	White aluminium RAL 9006	<input type="checkbox"/>	4000 K	5600 lm	319,95 €
342089	<input type="checkbox"/>	Jet black RAL 9005	<input type="checkbox"/>	3000 K	5100 lm	319,95 €
342092	<input type="checkbox"/>	Jet black RAL 9005	<input type="checkbox"/>	4000 K	5600 lm	319,95 €

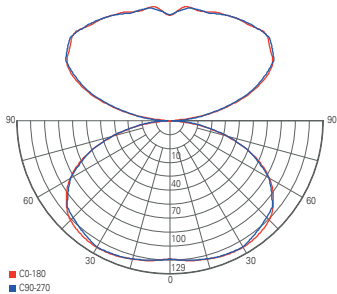

light distribution curve



LED PANEL TRANSPARENT

The LED pendant luminaire has a transparent glass for direct and indirect light distribution, which is almost transparent when switched off. When the light is switched on, the glass distributes the light almost glare-free. With a glare value [UGR] of less than 19, this pendant luminaire is absolutely suitable for office use. Bright, efficient and with an extraordinary design, this luminaire not only stands out in any office setting.



LED PANEL TRANSPARENT

- aluminium
- dimensions L x W x H: 1195 x 295 x 11 mm
- socket L x W x H: 580 x 80 x 40 mm
- max. suspension: 1500 mm
- UGR < 19
- dimmable via leading or trailing edge

342079	<input type="checkbox"/>	Traffic white RAL 9016	<input type="checkbox"/>	3000 K	6000 lm	319,95 €
342082	<input type="checkbox"/>	Traffic white RAL 9016	<input type="checkbox"/>	4000 K	6000 lm	319,95 €
342078	<input type="checkbox"/>	White aluminium RAL 9006	<input type="checkbox"/>	3000 K	6000 lm	319,95 €
342081	<input type="checkbox"/>	White aluminium RAL 9006	<input type="checkbox"/>	4000 K	6000 lm	319,95 €
342077	<input type="checkbox"/>	Jet black RAL 9005	<input type="checkbox"/>	3000 K	6000 lm	319,95 €
342080	<input type="checkbox"/>	Jet black RAL 9005	<input type="checkbox"/>	4000 K	6000 lm	319,95 €

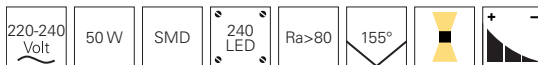

suitable
floor light
page 561
343022

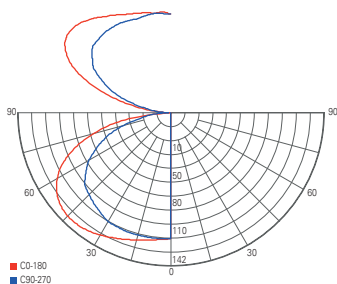

light distribution curve



□
page 556



□
page 557



□
page 559



□
page 561



□ □
page 563



floor lights





rotary switch

OFFICE TWO

- SDCM <3
- L80
- B10
- aluminium
- dimensions L x W x H: 1950 x 310 x 42 mm
- socket L x W: 450 x 270 mm
- UGR<19
- dimmable via rotary switch
- incl. 2,5 m connection cable with mains plug

343016 White aluminium RAL 9006 NW 4000 K 8300 lm **649,95 €**

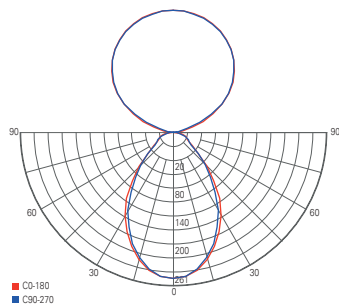

light distribution curve

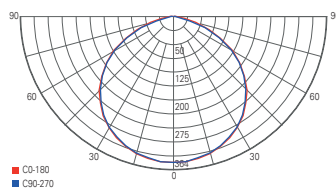

light distribution curve nach oben

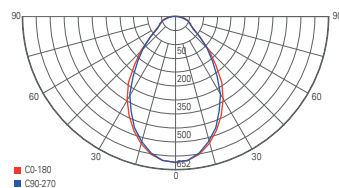

light distribution curve nach unten



touch sensor

OFFICE ONE

- SDCM ≤ 3
- L80
- B10
- aluminium
- dimensions L x W x H: 1950 x 310 x 30 mm
- socket L x W: 460 x 300 mm
- UGR<math>< 19</math>
- dimmable via touch sensor
- incl. 1,5 m connection cable with connector and device connector C21

343018 White aluminium RAL 9006 NW 4000 K 6500 lm **749,95 €**

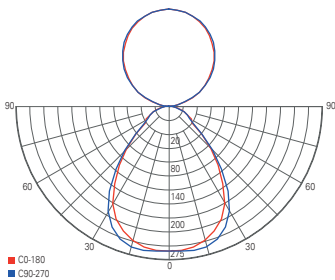
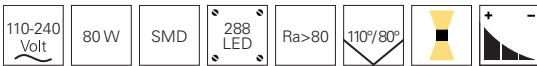

light distribution curve

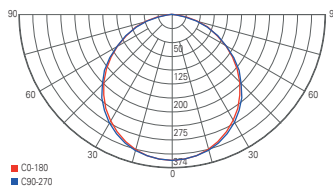

light distribution curve nach oben

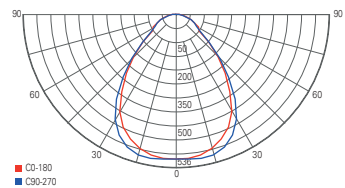

light distribution curve nach unten



motion sensor
and daylight sensor

MOTION SENSOR

- the luminaire switches on automatically when there is movement
- without movement, the brightness is reduced to 30% after 30 min
- without movement, the luminaire switches off after 30 min.

DAYLIGHT SENSOR

- Switch on the luminaire and dim it to the desired brightness dim [this setting is saved by the daylight sensor as the saves this setting as default]
- if the ambient light changes, the sensor adjusts the brightness to the stored standard [10% tolerance]





touch sensor

OFFICE ONE MOTION

- SDCM <3
- L80
- B10
- aluminium
- dimensions L x W x H: 1950 x 310 x 30 mm
- socket L x W: 460 x 300 mm
- UGR<19
- dimmable via touch sensor
- motion sensor
- daylight sensor
- incl. 1,5 m connection cable with connector and device connector C21

343019 White aluminium RAL 9006 NW 4000 K 6500 lm **849,95 €**

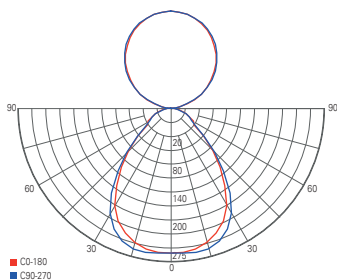

light distribution curve

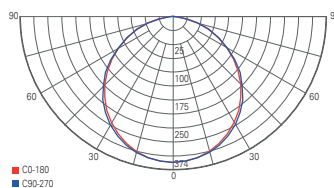

light distribution curve nach oben

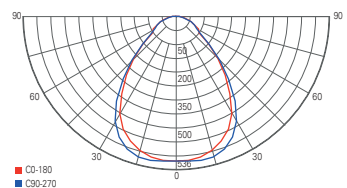

light distribution curve nach unten





touch sensor

OFFICE ONE TRANSPARENT

- aluminium
- dimensions L x W x H: 1950 x 310 x 20 mm
- socket L x W: 460 x 30 mm
- UGR < 19
- dimmable via touch sensor
- incl. 2,5 m connection cable with connector IP44

343022 White aluminium RAL 9006 NW 4000 K 6200 lm **749,95 €**



suitable
pendant lights
page 553
342078
342081

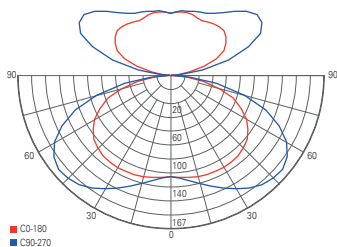

light distribution curve

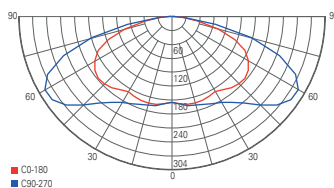

light distribution curve nach oben

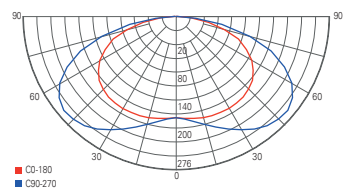

light distribution curve nach unten

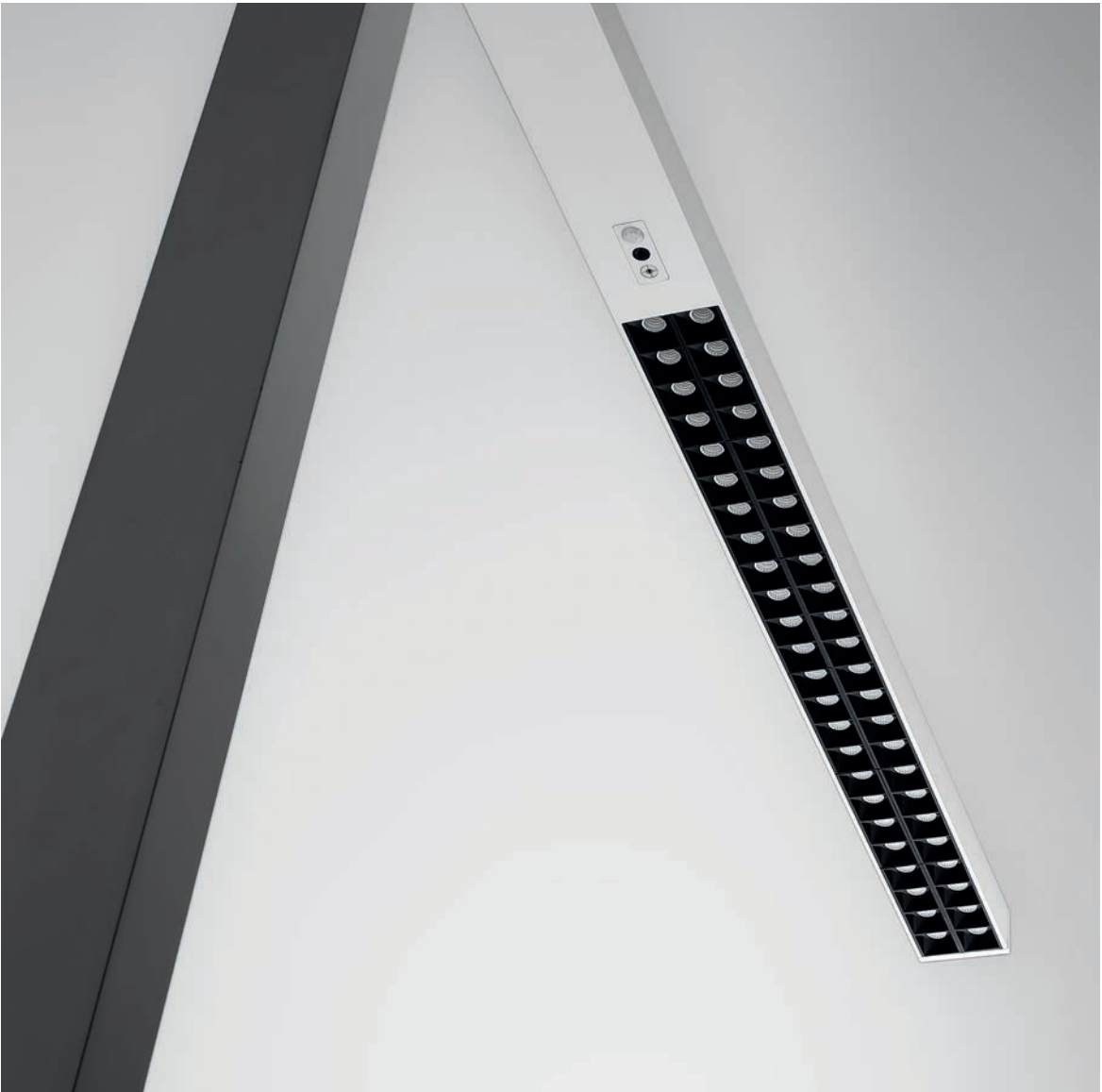

OFFICE THREE MOTION

A modern floor lamp for offices with modern control technology. The minimalist luminaire switches on automatically when movement is detected. In addition, the OFFICE THREE MOTION adapts to the existing daylight conditions and regulates the brightness for relaxed working even over longer periods of time.



motion sensor
and daylight sensor



touch dimmer

OFFICE THREE MOTION

- SDCM <3
- L80
- B10
- aluminium
- dimensions L x W x H: 1950 x 64 x 1056 mm
- socket L x W: 500 x 225 mm
- UGR<6
- dimmable via touch sensor
- motion sensor
- daylight sensor
- incl. 2,5 m connection cable with connector IP20

343024	<input type="checkbox"/>	Signal white RAL 9003 matt	NW	4000 K	9600 lm	999,95 €
343023	<input type="checkbox"/>	White aluminium RAL 9006	NW	4000 K	9600 lm	999,95 €

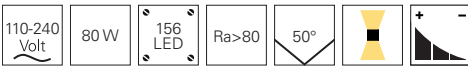

suitable
pendant lights
page 545
342147
342146

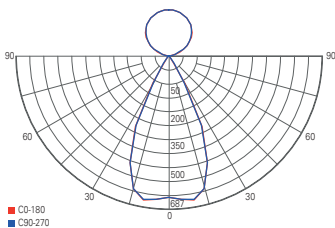

light distribution curve

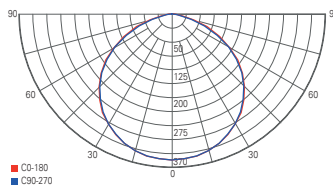

light distribution curve nach oben

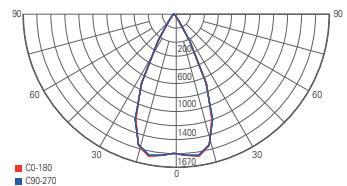

light distribution curve nach unten

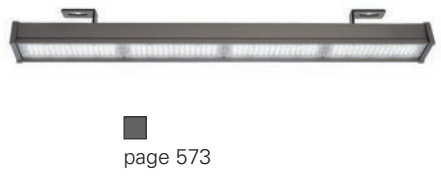
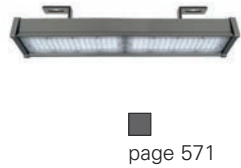
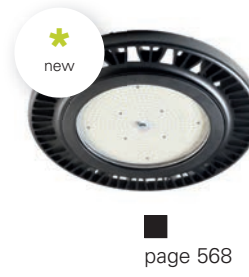
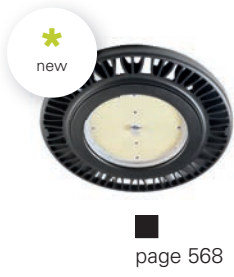
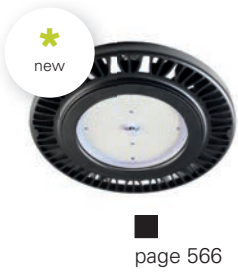



hall floodlight



ALUDRA

Whether in high-bay warehouses, large sales areas or spacious presentation areas – the pendant luminaires of the ALUDRA series present themselves as universal high-bay luminaires for use at great heights. Thanks to their high luminous intensity, wide beam angle and IK10 impact resistance class, the ALUDRA luminaires provide functional lighting for large areas safely and reliably.

ALUDRA 100W

- high luminous intensity
- optimum illumination for e.g. warehouses or sales areas
- aluminium
- dimensions H x Ø: 153 x 360 mm
- incl. 3 m connection cable

732138 ■ black CW 5000 K 15030 lm **269,95 €**

200-240 Volt	100 W	SMD	LED	Ra>80	120°	IP65	IK10
--------------	-------	-----	-----	-------	------	------	------

accessories

930590 reflector **49,95 €**

930641 suspension set **13,95 €**

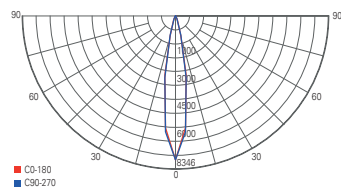

light distribution curve



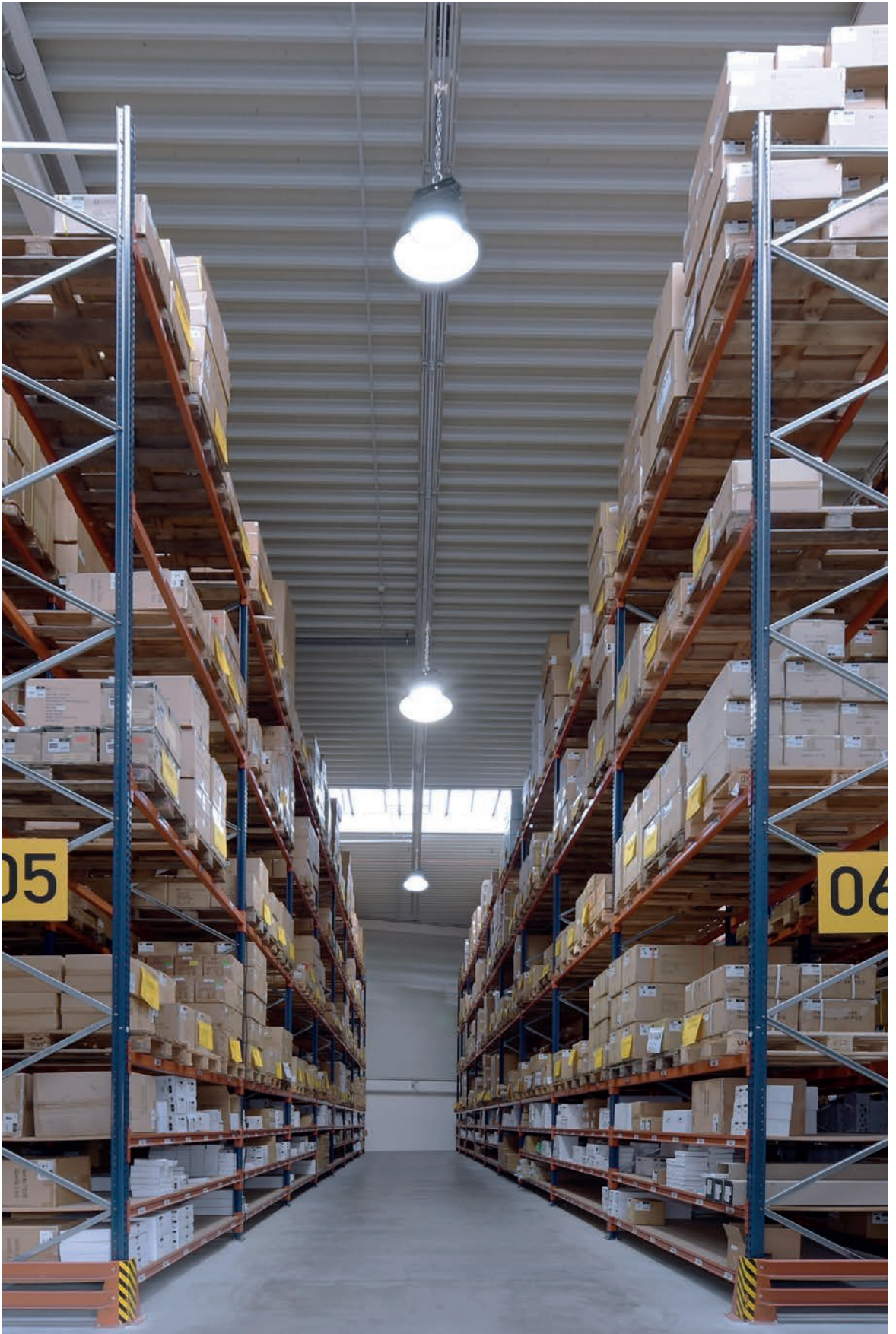

ALUDRA 160W

- high luminous intensity
- optimum illumination for e.g. warehouses or sales areas
- aluminium
- dimensions H x Ø: 165 x 360 mm
- incl. 3 m connection cable

732139 ■ black CW 5000 K 24450 lm **319,95 €**

200-240 Volt	160 W	SMD	LED	Ra>80	120°	IP65	IK10
--------------	-------	-----	-----	-------	------	------	------

accessories

- 930590** reflector **45,95 €**
930641 suspension set **13,95 €**

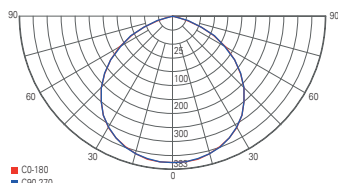
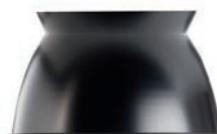

light distribution curve

ALUDRA 200W

- high luminous intensity
- optimum illumination for e.g. warehouses or sales areas
- aluminium
- dimensions H x Ø: 178 x 405 mm
- incl. 3 m connection cable

732140 ■ black CW 5000 K 30300 lm **395,95 €**

200-240 Volt	200 W	SMD	LED	Ra>80	120°	IP65	IK10
--------------	-------	-----	-----	-------	------	------	------

accessories

- 930590** reflector **45,95 €**
930642 suspension set **49,95 €**

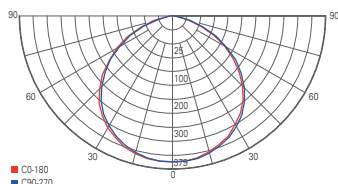
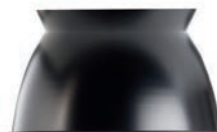

light distribution curve

ALUDRA 100W DALI

- high luminous intensity
- optimum illumination for e.g. warehouses or sales areas
- aluminium
- dimensions H x Ø: 153 x 360 mm
- incl. 3 m connection cable
- DALI Bus according to IEC62386 DALI 1.0

732141 ■ black cw 5000 K 15415 lm **319,95 €**

200-240 Volt	100 W	SMD	LED	Ra>80	120°	IP65	IK10
--------------	-------	-----	-----	-------	------	------	------

accessories

930590 reflector **45,95 €**

930641 suspension set **13,95 €**

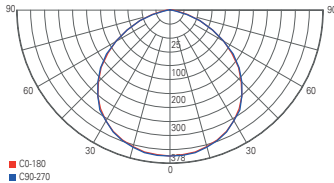

light distribution curve



ALUDRA 200W DALI

- high luminous intensity
- optimum illumination for e.g. warehouses or sales areas
- aluminium
- dimensions H x Ø: 178 x 405 mm
- incl. 3 m connection cable
- DALI Bus according to IEC62386 DALI 1.0

732142 ■ black cw 5000 K 29315 lm **475,95 €**

200-240 Volt	200 W	SMD	LED	Ra>80	120°	IP65	IK10
--------------	-------	-----	-----	-------	------	------	------

accessories

930590 reflector **45,95 €**

930642 suspension set **49,95 €**

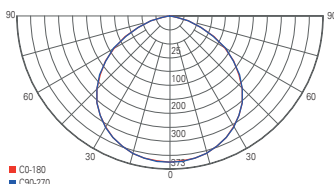

light distribution curve

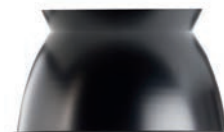



HIGHBAY NORMAE

The energy-efficient Highbay spotlights are ideal for hall lighting. Thanks to the adjustable mounting set, the spotlights can be mounted at the desired angle of inclination. With the corresponding set, there is also the option of suspending them and, if required, equipping them with asymmetrical lenses.



HIGHBAY NORMAE

- aluminium diecast
- dimensions L x W x H: 627 x 126 x 99 mm
- socket L x W x H: 110 x 70 x 95 mm
- DALI Bus according to IEC62386

732083 ■ dark grey ■ cw 5000 K 10790 lm **249,95 €**

200-240 Volt	90 W	SMD	128 LED	Ra>80	90°	↻	180°	+	IP65	IK08
--------------	------	-----	---------	-------	-----	---	------	---	------	------



accessories

930295 linear Highbase Lens 30°/70° 290 x 86 x 8 mm **25,95 €**
930293 suspension set L: 1000 mm **34,95 €**

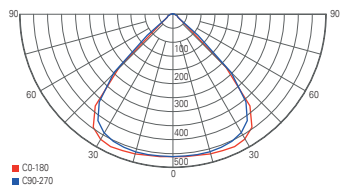

light distribution curve HIGHBAY NORMAE with lens 90°

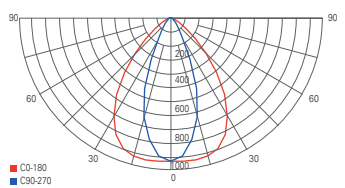
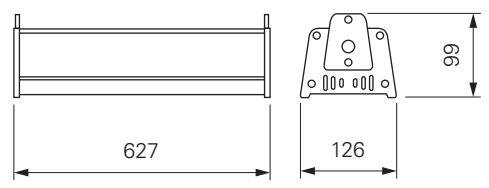

light distribution curve HIGHBAY NORMAE with lens 30°/70°



HIGHBAY NORMAE

- aluminium diecast
- dimensions L x W x H: 923 x 126 x 99 mm
- socket L x W x H: 110 x 70 x 95 mm
- DALI Bus according to IEC62386

732084 ■ dark grey cw 5000 K 16700 lm **349,95 €**



accessories

930295 linear Highbase Lense 30°/70° 290 x 86 x 8 mm **25,95 €**
930293 suspension set L: 1000 mm **34,95 €**

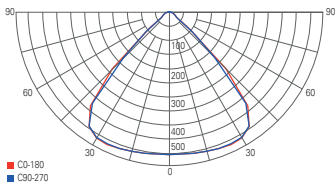

light distribution curve HIGHBAY NORMAE with lens 90°

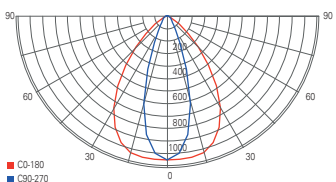

light distribution curve HIGHBAY NORMAE with lens 30°/70°

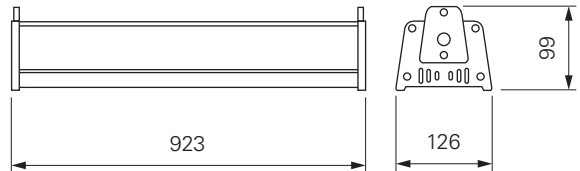



HIGHBAY NORMAE

- aluminium diecast
- dimensions L x W x H: 1219 x 126 x 99 mm
- socket L x W x H: 110 x 70 x 95 mm
- DALI Bus according to IEC62386

732085 ■ dark grey cw 5000 K 23800 lm **449,95 €**

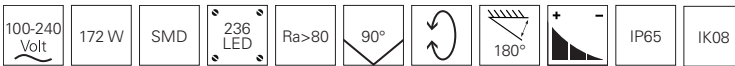

accessories

930295 linear Highbase Lense 30°/70° 290 x 86 x 8 mm **25,95 €**

930293 suspension set L: 1000 mm **34,95 €**

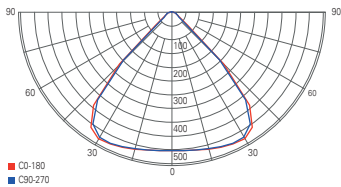

light distribution curve HIGHBAY NORMAE with lens 90°

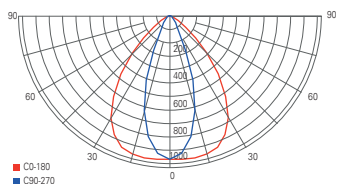
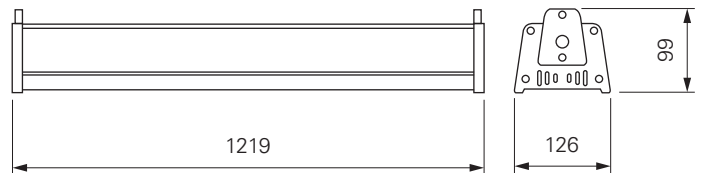

light distribution curve HIGHBAY NORMAE with lens 30°/70°



page 577



page 577



page 579



page 580



page 581



page 582



page 582



damp-proof luminaires





With the kind support of WIBU-SYSTEMS AG Karlsruhe

TRI PROOF SLIM

Waterproof, impact-resistant and versatile – the surface-mounted ceiling luminaires of the TRI PROOF SLIM series are flexible workhorses with an innovative design. Whether in wet areas, cellars, workshops, garages or warehouses – the IP68-certified SLIMS are impact-resistant up to IK10 and their beam angle can be continuously adjusted.



TRI PROOF SLIM

- plastic
- dimension Ø: 39 mm
- infinitely adjustable beam angle
- easy installation in existing mountings [e.g. pipe clamps]
- easy connection due to quick connection terminals
- simple through-wiring
- incl. 4x screws, 4x dowels, 2x bracket clip, 2x quick connection clip, 1x cable connection cap

348138	<input type="checkbox"/>	white mat	L: 700 mm	<input checked="" type="checkbox"/> cw	5000 K	108 LEDs	2265 lm	21 W	79,95 €
348139	<input type="checkbox"/>	white mat	L: 1300 mm	<input checked="" type="checkbox"/> cw	5000 K	220 LEDs	4575 lm	40 W	125,95 €



through-wiring

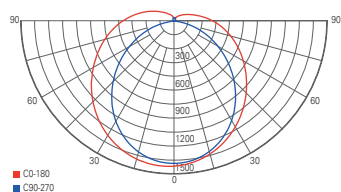

light distribution curve 348138

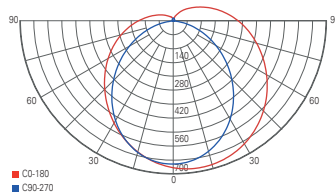

light distribution curve 348139



TRI PROOF

Equipped with LEDs in neutral white light colour [4000 K], the TRIPROOF LED IP65 moisture-proof luminaire consists of a light grey polycarbonate housing and a satinised polycarbonate cover in one piece. It is suitable for simple ceiling, wall or pendant mounting and is available in three different lengths.

Several can be strung together; ideal for industrial and private use, e.g. for lighting under canopies, in basements, workshops, garages, industrial halls, etc. The luminaire is provided with a simple electrical connection with plug-in terminal.





TRI PROOF

- plastic
- dimensions W x H: 61 x 56 mm
- stackable up to 25 / 15 / 10 pieces
- incl. 3 mountings clips

730419	<input type="checkbox"/>	white mat	L: 696 mm	<input type="checkbox"/>	NW	4000 K	44 LEDs	1430 lm	16,80 W	39,95 €
730424	<input type="checkbox"/>	white mat	L: 1296 mm	<input type="checkbox"/>	NW	4000 K	88 LEDs	2980 lm	34,40 W	59,95 €
730425	<input type="checkbox"/>	white mat	L: 1598 mm	<input type="checkbox"/>	NW	4000 K	108 LEDs	3820 lm	43,60 W	74,95 €

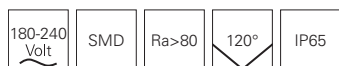

accessories

930071	wire suspension 2 pcs. L: 2500 mm	13,95 €
930072	mounting fixation 2 pcs.	13,95 €

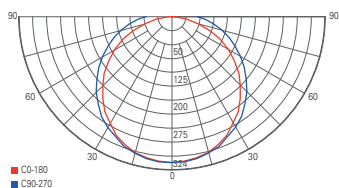

light distribution curve 730419

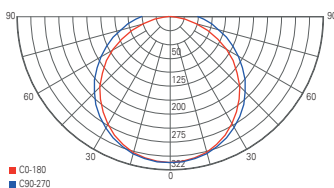

light distribution curve 730424

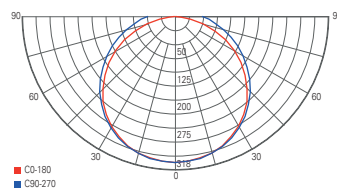

light distribution curve 730425

TRI PROOF MOTION

The ideal luminaire for environments with increased lighting requirements: whether in the garage, in the cellar or for the carport – the surface-mounted TRI PROOF MOTION luminaire is protected against wind and weather thanks to IP65 certification and is of course equipped with an integrated, invisible motion sensor that can be adjusted via dip switch.



TRI PROOF MOTION

- plastic
- dimensions L x W x H: 665 x 61 x 56 mm
- motion sensor
- incl. 2 mountings clips

730450 white mat nw 4000 K 1900 lm **49,95 €**

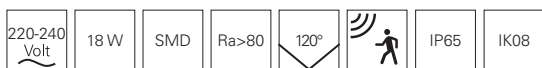

accessories

930071 wire suspension 2 pcs. | L: 2500 mm

13,95 €

930072 mounting fixation 2 pcs.

13,95 €

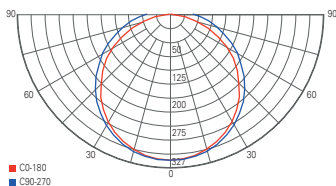

light distribution curve 730450



TRI PROOF MOTION

- plastic
- dimensions L x W x H: 1145 x 61 x 56 mm
- motion sensor
- incl. 2 mountings clips

730455 white mat nw 4000 K 2500 lm **59,95 €**

220-240 Volt	24 W	SMD	Ra>80	120°		IP65	IK08
--------------	------	-----	-------	------	--	------	------



accessories

930071 wire suspension 2 pcs. | L: 2500 mm

13,95 €

930072 mounting fixation 2 pcs.

13,95 €

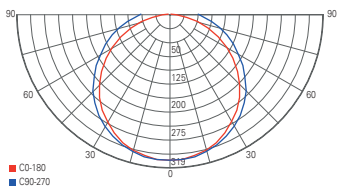

light distribution curve 730455



SYRMA OVAL

- plastic
- dimensions L x W x H: 180 x 125 x 105 mm
- socket L x W x H: 155 x 125 x 35 mm

401011	<input type="checkbox"/>	white	7,95 €
401013	<input type="checkbox"/>	grey	7,95 €
401012	<input type="checkbox"/>	black	7,95 €



suitable illuminants on page 974-977



SYRMA RUND

- plastic
- dimensions H x Ø: 110 x 190 mm
- socket H x Ø: 35 x 160 mm

401014	<input type="checkbox"/>	white	9,95 €
401016	<input type="checkbox"/>	grey	9,95 €
401015	<input type="checkbox"/>	black	9,95 €



suitable illuminants on page 974-977





□ ■ □
page 586



□ ■ □
page 587



□ ■ □
page 587



■
page 588



■
page 588



■
page 589



■
page 590



■
page 591



■ □
page 592



■ □
page 593



■ □
page 594



■ □
page 595



floodlights





FLOOD SMD

- aluminium diecast
- dimensions L x B x H: 170 x 144 x 27 mm
- socket L x B: 179 x 20 mm
- inkl. 1 m connection cable with IP44 plug

732027	silver coloured	3000 K	1325 lm	49,95 €
732028	silver coloured	4000 K	1349 lm	49,95 €
732029	black	3000 K	1325 lm	49,95 €

220-240 Volt	15 W	SMD	16 LED	Ra>80	100°	IP65/IP44	IK08
--------------	------	-----	--------	-------	------	-----------	------

suitable outdoor mounting material from page 1003
 suitable energy distributors/plug-in socket towers on page 388

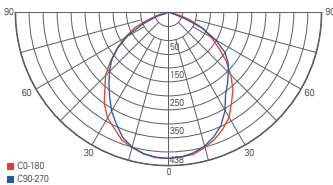

light distribution curve 732027

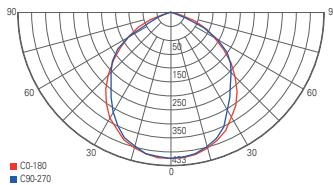

light distribution curve 732028

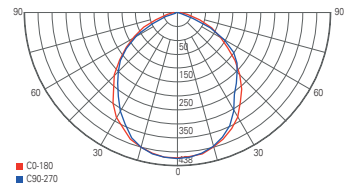

light distribution curve 732029





FLOOD SMD I

- aluminium diecast
- dimensions L x B x H: 230 x 192,5 x 40,5 mm
- socket L x B: 237 x 25 mm
- inkl. 1 m connection cable with IP44 plug

732012	<input type="checkbox"/>	silver coloured	<input type="checkbox"/>	3000 K	2600 lm	102,95 €
732025	<input type="checkbox"/>	silver coloured	<input type="checkbox"/>	4000 K	2650 lm	102,95 €
732030	<input checked="" type="checkbox"/>	black	<input type="checkbox"/>	3000 K	2600 lm	102,95 €

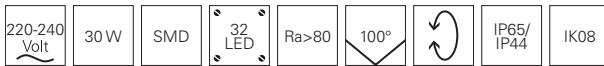

suitable outdoor mounting material from page 1003
 suitable energy distributors/plug-in socket towers on page 388



FLOOD SMD II

- aluminium diecast
- dimensions L x B x H: 290 x 244 x 40,5 mm
- socket L x B: 302 x 30 mm
- inkl. 1 m connection cable with IP44 plug

732013	<input type="checkbox"/>	silver coloured	<input type="checkbox"/>	3000 K	4130 lm	159,95 €
732026	<input type="checkbox"/>	silver coloured	<input type="checkbox"/>	4000 K	4190 lm	159,95 €
732031	<input checked="" type="checkbox"/>	black	<input type="checkbox"/>	3000 K	4130 lm	159,95 €

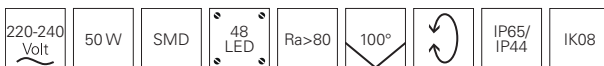

suitable outdoor mounting material from page 1003
 suitable energy distributors/plug-in socket towers on page 388

FLOOD COB 30 AMBER

- aluminium diecast / plastic
- dimensions L x B x H: 178 x 81 x 215 mm
- inkl. 1m connection cable with IP44 plug

730464 ■ anthracite **A** 1700 K 710 lm **199,95 €**



suitable outdoor mounting material from page 1003
suitable energy distributors/plug-in socket towers on page 388

accessories

930007 Display-Arm | L: 550 mm | grau **48,95 €**

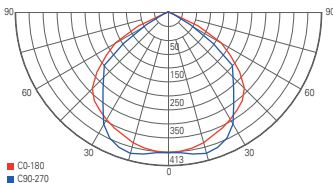

light distribution curve

FLOOD COB 50 AMBER

- aluminium diecast / plastic
- dimensions L x B x H: 200 x 98 x 253 mm
- inkl. 1m connection cable with IP44 plug

730465 ■ anthracite **A** 1700 K 1255 lm **299,95 €**



suitable outdoor mounting material from page 1003
suitable energy distributors/plug-in socket towers on page 388

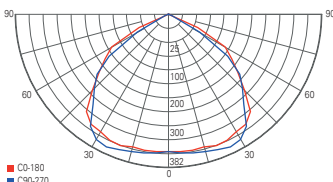

light distribution curve

FLOOD COB 80 AMBER

- aluminium diecast / plastic
- dimensions L x B x H: 291 x 250 x 116 mm
- inkl. 1m connection cable with IP44 plug

730466 ■ anthracite **A** 1700 K 1285 lm **399,95 €**



suitable outdoor mounting material from page 1003
suitable energy distributors/plug-in socket towers on page 388

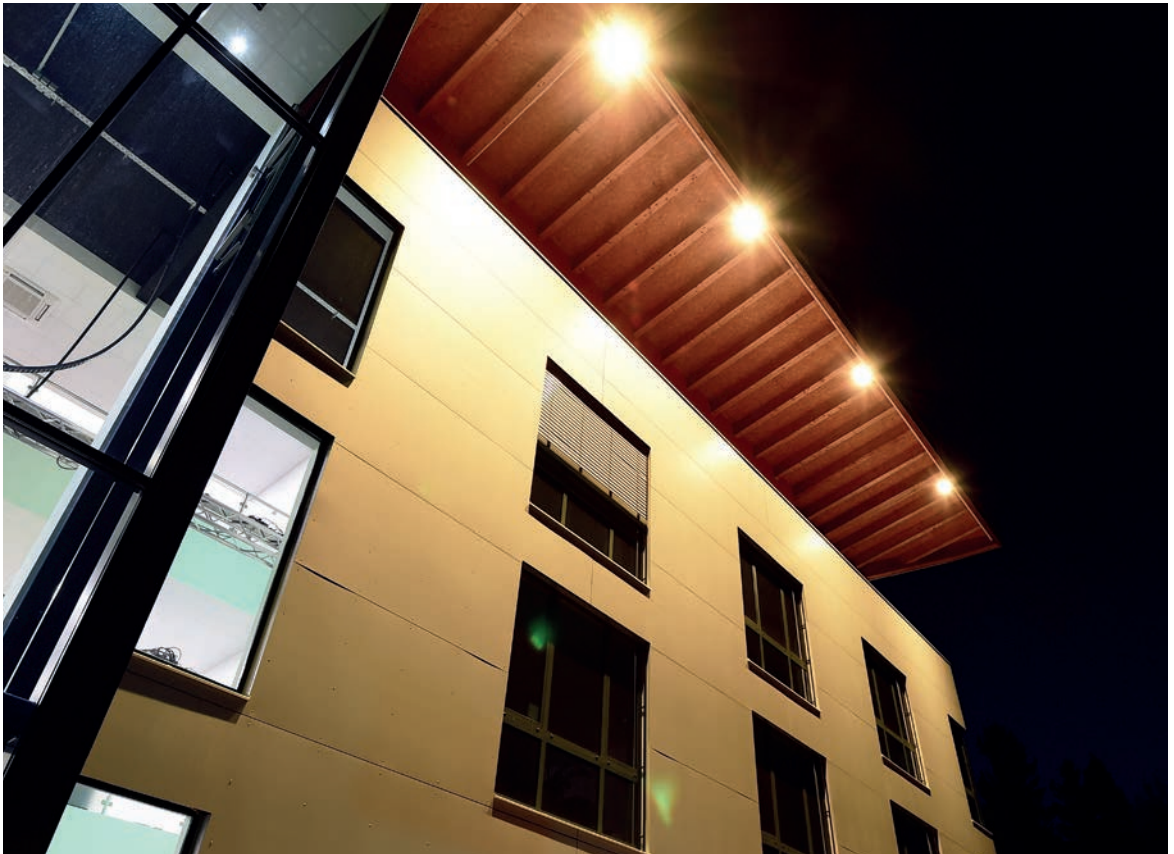
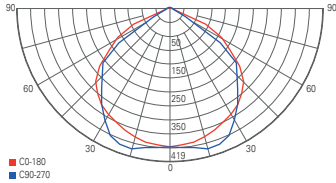



BRACHIUM

- aluminium diecast
- dimensions L x B x H: 316 x 286 x 41mm
- socket L x B x H: 327 x 28 x 160 mm
- inkl. 2 m connection cable with IP44 plug

732064	■ black	■ WW 3000 K	8100 lm	249,95 €
732105	■ black	■ NW 4000 K	8400 lm	249,95 €

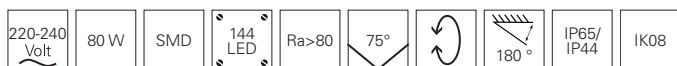

suitable outdoor mounting material from page 1003
 suitable energy distributors/plug-in socket towers on page 388

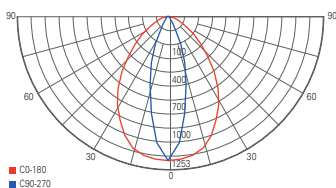
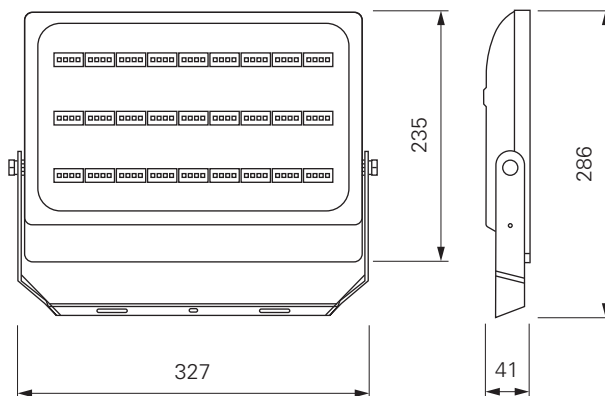

light distribution curve 732064

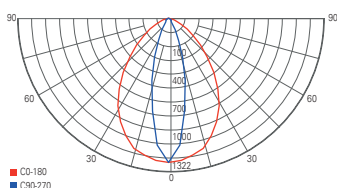

light distribution curve 732105



BRACHIUM

- aluminium diecast
- dimensions L x B x H: 316 x 286 x 41mm
- socket L x B x H: 327 x 28 x 160 mm
- inkl. 2 m connection cable with IP44 plug

732106	■ black	■ ww 3000 K	8600 lm	279,95 €
732107	■ black	■ nw 4000 K	9200 lm	279,95 €

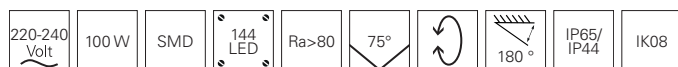

suitable outdoor mounting material from page 1003
 suitable energy distributors/plug-in socket towers on page 388

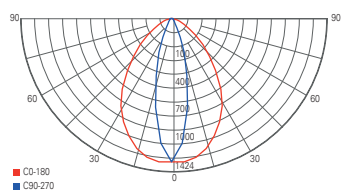
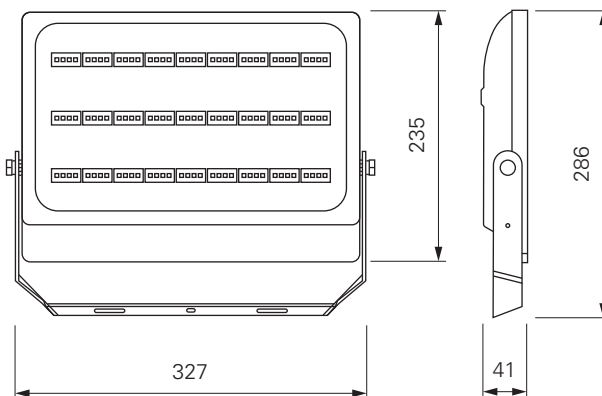

light distribution curve 732106

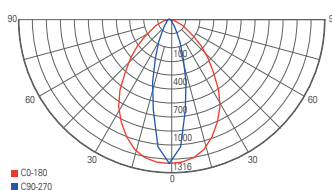

light distribution curve 732107



ATIK

- aluminium diecast
- dimensions L x B x H: 319 x 90 x 411 mm
- inkl. 2 m connection cable with IP44 plug

732041	■ Jet black RAL 9005	■ ww 3000 K	17500 lm	339,95 €
732096	■ Jet black RAL 9005	■ nw 4000 K	21350 lm	339,95 €
732099	■ Jet black RAL 9005	■ cw 5000 K	20500 lm	339,95 €

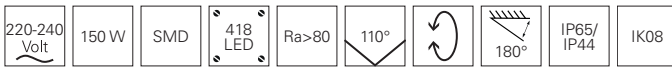

accessories

930411 protective grid metal | black | 57 mm **9,95 €**

suitable outdoor mounting material from page 1003
 suitable energy distributors/plug-in socket towers on page 388

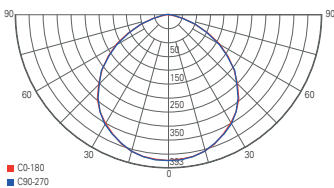
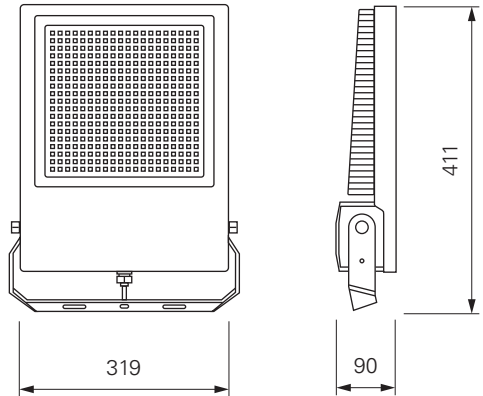

light distribution curve 732041

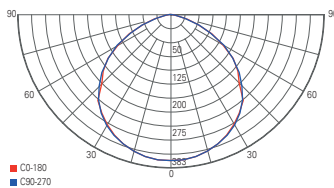

light distribution curve 732096

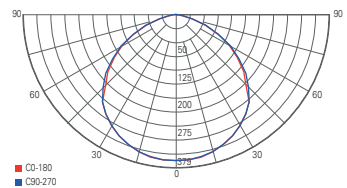

light distribution curve 732099



ATIK

- aluminium diecast
- dimensions L x B x H: 319 x 90 x 411 mm
- inkl. 2 m connection cable with IP44 plug

732043	■ Jet black RAL 9005	■ WW 3000 K	24200 lm	439,95 €
732097	■ Jet black RAL 9005	■ NW 4000 K	28450 lm	439,95 €
732100	■ Jet black RAL 9005	■ CW 5000 K	27400 lm	439,95 €

220-240 Volt	200 W	SMD	320 LED	Ra>80	110°	180°	IP65/ IP44	IK08
--------------	-------	-----	---------	-------	------	------	------------	------

accessories

930411 protective grid metal | black | 57 mm **9,95 €**

suitable outdoor mounting material from page 1003
 suitable energy distributors/plug-in socket towers on page 388

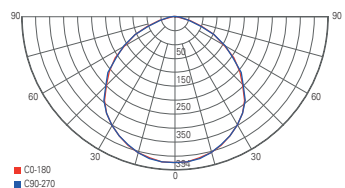
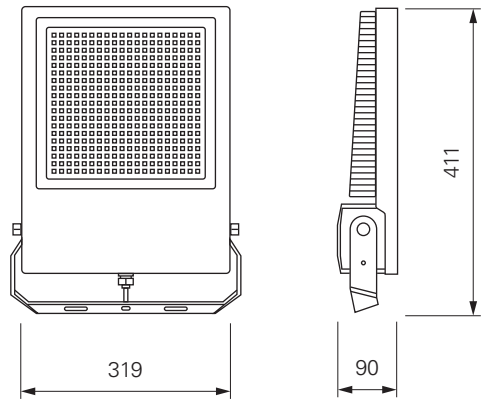

light distribution curve 732043

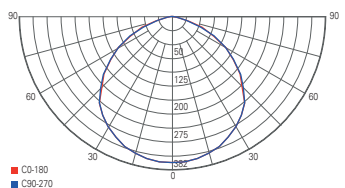

light distribution curve 732097

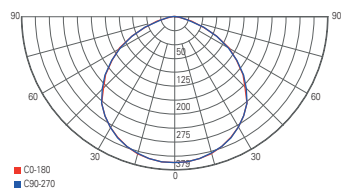

light distribution curve 732100



ATIK

- aluminium diecast
- dimensions L x B x H: 319 x 90 x 411 mm
- inkl. 2 m connection cable with IP44 plug

732045	■ Jet black RAL 9005	■ ww 3000 K	26900 lm	499,95 €
732098	■ Jet black RAL 9005	■ nw 4000 K	31800 lm	499,95 €
732101	■ Jet black RAL 9005	■ cw 5000 K	31050 lm	499,95 €

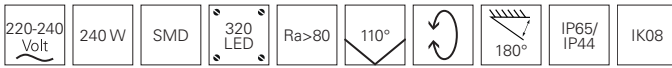

accessories

930410	anti-dazzle device black 122 mm	24,95 €
930411	protective grid metal black 57 mm	9,95 €

suitable outdoor mounting material from page 1003
 suitable energy distributors/plug-in socket towers on page 388

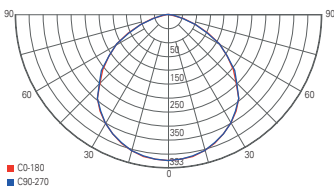
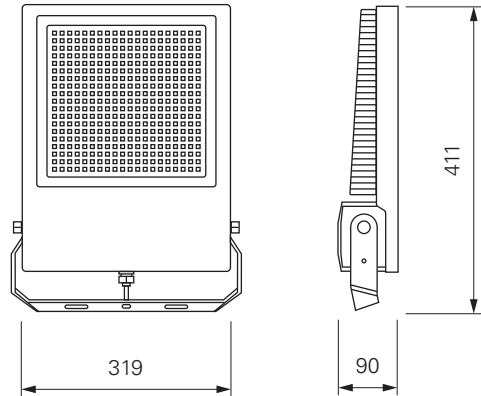

light distribution curve 732045

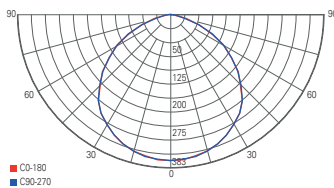

light distribution curve 732098

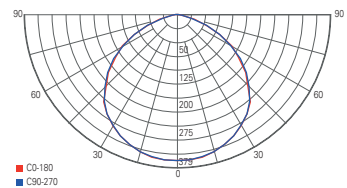

light distribution curve 732101



ATIK

- aluminium diecast
- dimensions L x B x H: 319 x 90 x 411 mm
- inkl. 2 m connection cable with IP44 plug

732102	■ Jet black RAL 9005	NW 4000 K	39900 lm	579,95 €
732103	■ Jet black RAL 9005	CW 5000 K	39900 lm	579,95 €

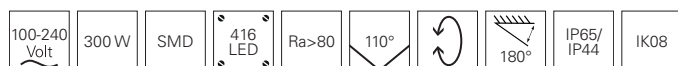

accessories

930410	anti-dazzle device black 122 mm	24,95 €
930411	protective grid metal black 57 mm	9,95 €

suitable outdoor mounting material from page 1003
 suitable energy distributors/plug-in socket towers on page 388

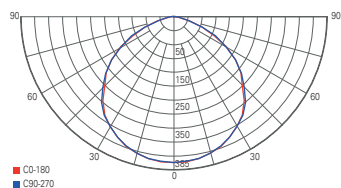
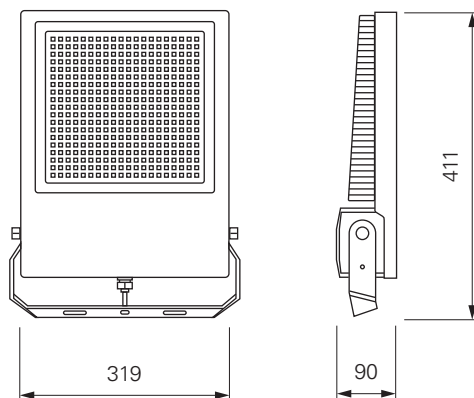

light distribution curve 732102

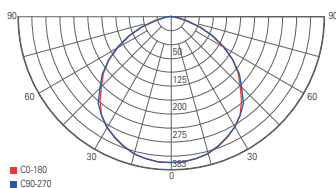

light distribution curve 732103



□ ■
page 598



■ □
page 298



■
page 299



display lights





ATIS II

- exclusive design
- aluminium diecast
- dimensions L x W: 526 x 144 mm
- socket H x Ø: 40 x 95 mm
- dimmable via leading or trailing edge

688020	□	Signal white RAL 9003	☀	3000 K	1120 lm	185,95 €
688021	■	Black grey RAL 7021	☀	3000 K	1120 lm	185,95 €

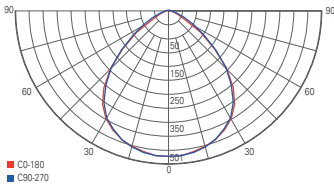
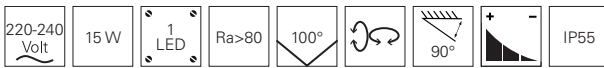

light distribution curve 688020

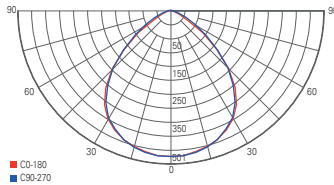

light distribution curve 688021



KEID

- aluminium diecast
- dimensions L x H x Ø: 120 x 580 x 75 mm
- socket H x Ø: 37 x 99 mm

688019	■	dark grey	☀	3000 K	10 W	800 lm	149,95 €
688024	■	dark grey	☀	3000 K	20 W	1350 lm	159,95 €

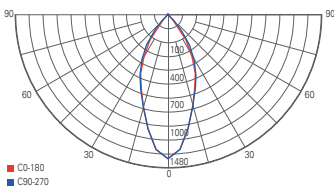

light distribution curve 688019

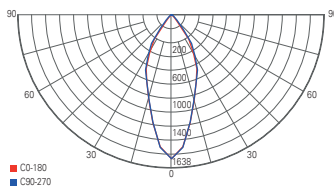

light distribution curve 688024



MOBBY II

- aluminium diecast
- dimensions L x H x Ø: 680 x 100 x 84 mm
- socket H x Ø: 34 x 95 mm
- dimmable via leading or trailing edge

688008 ■ Black grey RAL 7021 ww 3000 K 810 lm **169,95 €**

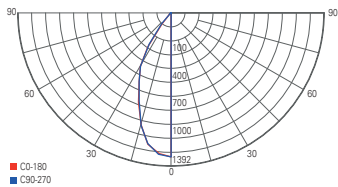
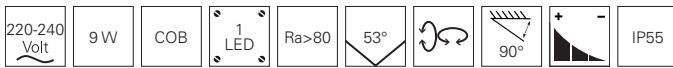

light distribution curve





page 602



page 603



page 604



page 606



effect lights



MAIA

Futuristic lines on walls and ceilings – the effect luminaires of the MAIA series based on SMD LEDs produce a warm white line light. Both models set visual accents and emphasise the surrounding architecture. Thanks to its slim and elegant shape, the IP65-certified MAIA series can be flexibly integrated not only in outdoor areas but also in indoor areas.



MAIA I

- aluminium diecast
- dimensions L x H x Ø: 110 x 170 x 119 mm
- socket H x Ø: 45 x 110 mm
- dimmable via leading or trailing edge

731104 Pure white RAL 9010  3000 K 100 lm **189,95 €**

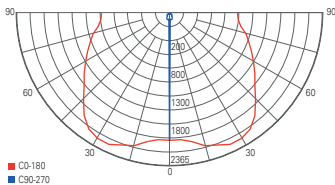
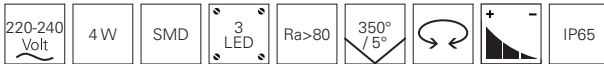

light distribution curve





MAIA II

- aluminium diecast
- dimensions L x W x H: 148,00 x 60,60 x 98,50 mm
- socket L x W: 148 x 60,60 mm
- dimmable via leading or trailing edge

731105 Pure white RAL 9010 3000 K 70 lm **189,95 €**

220-240 Volt	4 W	SMD	3 LED	Ra>80	180° / 5°		IP65
-----------------	-----	-----	----------	-------	--------------	--	------

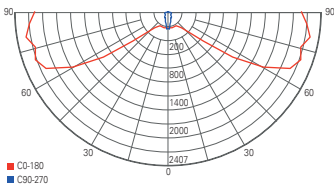

light distribution curve

With the kind support of WIBU-SYSTEMS AG Karlsruhe



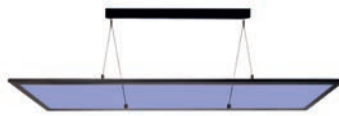
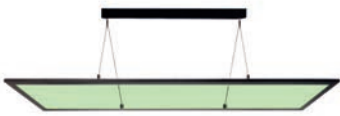
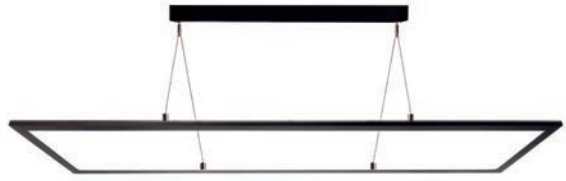

LED EVENT-PANEL TRANSPARENT RGBNW

- aluminium
- dimensions L x W x H: 1195 x 295 x 14 mm
- dimmable via optional controller

620032	<input type="checkbox"/>	white clear / transparent	 	4000 K	4265 lm	235,95 €
620031	<input type="checkbox"/>	black clear / transparent	 	4000 K	4265 lm	235,95 €

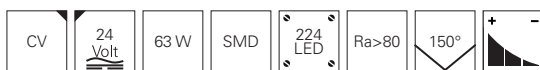

optional accessories

862164	power supply 24V DC 75,0 W	74,95 €
843059	RF controller set RGB+white 12/24/48V	109,95 €
843010	DALI LED PWM dimmer 4 channel	114,95 €
843000	DMX controller Art-4	189,95 €
843269	DMX dimmer OLED dimmer 4	99,95 €
843053	Quasar PWM-easy	119,95 €

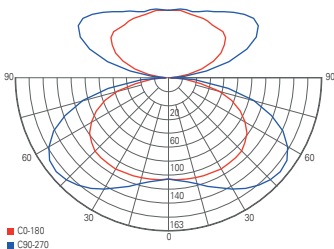

light distribution curve





STUDIO PAR 30

- aluminium
- dimensions L x W: 220 x 97,45 mm
- socket L x W x H: 133 x 130 x 3 mm
- dimmable via optional illuminants

001248  silver coloured chrome

31,95 €

001247  black

31,95 €



suitable illuminants on page 973-975





☐☐
page 610



☐
page 610



☐☐
page 611



☐☐
from page 612



☐☐
from page 614



emergency lights



EMERGENCY LIGHT ALMAAZ CONE

- plastic
- dimensions L x W x H: 283 x 50 x 187 mm
- single battery technology with LiFePO4 battery
- detection range 27m
- SK II / III with INSiLIA technology
- luminance 500cd/m²
- autotest function with buzzer
- rotatable housing for ceiling or wall mounting
- incl. changeable pictogram set in all directions

348152 white NW 4500 K

169,95 €

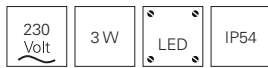

optional accessories

- 930632** special pictogram First Aid Box | green
- 930633** special pictogram fire extinguisher | red
- 930634** battery bar | 3,2V | 1500mAh

99,95 €

99,95 €

42,95 €



EMERGENCY LIGHT ALSAFI

- plastic
- dimensions L x W x H: 360 x 88 x 118 mm
- single battery technology with LiFePO4 battery
- detection range 16m
- SK II / III with INSiLIA technology
- luminance 500cd/m²
- autotest function with buzzer
- cut-outs for pendant mounting
- reflector with hinges
- suitable for ceiling or wall mounting
- incl. changeable pictogram set in all directions

348140 white NW 4500 K

155,95 €

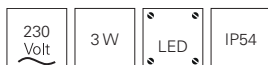

optional accessories

- 930634** battery bar | 3,2V | 1500mAh

42,95 €



EMERGENCY LIGHT ALMAAZ FLAT

- plastic
- dimensions L x W x H: 283 x 50 x 198 mm
- single battery technology with LiFePO4 battery
- detection range 27m
- SK II / III with INSILIA technology
- DIP-Schater zur Umschaltung von 3 auf 8h
- luminance 500cd/m²
- autotest function with buzzer
- rotatable housing for ceiling or wall mounting
- incl. changeable pictogram set in all directions



348151 white NW 4500 K

245,95 €



optional accessories

- 930632** special pictogram First Aid Box | green
- 930633** special pictogram fire extinguisher | red
- 930634** battery bar | 3,2V | 1500mAh

99,95 €

99,95 €

42,95 €



EMERGENCY LIGHT ALMACH FOR THE ILLUMINATION OF CORRIDORS

- Red Dot Award Winner 2017
- special lens for the illumination of escape routes or for area lighting
- plastic
- dimensions L x W x H: 192 x 101 x 57 mm
- single battery technology with LiFePO4 battery
- SK II / III with INSiLIA technology
- 3h/8h bridging time
- simple click mounting
- rotatable



731142 white nw 4500 K **225,95 €**

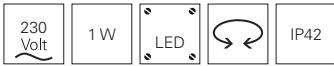

PHOTOMETRIC DATA

mounting height	a		b				c		d		c		d	
	1 W	2 W	1 W	2 W	1 W	2 W	1 W	2 W	1 W	2 W	1 W	2 W		
	area lighting						emergency exit lens							
2,5 m	3,50	3,92	7,84	8,84	2,72	3,03	6,05	7,00	5,02	5,77	11,54	13,46		
3,0 m	3,78	4,37	9,09	9,82	3,05	3,52	6,79	7,83	5,55	6,33	12,65	14,60		
3,5 m	3,97	4,93	9,85	11,04	3,33	3,83	7,66	8,52	5,98	7,07	14,15	16,26		
4,0 m	3,81	5,24	10,48	12,16	3,56	4,09	8,18	9,41	6,32	7,75	15,50	17,74		
4,5 m	-	5,50	10,99	13,19	3,73	4,45	8,90	10,24	6,12	8,37	16,74	19,09		
5,0 m	-	5,50	11,00	14,14	3,87	4,62	9,56	11,00	-	8,57	-	20,30		
5,5 m	-	-	-	15,00	-	4,91	-	11,69	-	8,72	-	21,39		
6,0 m	-	-	-	15,23	-	5,17	-	12,32	-	8,82	-	22,38		
6,5 m	-	-	-	15,37	-	5,41	-	12,90	-	8,56	-	23,27		
7,0 m	-	-	-	15,99	-	5,43	-	13,42	-	-	-	-		
7,5 m	-	-	-	15,98	-	5,61	-	13,89	-	-	-	-		

EMERGENCY LIGHT ALMACH FOR THE ILLUMINATION OF AREAS

- Red Dot Award Winner 2017
- special lens for the illumination of escape routes or for area lighting

- plastic
- dimensions L x W x H: 192 x 101 x 57 mm
- single battery technology with LiFePO4 battery
- SK II / III with INSILIA technology
- 3h/8h bridging time
- simple click mounting
- rotatable

731143 white **nw** 4500 K **225,95 €**

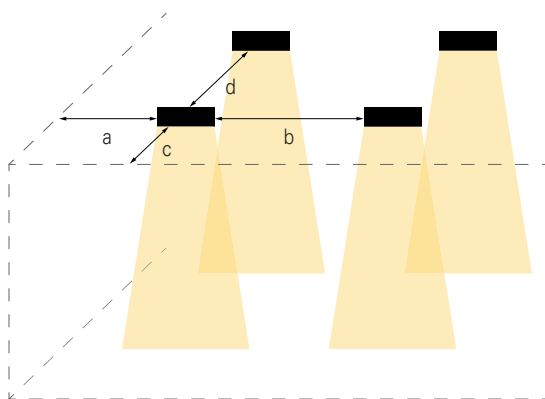
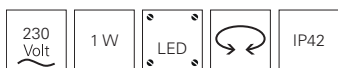

- a: distance from luminaire [narrow page] to wall
 b: distance from luminaire [narrow page] to luminaire [narrow page]
 c: distance from luminaire [long page] to wall
 d: distance from luminaire [long page] to luminaire [long page]



EMERGENCY LIGHT ALNAIR FOR THE ILLUMINATION OF AREAS

- **special lens for the illumination of escape routes or for area lighting**

- plastic
- dimensions H x Ø: 28 x 78 mm
- single battery technology with LiFePO4 battery
- SK II / III with INSiLIA technology
- 3h/8h bridging time

565326 white nw 4500 K **239,95 €**



PHOTOMETRIC DATA

mounting height	a		b				c		d		c		d	
	1 W	2 W	1 W	2 W	1 W	2 W	1 W	2 W	1 W	2 W	1 W	2 W	1 W	2 W
2,5 m	3,57	4,00	8,00	9,02	2,68	3,09	6,17	7,14	5,13	5,62	11,78	13,74		
3,0 m	3,84	4,45	9,24	9,99	3,11	3,45	6,90	7,96	5,64	6,43	12,87	14,85		
3,5 m	3,89	5,00	10,00	11,20	3,38	3,89	7,77	8,64	6,06	7,18	14,35	15,72		
4,0 m	3,73	5,13	10,62	12,32	3,48	4,14	8,28	9,53	6,16	7,85	15,70	17,16		
4,5 m	2,00	5,56	11,11	13,34	3,78	4,50	9,00	10,35	-	8,12	-	19,30		
5,0 m	1,92	5,55	11,11	14,28	3,91	4,66	9,66	11,11	-	8,66	-	20,50		
5,5 m	-	5,50	-	14,60	-	4,95	-	11,80	-	8,80	-	21,59		
6,0 m	-	-	-	-	-	-	-	-	-	-	-	-		
6,5 m	-	-	-	-	-	-	-	-	-	-	-	-		
7,0 m	-	-	-	-	-	-	-	-	-	-	-	-		
7,5 m	-	-	-	-	-	-	-	-	-	-	-	-		



EMERGENCY LIGHT ALNAIR FOR THE ILLUMINATION OF CORRIDORS

• special lens for the illumination of escape routes
or for area lighting

- plastic
- dimensions H x Ø: 28 x 78 mm
- single battery technology with LiFePO4 battery
- SK II / III with INSILIA technology
- 3h/8h bridging time

565325 white **nw** 4500 K **239,95 €**

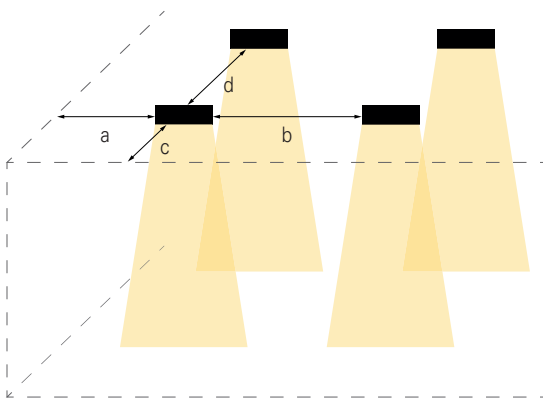
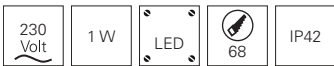

- a: distance from luminaire [narrow page] to wall
 b: distance from luminaire [narrow page] to luminaire [narrow page]
 c: distance from luminaire [long page] to wall
 d: distance from luminaire [long page] to luminaire [long page]



□ ■ ■ □
page 625



□ □
page 625



□ ■ ■
page 626



□ ■ ■
page 627



□ ■ ■
page 627



□ ■ ■
page 628



□ ■ ■
page 628



□ ■ ■
page 629



□ ■ ■
page 629



□ ■ ■
page 630



□ ■ ■
page 631



□ ■ ■
page 632



□ ■
page 633



□ ■ ■
page 633



□ ■ ■
page 634



□ ■ ■
page 634



□ ■ ■
page 635



□ ■ ■
page 635



□ ■ ■
page 636

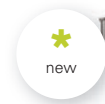

□ ■ ■
page 636



■
page 637



□
page 637



□ ■ ■
page 639



□ ■ ■
page 640



page 641



page 642



page 642



page 643

D LINE power rail system

D LINE MOUNTING POWER RAIL SYSTEM 3-PHASE 230V

mounting modules	illustr.	Traffic white	Window grey	Graphite black	page
mounting power rail L: 1000 mm	01	710000	710001	710002	625
mounting power rail L: 2000 mm	01	710003	710004	710005	625
mounting power rail L: 3000 mm	01	710006	710007	710008	625
mounting adapter for lights	02	710045	710046	710047	626
live end feeder left	03	710009	710010	710011	627
live end feeder right	04	710012	710013	710014	627
electrical straight connector with center feed option	05	710042	710043	710044	628
flexible-connector left-right	06	710039	710040	710041	628
electrical joint	07	710015	710016	710017	629
mechanical joint	08	710018	710019	710020	629
90°-joint left-right with exchange mechanism	09	710036	710037	710038	630
T-joint left-left-right with exchange mechanism	10	710027	710028	710029	631
T-joint right-right-left with exchange mechanism	11	710030	710031	710032	631
X-joint left-left-right-right	12	710033	710034	710035	632
cover plate built in track	13	710077	-	710079	633
endcap	14	710066	710067	710068	633
ceiling mounting bracket flex	15	710063	710064	710065	634
suspension clamp for track connection	16	710057	710058	710059	634
ceiling suspension rigid [635 mm] with canopy	17	710078	710085	710084	635
extension for ceiling suspension [300 mm]	17	710086	710088	710087	635
wire suspension bracket with ceiling rosette 1500 mm	18	710048	710049	710050	636
rope suspension bracket Mini mit Abhängeseil 5000 mm	19	710094	710095	710096	636
quick mounting bracket for grid ceilings	20	710051	710052	710053	639
truss adapter silver coloured	21	-	710083	-	637
quick mounting clamp for exhibition stand construction	22	-	-	710082	637
3-circuits adapter for light installation	23	710021	710022	710023	640
3-circuits adapter with Multi CC power supply 250/350/450/500 mA 6,30 - 21,00 W 25-42V	24	862180	-	862183	641
3-circuits adapter with Multi CC power supply 600/700/750/800 mA 15,00 - 33,60 W 25-42V	24	862181	-	862184	641
3-circuits adapter with Multi CC power supply 850/900/950/1050 mA 23,00 - 44,10 W 27-42V	24	862182	-	862185	641
electrical outlet adapter	25	710024	-	710026	642
mounting adapter for additional components max. 10kg	26	710054	710055	710056	642
signs hook	27	710060	710061	710062	643

ILLUSTRATIONS WITH PLANNING RELEVANT DIMENSIONS

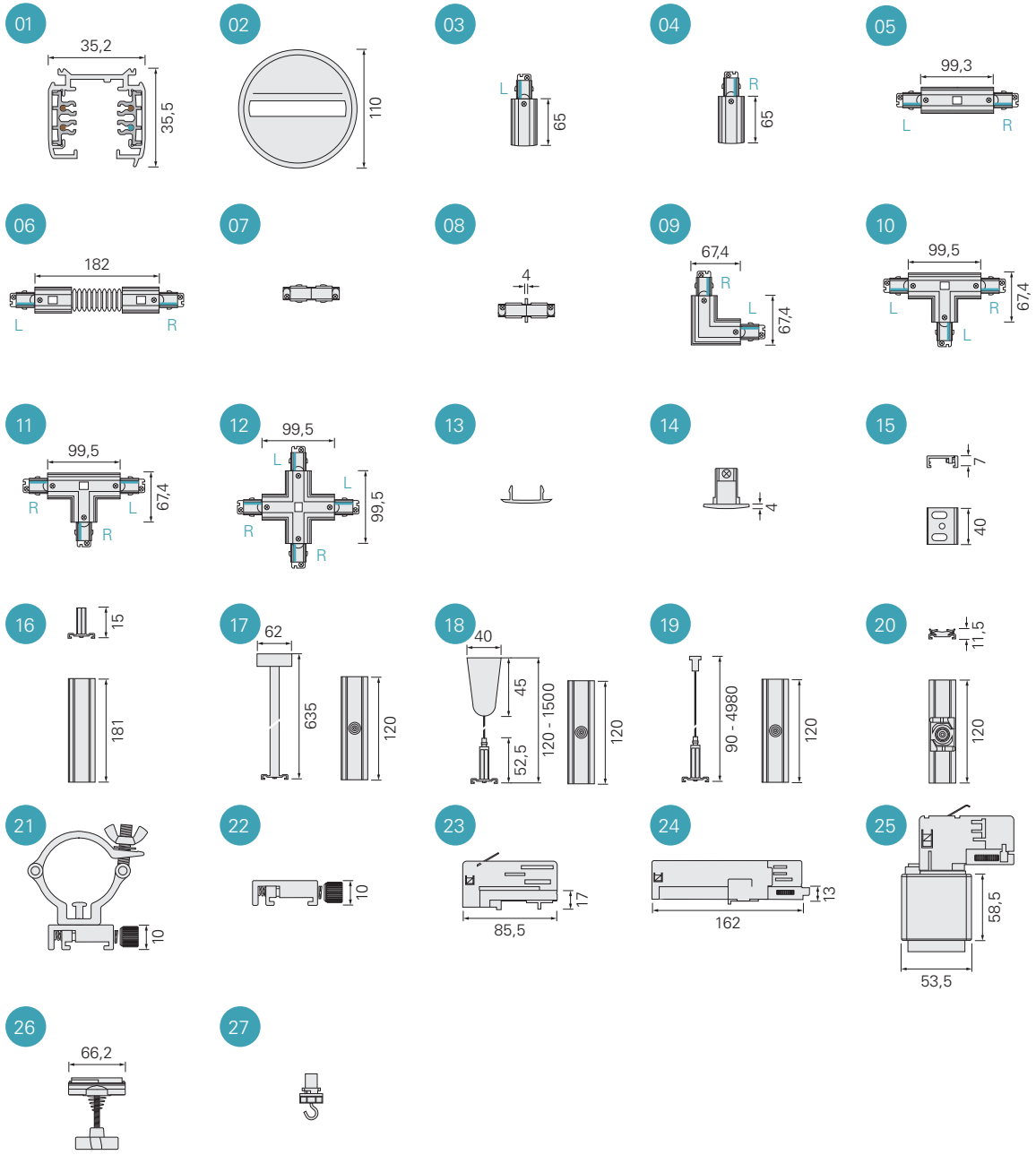

D LINE BUILT IN POWER RAIL SYSTEM 3-PHASE 230V

	illustr.	Traffic white	illustr.	cover	page
built in modules					
built in power rail L: 1000 mm	01	710069		-	625
built in power rail L: 2000 mm	01	710070		-	625
built in power rail L: 3000 mm	01	710071		-	625
live end feeder left	02	710009	18	710089	627
live end feeder right	03	710012	18	710089	627
electrical straight connector with center feed option	04	710042	19	710090	628
electrical joint	05	710015		-	629
mechanical joint	06	710018		-	629
90°-joint left-right	07	710036	20	710091	630
T-joint left-left-right	08	710027	21	710093	631
T-joint right-right-left	09	710030	21	710093	631
X-joint left-left-right-right	10	710033	22	710092	632
cover plate built in track	11	710077			633
endcap	12	710066		-	633
3-circuits adapter for light installation	13	710021		-	640
3-circuits adapter with Multi CC power supply 250/350/450/500 mA 6,30 - 21,00 W 25-42V	14	862180			641
3-circuits adapter with Multi CC power supply 600/700/750/800 mA 15,00 - 33,60 W 25-42V	14	862181			641
3-circuits adapter with Multi CC power supply 850/900/950/1050 mA 23,00 - 44,10 W 27-42V	14	862182			641
electrical outlet adapter	15	710024		-	642
mounting adapter for additional components max. 10kg	16	710054		-	642
signs hook	17	710060		-	643



Unlike other systems, you will not need any additional or special electrical components such as feeders, connectors, corners or T-connectors for the recessed tracks in the future. All standard components of the system are used and only the matching plastic cover is exchanged, and the recessed version is ready. This simplifies stock-keeping and gives significantly more flexibility here as well.

ILLUSTRATIONS WITH PLANNING RELEVANT DIMENSIONS

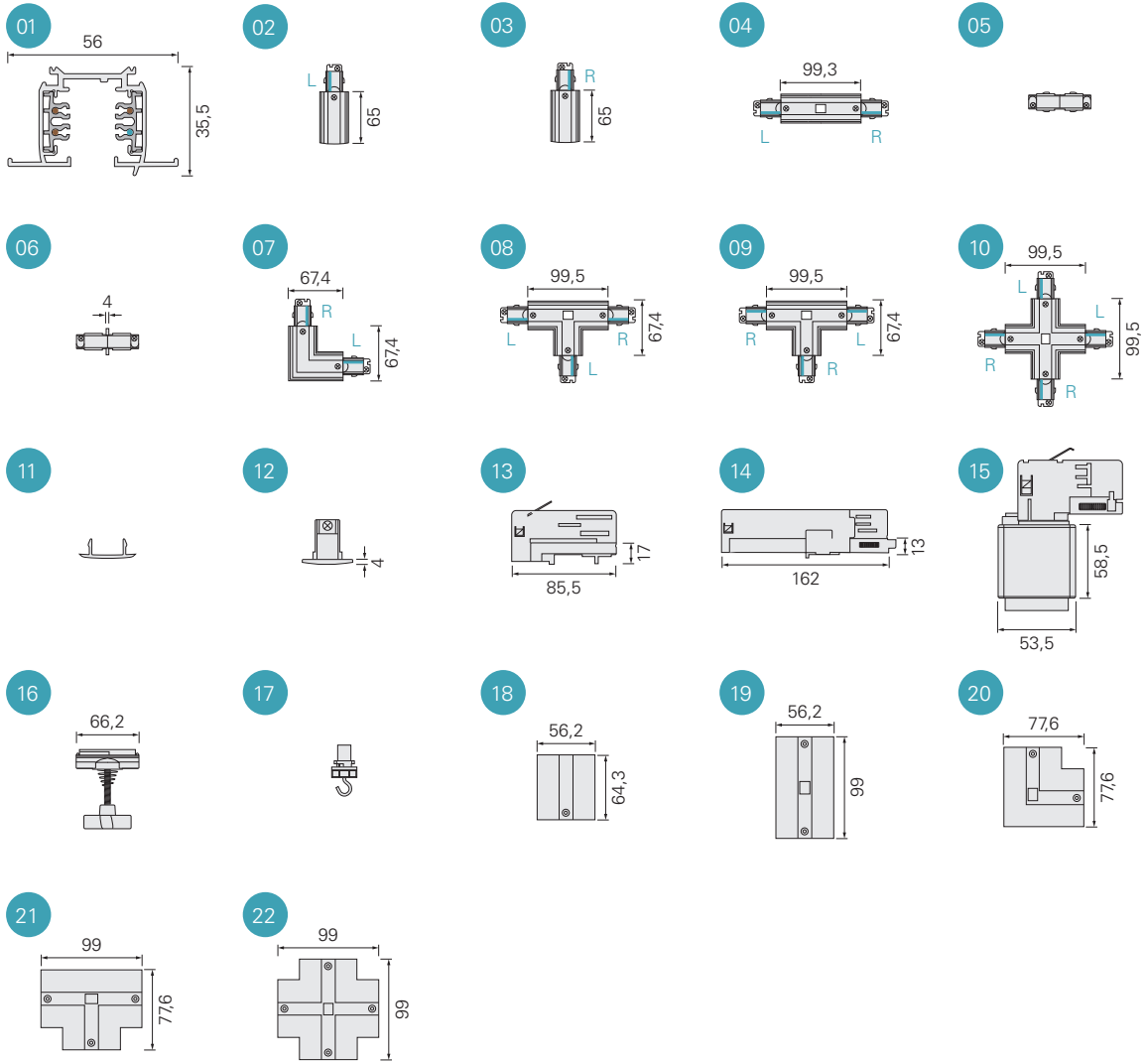

FIXING POINTS

power rail	a	b	c	d
1000 mm	125 mm			
2000 mm	125 mm	998 mm		
3000 mm	125 mm		914 mm	1167 mm

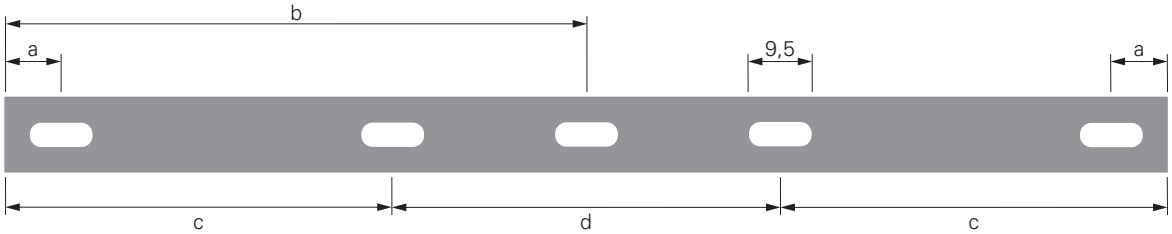

MECHANICAL LOAD TRACK POWER RAIL 1000 MM

50 N $\hat{=}$ 5,09 kg
dimension in mm

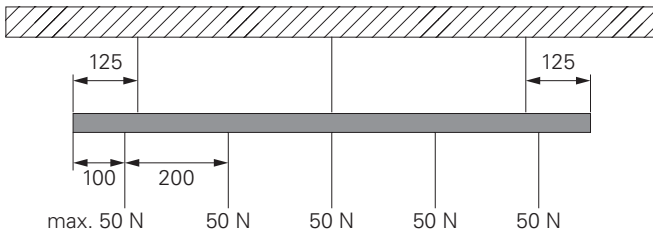

MECHANICAL LOAD TRACK POWER RAIL 2000/3000 MM

50 N $\hat{=}$ 5,09 kg
dimension in mm

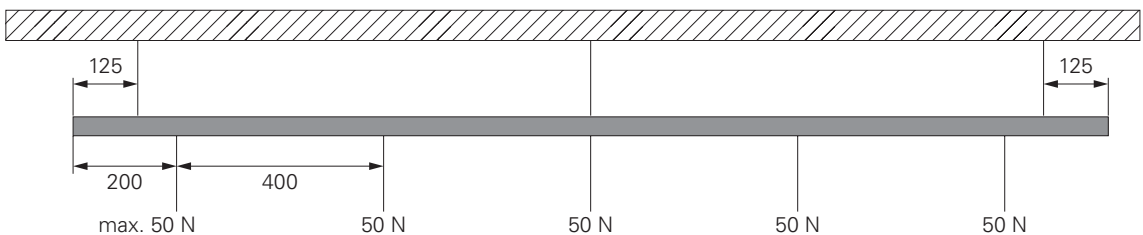

PLANNING GUIDE D LINE TRACK SYSTEM 3-PHASE 230V

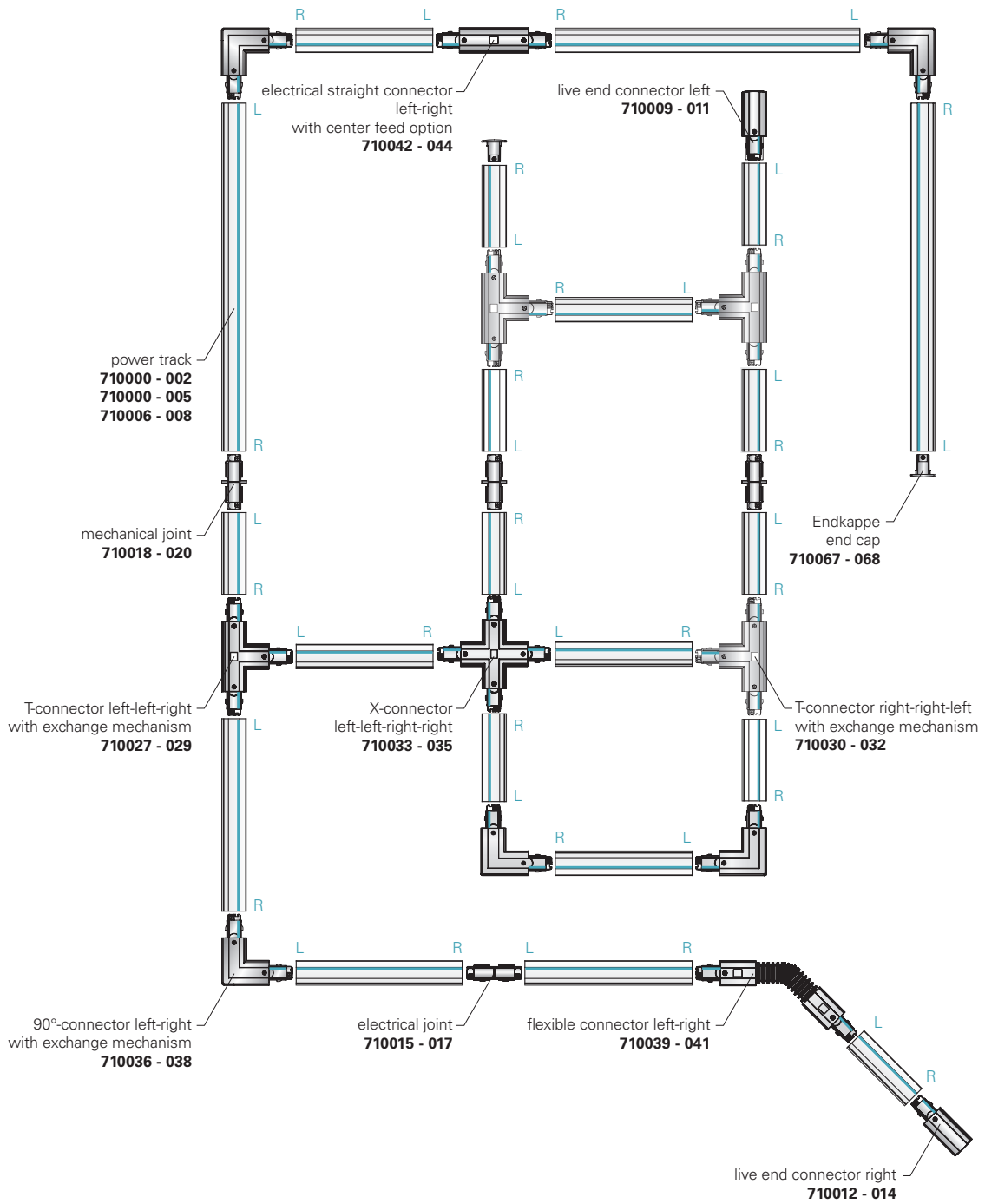
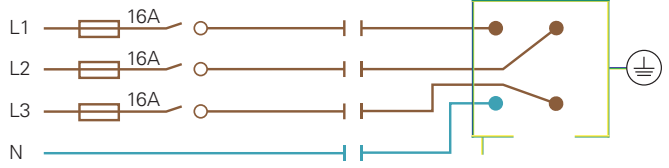
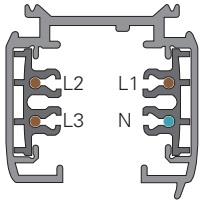

D LINE POWER RAIL SYSTEM 3-PHASE 230V

The new D LINE track system is available exclusively from DEKO-LIGHT and is extremely easy to plan and install thanks to its components, some of which have been completely redesigned. It is also compatible with all common track adapters and luminaires. The elegant and timeless design is available in white, black and grey, and the wide range

of accessories and mounting components means that there are no limits to its use and installation. Thanks to the new interchangeable mechanism of the 90° and T connectors, planning is easier than ever before and the installation of even complex shapes will be child's play in the future.

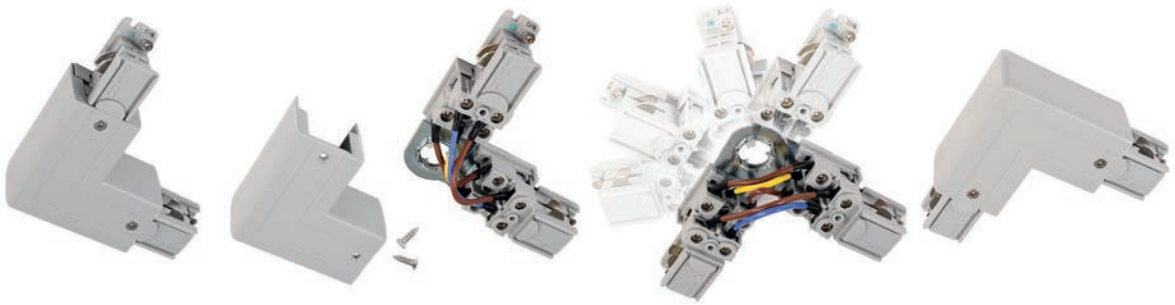

COMPATIBILITY OVERVIEW

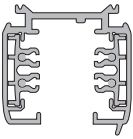
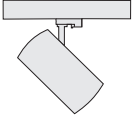
power rail	luminaires and power rail adapters from:						
D LINE	D LINE	Global	Ivela	Erco	Hoffmeister	Zumtobel/ Staff	Eutrac
	compatible	compatible	compatible	compatible	compatible	compatible	compatible
luminaires	3-phase power rail from:						
DEKO-LIGHT	D LINE	Global	Ivela	Erco	Hoffmeister	Zumtobel/ Staff	Eutrac
	compatible	compatible*	compatible*	compatible*	compatible*	compatible*	compatible*

*compatible with all DEKO-LIGHT 3-phase spotlights, except AIN series [p. 649] and 3-phase adapter with integrated multi-CC power supply unit [p. 641].

All data without guarantee. Technical data and dimensions are subject to change without prior notice. Check against samples when planning a project to ensure functionality.



D LINE MOUNTING POWER RAIL

- aluminium
- dimensions W x H: 35,20 x 35,50 mm
- 3-phase

710000	<input type="checkbox"/>	Traffic white RAL 9016	L: 1000 mm	34,95 €
710003	<input type="checkbox"/>	Traffic white RAL 9016	L: 2000 mm	69,95 €
710006	<input type="checkbox"/>	Traffic white RAL 9016	L: 3000 mm	104,95 €
710001	<input type="checkbox"/>	Window grey RAL 7040	L: 1000 mm	34,95 €
710004	<input type="checkbox"/>	Window grey RAL 7040	L: 2000 mm	69,95 €
710007	<input type="checkbox"/>	Window grey RAL 7040	L: 3000 mm	104,95 €
710002	<input type="checkbox"/>	Graphite black RAL 9011	L: 1000 mm	34,95 €
710005	<input type="checkbox"/>	Graphite black RAL 9011	L: 2000 mm	69,95 €
710008	<input type="checkbox"/>	Graphite black RAL 9011	L: 3000 mm	104,95 €



D LINE BUILT IN POWER RAIL WITH WINGS

- aluminium
- dimensions W x H: 56 x 35,50 mm
- 3-phase

710069	<input type="checkbox"/>	Traffic white RAL 9016	L: 1000 mm	41,95 €
710070	<input type="checkbox"/>	Traffic white RAL 9016	L: 2000 mm	79,95 €
710071	<input type="checkbox"/>	Traffic white RAL 9016	L: 3000 mm	118,95 €



On request, all D LINE busbars can be supplied ready-made and cut to size according to your specifications for a small surcharge. This allows you to start installation directly on site at the customer's premises. Please contact our sales department for more information.





With the surface-mounted adapter, every 3-phase track luminaire can be converted into a surface-mounted spotlight. This is often desired when ceiling spots scattered around the room are to match the design of the track spotlights.



D LINE MOUNTING ADAPTER FOR LIGHTS

- plastic
- dimensions H x Ø: 35 x 110 mm
- luminaire not included

710045	<input type="checkbox"/>	Traffic white RAL 9016	24,95 €
710046	<input type="checkbox"/>	Window grey RAL 7040	24,95 €
710047	<input type="checkbox"/>	Graphite black RAL 9011	24,95 €





D LINE LIVE END FEEDER LEFT

- plastic
- dimensions L x W x H: 98,50 x 35,20 x 35,50 mm
- suitable for mounting and built in system
- up to 3-phases can be fed in

710009	<input type="checkbox"/>	Traffic white RAL 9016	12,95 €
710010	<input type="checkbox"/>	Window grey RAL 7040	12,95 €
710011	<input type="checkbox"/>	Graphite black RAL 9011	12,95 €



accessories for built in system

710089	cover plate built in track feeder left/right	2,95 €
---------------	--	---------------



D LINE LIVE END FEEDER RIGHT

- plastic
- dimensions L x W x H: 98,50 x 35,20 x 35,50 mm
- suitable for mounting and built in system
- up to 3-phases can be fed in

710012	<input type="checkbox"/>	Traffic white RAL 9016	12,95 €
710013	<input type="checkbox"/>	Window grey RAL 7040	12,95 €
710014	<input type="checkbox"/>	Graphite black RAL 9011	12,95 €



accessories for built in system

710089	cover plate built in track feeder left/right	2,95 €
---------------	--	---------------





D LINE ELECTRICAL STRAIGHT CONNECTOR WITH CENTER FEED OPTION

- plastic
- dimensions L x W x H: 166 x 35 x 35,50 mm
- suitable for mounting and built in system
- up to 3-phases can be fed in

710042	<input type="checkbox"/>	Traffic white RAL 9016	28,95 €
710043	<input type="checkbox"/>	Window grey RAL 7040	28,95 €
710044	<input type="checkbox"/>	Graphite black RAL 9011	28,95 €



accessories for built in system

710090	cover plate built in track Längsverbinder	2,95 €
---------------	---	---------------



D LINE FLEXIBLE-CONNECTOR LEFT-RIGHT

- plastic
- dimensions L x W x H: 248 x 35 x 35,50 mm
- suitable for mounting system

710039	<input type="checkbox"/>	Traffic white RAL 9016	36,95 €
710040	<input type="checkbox"/>	Window grey RAL 7040	36,95 €
710041	<input type="checkbox"/>	Graphite black RAL 9011	36,95 €





D LINE ELECTRICAL JOINT

- plastic
- dimensions L x W x H: 68 x 20,50 x 26,50 mm
- suitable for mounting and built in system

710015	<input type="checkbox"/>	Traffic white RAL 9016	8,95 €
710016	<input checked="" type="checkbox"/>	Window grey RAL 7040	8,95 €
710017	<input checked="" type="checkbox"/>	Graphite black RAL 9011	8,95 €



D LINE MECHANICAL JOINT

- plastic
- dimensions L x W x H: 66,40 x 20 x 27 mm
- suitable for mounting and built in system

710018	<input type="checkbox"/>	Traffic white RAL 9016	5,95 €
710019	<input checked="" type="checkbox"/>	Window grey RAL 7040	5,95 €
710020	<input checked="" type="checkbox"/>	Graphite black RAL 9011	5,95 €



If, for example, more complex track installations are to be visually connected to one piece, but several different power supplies/controls are used, the mechanical connector is ideal. Visually, the track appears to be in one piece, electrically the two sections are separated from each other.



D LINE 90°-JOINT LEFT-RIGHT WITH EXCHANGE MECHANISM

- plastic
- dimensions L x W x H: 100,7 x 100,7 x 35,50 mm
- suitable for mounting and built in system

710036	<input type="checkbox"/>	Traffic white RAL 9016	29,95 €
710037	<input type="checkbox"/>	Window grey RAL 7040	29,95 €
710038	<input type="checkbox"/>	Graphite black RAL 9011	29,95 €



accessories for built in system

710091	cover plate built in track 90°-joint	2,95 €
---------------	--------------------------------------	---------------

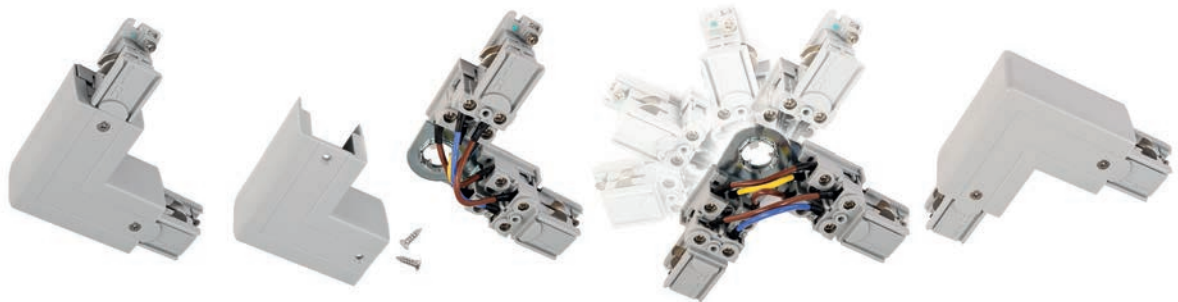

By simply removing the cover of the corner connector, the alignment [left/right] can be reversed. This eliminates the annoying rethinking [N conductor left or right] and makes both planning and installation child's play.

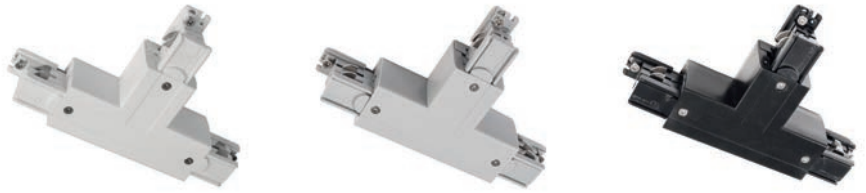

D LINE T-JOINT LEFT-LEFT-RIGHT WITH EXCHANGE MECHANISM

- plastic
- dimensions L x W x H: 166 x 101 x 35,50 mm
- suitable for mounting and built in system

710027	<input type="checkbox"/>	Traffic white RAL 9016	41,95 €
710028	<input type="checkbox"/>	Window grey RAL 7040	41,95 €
710029	<input type="checkbox"/>	Graphite black RAL 9011	41,95 €



D LINE T-JOINT RIGHT-RIGHT-LEFT WITH EXCHANGE MECHANISM

- plastic
- dimensions L x W x H: 166 x 101 x 35,50 mm
- suitable for mounting and built in system

710030	<input type="checkbox"/>	Traffic white RAL 9016	41,95 €
710031	<input type="checkbox"/>	Window grey RAL 7040	41,95 €
710032	<input type="checkbox"/>	Graphite black RAL 9011	41,95 €



accessories for built in system

710093	cover plate built in track T-joint	2,95 €
---------------	------------------------------------	---------------

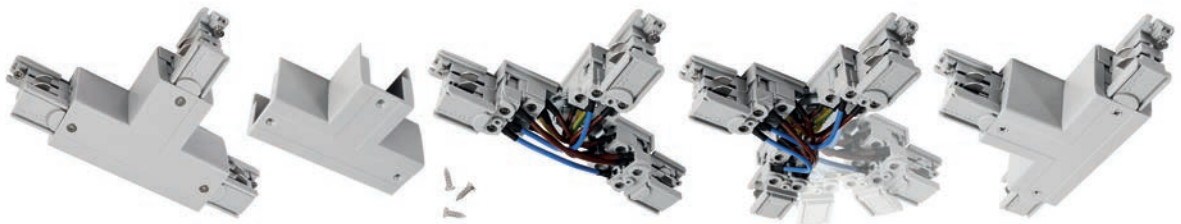

Almost identically to the corner connector, the direction [left/right] of the T-connector can also be changed by removing the cover. Due to the design, however, there are two T-connectors in each colour variant, as it may be that either left/left/right or right/right/left is required depending on the

alignment. But also with this article, the variants could be reduced by half. This also means here: significantly simplified planning and assembly.

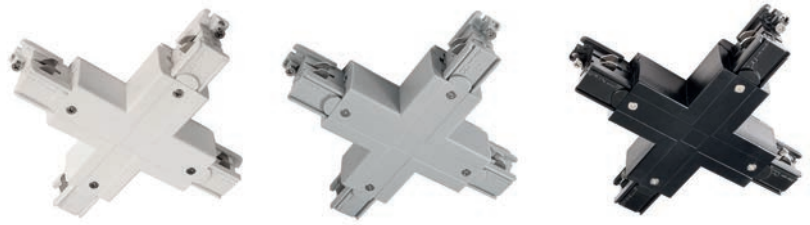

D LINE X-JOINT LEFT-LEFT-RIGHT-RIGHT

- plastic
- dimensions L x W x H: 166 x 166 x 35,50 mm
- suitable for mounting and built in system

710033	<input type="checkbox"/>	Traffic white RAL 9016	56,95 €
710034	<input type="checkbox"/>	Window grey RAL 7040	56,95 €
710035	<input type="checkbox"/>	Graphite black RAL 9011	56,95 €



accessories for built in system

710092	cover plate built in track X-joint	3,95 €
---------------	------------------------------------	---------------



With the kind support of WIBU-SYSTEMS AG Karlsruhe



D LINE COVER PLATE BUILT IN TRACK

- plastic
- dimensions L x W x H: 1000 x 21,50 x 7,50 mm
- suitable for mounting and built in system

710077	<input type="checkbox"/>	Traffic white RAL 9016	4,95 €
710079	<input checked="" type="checkbox"/>	Graphite black RAL 9011	4,95 €

Conductor rails mounted within a possible contact zone or at a height of less than 2.30 m must additionally be closed with a cover panel.



D LINE ENDCAP

- plastic
- dimensions L x W x H: 31,30 x 35,20 x 32,50 mm
- suitable for mounting and built in system

710066	<input type="checkbox"/>	Traffic white RAL 9016	1,95 €
710067	<input checked="" type="checkbox"/>	Window grey RAL 7040	1,95 €
710068	<input checked="" type="checkbox"/>	Graphite black RAL 9011	1,95 €



D LINE MOUNTING BRACKET FLEX

- metal
- dimensions L x W x H: 40 x 33,80 x 12,50 mm
- suitable for mounting system

710063	<input type="checkbox"/>	Traffic white RAL 9016	4,95 €
710064	<input checked="" type="checkbox"/>	Window grey RAL 7040	4,95 €
710065	<input type="checkbox"/>	Graphite black RAL 9011	4,95 €



D LINE SUSPENSION CLAMP FOR TRACK CONNECTION

- metal
- dimensions L x W x H: 181 x 32 x 20 mm
- suitable for mounting system
- for chain assembly
[chain not included]

710057	<input type="checkbox"/>	Traffic white RAL 9016	8,95 €
710058	<input checked="" type="checkbox"/>	Window grey RAL 7040	8,95 €
710059	<input type="checkbox"/>	Graphite black RAL 9011	8,95 €



D LINE CEILING SUSPENSION RIGID

- metal
- dimensions L x W: 635 x 60 mm
- stable and shapely suspension
- suspension dimension 635 mm [can be shortened to 335 mm]
- suspension dimension can be extended by means of accessories
- suitable for mounting system

710078	<input type="checkbox"/>	Traffic white RAL 9016	29,95 €
710085	<input checked="" type="checkbox"/>	Window grey RAL 7040	29,95 €
710084	<input checked="" type="checkbox"/>	Graphite black RAL 9011	29,95 €



EXTENSION FOR CEILING SUSPENSION

- metal
- dimensions L x W: 300 x 10 mm
- increases the suspension dimension by 300 mm each
- suitable for rigid ceiling suspension

710086	<input type="checkbox"/>	Traffic white RAL 9016	4,95 €
710088	<input checked="" type="checkbox"/>	Window grey RAL 7040	4,95 €
710087	<input checked="" type="checkbox"/>	Graphite black RAL 9011	4,95 €



D LINE WIRE SUSPENSION BRACKET

- metal / plastic
- dimensions L x W x H: 120 x 31 x 52 mm
- rope length: 1500 mm
- suspension dimension can be individually shortened: 120-1500 mm
- suitable for mounting system

710048	<input type="checkbox"/>	Traffic white RAL 9016	10,95 €
710049	<input type="checkbox"/>	Window grey RAL 7040	10,95 €
710050	<input type="checkbox"/>	Graphite black RAL 9011	10,95 €

accessories

710081	rope L: 4000 mm	5,95 €
---------------	-------------------	---------------



D LINE ROPE SUSPENSION BRACKET MINI

- metal
- dimensions L x W x H: 120 x 31 x 58 mm
- beautifully shaped and filigree suspension
- rope length: 5000 mm
- suspension dimension can be individually shortened: 90 - 4980 mm
- suitable for mounting system

710094	<input type="checkbox"/>	Traffic white RAL 9016	17,95 €
710095	<input type="checkbox"/>	Window grey RAL 7040	17,95 €
710096	<input type="checkbox"/>	Graphite black RAL 9011	17,95 €





D LINE QUICK MOUNTING CLAMP FOR TRADE FAIR CONSTRUCTION

- aluminium
- dimensions L x W x H: 40 x 30 x 11,90 mm
- suitable for mounting system

710082 ■ Graphite black RAL 9011

9,95 €

Especially in trade fair construction, where busbars are frequently mounted and dismantled, the quick mounting clamp is the perfect mounting aid. The conductor rail is clicked into place with the spring clip and fixed in place without tools by means of a knurled screw. Conductor rail installation has never been faster.

D LINE TRUSS ADAPTER

- aluminium
- dimensions L x W x H: 40 x 30 x 11,90 mm
- suitable for mounting system

710083 □ silver coloured

24,95 €

Thanks to the quick-release fasteners of the truss adapter, the D LINE busbars can be mounted in seconds on the trusses with 50 mm tube diameters commonly used in event technology and exhibition stand construction.





This little "jack-of-all-trades" makes mounting a track on an existing grid ceiling child's play. The installation time is only a fraction of what it used to be. In the first step, the clip is simply clicked into the visible metal strips of the grid ceiling and is held bomb-proof on the ceiling by means of a safety spring clip. After that, the conductor rail is simply pushed onto it and the installation is finished.





D LINE QUICK MOUNTING BRACKET FOR GRID CEILINGS

- metal
- dimensions L x W x H: 120 x 31 x 11 mm
- suitable for mounting system

710051 Traffic white RAL 9016

8,95 €

710052 Window grey RAL 7040

8,95 €

710053 Graphite black RAL 9011

8,95 €





D LINE 3-PHASE-ADAPTER FOR LUMINAIRE MOUNTING

- plastic / metal
- dimensions L x W x H: 58,50 x 32 x 42 mm
- max. 10 kg/100N
- suitable for mounting and built in system
- delivery includes trumpet nipple and M10 flat nut
- luminaire not included

710021	<input type="checkbox"/>	Traffic white RAL 9016	12,95 €
710022	<input checked="" type="checkbox"/>	Window grey RAL 7040	12,95 €
710023	<input type="checkbox"/>	Graphite black RAL 9011	12,95 €



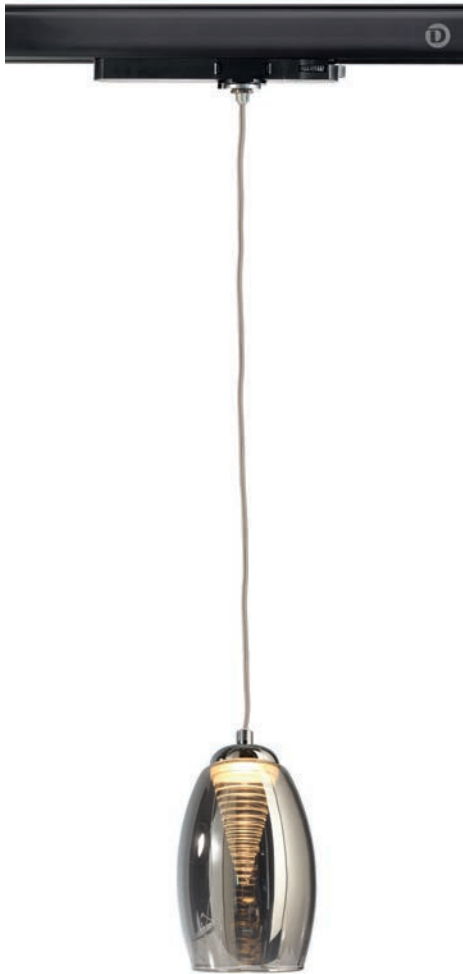

D LINE 3-PHASE-ADAPTER WITH MULTI CC POWER SUPPLY

- plastic / metal
- dimensions L x W x H: 162 x 31 x 41mm
- max. 10 kg/100N
- suitable for mounting and built in system
- delivery includes trumpet nipple and M10 flat nut
- luminaire not included
- integrated, adjustable, current-stable power supply [CC]
- exclusively for 3-phase power rail from D LINE, Ivela and Hoffmeister
- it is essential to check suitability of the intended luminaire



862180	<input type="checkbox"/>	Traffic white RAL 9016	250/350/450/500 mA	6,30 - 21,00 W	25-42V	29,95 €
862181	<input type="checkbox"/>	Traffic white RAL 9016	600/700/750/800 mA	15,00 - 33,60 W	25-42V	32,95 €
862182	<input type="checkbox"/>	Traffic white RAL 9016	850/900/950/1050 mA	23,00 - 44,10 W	27-42V	35,95 €
862183	<input checked="" type="checkbox"/>	Graphite black RAL 9011	250/350/450/500 mA	6,30 - 21,00 W	25-42V	29,95 €
862184	<input checked="" type="checkbox"/>	Graphite black RAL 9011	600/700/750/800 mA	15,00 - 33,60 W	25-42V	32,95 €
862185	<input checked="" type="checkbox"/>	Graphite black RAL 9011	850/900/950/1050 mA	23,00 - 44,10 W	27-42V	35,95 €





D LINE ELECTRICAL OUTLET ADAPTER

- plastic
- dimensions L x W x H: 58,50 x 53,50 x 103 mm
- integrated fuse
- suitable for mounting and built in system

710024	<input type="checkbox"/>	Traffic white RAL 9016	24,95 €
710026	<input checked="" type="checkbox"/>	Graphite black RAL 9011	24,95 €

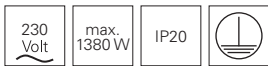

D LINE MOUNTING ADAPTER FOR ADDITIONAL COMPONENTS MAX. 10KG

- metal
- dimensions L x W x H: 66,50 x 31,50 x 84 mm
- max. 10 kg/100N
- suitable for mounting and built in system

710054	<input type="checkbox"/>	Traffic white RAL 9016	8,95 €
710055	<input checked="" type="checkbox"/>	Window grey RAL 7040	8,95 €
710056	<input type="checkbox"/>	Graphite black RAL 9011	8,95 €



With our socket adapter, additional devices, lights etc. can be supplied with power in the simplest way. In combination with the »Mounting adapter for additional components« [710054/55/56], additional headlights or other devices [up to 10kg] can be attached and supplied with power.



D LINE SIGNS HOOK

- plastic
- dimensions H x Ø: 52 x 25 mm
- suitable for mounting and built in system

710060	<input type="checkbox"/>	Traffic white RAL 9016	1,95 €
710061	<input type="checkbox"/>	Window grey RAL 7040	1,95 €
710062	<input type="checkbox"/>	Graphite black RAL 9011	1,95 €



page 647



page 648



page 649



page 650



page 651



page 652



page 653



page 654



page 655



page 656



page 657



page 658



page 659



page 660



page 661



page 662



page 663



page 664



page 665



page 666



page 666



page 667



page 667



□
page 668

power rail spotlights

COMPATIBILITY OVERVIEW

power rail D LINE	luminaires and power rail adapters from:						
	D LINE	Global	Ivela	Erco	Hoffmeister	Zumtobel/ Staff	Eutrac
	compatible	compatible	compatible	compatible	compatible	compatible	compatible

luminaires DEKO-LIGHT	3-phase power rail from:						
	D LINE	Global	Ivela	Erco	Hoffmeister	Zumtobel/ Staff	Eutrac
	compatible	compatible*	compatible*	compatible*	compatible*	compatible*	compatible*

*compatible with all DEKO-LIGHT 3-phase spotlights, except AIN series [p. 649] and 3-phase adapter with integrated multi-CC power supply unit [p. 641].

All data without guarantee. Technical data and dimensions are subject to change without prior notice. Check against samples when planning a project to ensure functionality.



PANEL TRACK LIGHT

- aluminium
- dimensions L x W x H: 300 x 100 x 22 mm

707059	<input type="checkbox"/>	Traffic white RAL 9016 mat	<input type="checkbox"/>	3000 K	1470 lm	139,95 €
707017	<input type="checkbox"/>	Traffic white RAL 9016 mat	<input type="checkbox"/>	4000 K	1500 lm	139,95 €
707060	<input checked="" type="checkbox"/>	black mat	<input type="checkbox"/>	3000 K	1470 lm	139,95 €
707058	<input checked="" type="checkbox"/>	black mat	<input type="checkbox"/>	4000 K	1500 lm	139,95 €

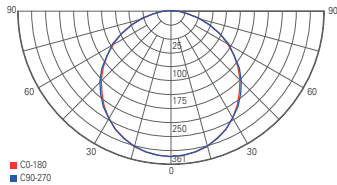

light distribution curve





DRACONIS

- light colour and output adjustable via CCT dip switch
- high luminous intensity [bis 8200 lm]
- aluminium diecast
- dimensions L x W x H: 578 x 189 x 129 mm
- socket L x W x H: 102 x 88 x 25 mm

620120	<input type="checkbox"/>	Traffic white RAL 9016	WW	NW	2700 / 3500 / 4000 K	8215 lm	339,95 €
620119	<input type="checkbox"/>	White aluminium RAL 9006	WW	NW	2700 / 3500 / 4000 K	8215 lm	339,95 €

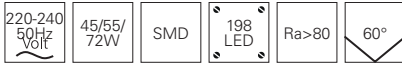

suitable
pendant lights
page 547
620122
620121



suitable
ceiling lights
page 529
348128
348099



accessories

930577	15° lens asymmetric	7,95 €
930544	20° lens symmetric	7,95 €
930545	30° lens symmetric	7,95 €
930546	90° lens symmetric	7,95 €

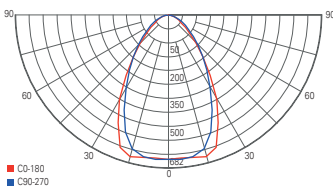

light distribution curve 620119 - 45 W

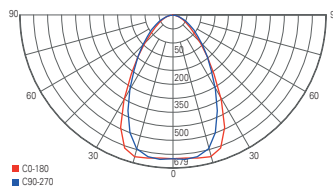

light distribution curve 620119 - 55 W

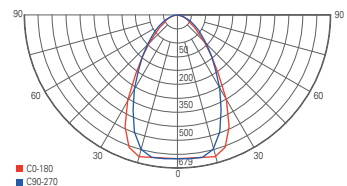

light distribution curve 620119 - 72 W



AIN 24-30W

- aluminium
- dimensions L x W x H: 336 x 36 x 49 mm
- socket L x W x H: 195 x 30 x 50 mm
- UGR <16
- exclusively for 3-phase power rails from D LINE, Ivela and Hoffmeister

707072	<input type="checkbox"/>	white	<input type="checkbox"/>	3000 K	2400 lm	169,95 €
707075	<input type="checkbox"/>	white	<input type="checkbox"/>	4000 K	2400 lm	169,95 €
707073	<input type="checkbox"/>	silver coloured	<input type="checkbox"/>	3000 K	2400 lm	169,95 €
707076	<input type="checkbox"/>	silver coloured	<input type="checkbox"/>	4000 K	2400 lm	169,95 €
707071	<input type="checkbox"/>	black	<input type="checkbox"/>	3000 K	2400 lm	169,95 €
707074	<input type="checkbox"/>	black	<input type="checkbox"/>	4000 K	2400 lm	169,95 €



accessories

930386	reflector 12° silver coloured	1,95 €
930387	reflector 48° silver coloured	1,95 €
930388	Anti Glare white	2,95 €

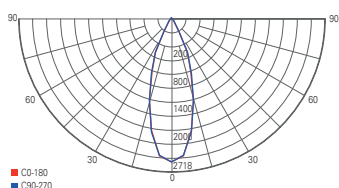

light distribution curve 620119 - 45 W



LINEAR 60

- aluminium
- dimensions L x W x H: 687 x 33 x 52 mm

707046	<input type="checkbox"/>	Traffic white RAL 9016	<input type="checkbox"/>	3000 K	1655 lm	119,95 €
707015	<input type="checkbox"/>	Traffic white RAL 9016	<input type="checkbox"/>	4000 K	1655 lm	119,95 €
707048	<input type="checkbox"/>	silver coloured mat	<input type="checkbox"/>	3000 K	1655 lm	119,95 €
707045	<input type="checkbox"/>	silver coloured mat	<input type="checkbox"/>	4000 K	1655 lm	119,95 €
707047	<input type="checkbox"/>	black mat	<input type="checkbox"/>	3000 K	1655 lm	119,95 €
707034	<input type="checkbox"/>	black mat	<input type="checkbox"/>	4000 K	1655 lm	119,95 €

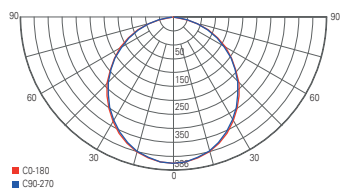
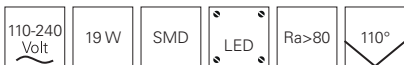

light distribution curve



LINEAR 100

- aluminium
- dimensions L x W x H: 1087 x 33 x 52 mm

707087	<input type="checkbox"/>	Traffic white RAL 9016 mat	<input type="checkbox"/>	3000 K	2900 lm	159,95 €
707084	<input type="checkbox"/>	Traffic white RAL 9016 mat	<input type="checkbox"/>	4000 K	2900 lm	159,95 €
707053	<input type="checkbox"/>	silver coloured mat	<input type="checkbox"/>	3000 K	2435 lm	159,95 €
707050	<input type="checkbox"/>	silver coloured mat	<input type="checkbox"/>	4000 K	2435 lm	159,95 €
707088	<input checked="" type="checkbox"/>	black mat	<input type="checkbox"/>	3000 K	2900 lm	159,95 €
707085	<input checked="" type="checkbox"/>	black mat	<input type="checkbox"/>	4000 K	2900 lm	159,95 €

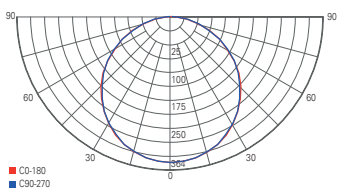
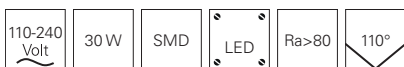

■ C0-180
■ C90-270

light distribution curve



CAN

- aluminium diecast
- dimensions L x Ø: 134 x 60 mm

707079	<input type="checkbox"/> white	42,95 €
707080	<input type="checkbox"/> silver coloured	42,95 €
707081	<input type="checkbox"/> black	42,95 €



accessories

930301	reflector ring H: 28 mm white	3,95 €
930302	reflector ring H: 28 mm black	3,95 €
930303	reflector ring H: 28 mm gold optics mat	3,95 €
930366	reflector ring H: 28 mm silver coloured mat	3,95 €
180080	MAS LED spot 2700 K 3,7 W 260 lm 36° EEI: A+	9,95 €
180081	PARATTHOM 2700 K 4,3 W 350 lm 36° EEI: A	4,95 €
180109	MASTER VALUE 2700 K 3,7 W 260 lm 36° EEI: A+	14,95 €
180113	MASTER VALUE 2700 K 4,9 W 355 lm 36° EEI: A+	15,95 €
180049	MASTER VALUE 2700 K 4,9 W 355 lm 60° EEI: A+	12,95 €
180050	MASTER VALUE 3000 K 4,9 W 365 lm 60° EEI: A+	12,95 €
180051	MASTER VALUE 4000 K 4,9 W 380 lm 60° EEI: A+	12,95 €
180052	MASTER VALUE 2700 K 4,9 W 355 lm 36° EEI: A+	12,95 €
180099	MASTER VALUE 3000 K 4,9 W 365 lm 36° EEI: A+	12,95 €
180053	MASTER VALUE 4000 K 4,9 W 380 lm 36° EEI: A+	12,95 €



AARON

- aluminium
- dimensions L x W x Ø: 255 x 182 x 120 mm

707092	<input type="checkbox"/>	white mat	<input type="checkbox"/>	3000K	7400 lm	469,95 €
707093	<input type="checkbox"/>	white mat	<input type="checkbox"/>	4000K	7400 lm	469,95 €
707090	<input checked="" type="checkbox"/>	black mat	<input type="checkbox"/>	3000K	7400 lm	469,95 €
707091	<input checked="" type="checkbox"/>	black mat	<input type="checkbox"/>	4000K	7400 lm	469,95 €

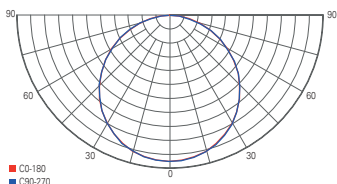

light distribution curve



HORUS

- plastic
- dimensions L x Ø: 125 x 60 mm
- UGR <19

707095	<input type="checkbox"/> white mat	<input type="checkbox"/> ww 3000 K	625 lm	69,95 €
707097	<input type="checkbox"/> white mat	<input type="checkbox"/> nw 4000 K	635 lm	69,95 €
707094	<input checked="" type="checkbox"/> black mat	<input type="checkbox"/> ww 3000 K	625 lm	69,95 €
707096	<input checked="" type="checkbox"/> black mat	<input type="checkbox"/> nw 4000 K	635 lm	69,95 €

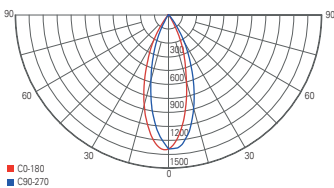

light distribution curve 707094 | 707095

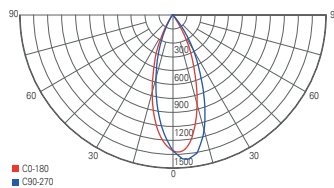

light distribution curve 707096 | 707094



HORUS

- plastic
- dimensions L x Ø: 140 x 70 mm
- UGR <19

707099	<input type="checkbox"/>	white mat	<input type="checkbox"/>	3000 K	915 lm	78,95 €
707101	<input type="checkbox"/>	white mat	<input type="checkbox"/>	4000 K	1030 lm	78,95 €
707098	<input checked="" type="checkbox"/>	black mat	<input type="checkbox"/>	3000 K	915 lm	78,95 €
707100	<input checked="" type="checkbox"/>	black mat	<input type="checkbox"/>	4000 K	1030 lm	78,95 €

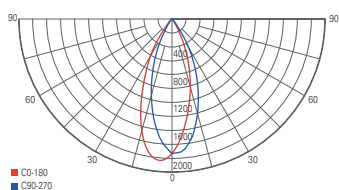

light distribution curve 707098 | 707099

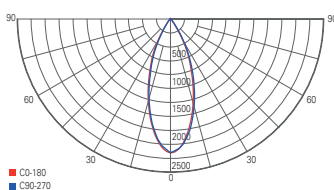

light distribution curve 707100 | 707101



HORUS

- plastic
- dimensions L x Ø: 185 x 80 mm
- UGR < 19

707103	<input type="checkbox"/>	white mat	<input type="checkbox"/>	3000 K	1705 lm	88,95 €
707105	<input type="checkbox"/>	white mat	<input type="checkbox"/>	4000 K	1785 lm	88,95 €
707102	<input checked="" type="checkbox"/>	black mat	<input type="checkbox"/>	3000 K	1705 lm	88,95 €
707104	<input checked="" type="checkbox"/>	black mat	<input type="checkbox"/>	4000 K	1785 lm	88,95 €

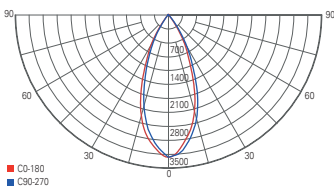

light distribution curve 707102 | 707103

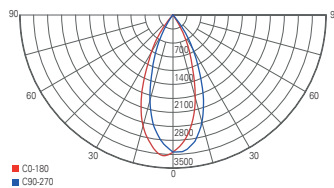

light distribution curve 707104 | 707105



HORUS

- plastic
- dimensions L x Ø: 210 x 90 mm
- UGR <19

707107	<input type="checkbox"/>	white mat	<input type="checkbox"/>	3000 K	2525 lm	106,95 €
707109	<input type="checkbox"/>	white mat	<input type="checkbox"/>	4000 K	2605 lm	106,95 €
707106	<input checked="" type="checkbox"/>	black mat	<input type="checkbox"/>	3000 K	2525 lm	106,95 €
707108	<input checked="" type="checkbox"/>	black mat	<input type="checkbox"/>	4000 K	2605 lm	106,95 €

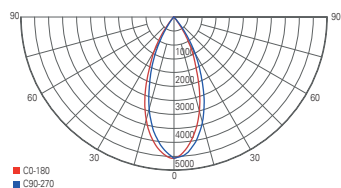

light distribution curve 707106 | 707107

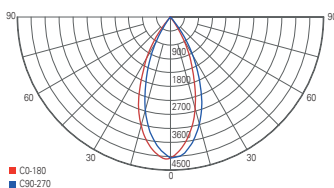

light distribution curve 707108 | 707109



LUNA 15

- aluminium diecast
- dimensions L x H x Ø: 159 x 101 x 63 mm
- dimmable via leading or trailing edge

707022	<input type="checkbox"/>	Pure white RAL 9010	ww	3000 K	1140 lm	149,95 €
707023	<input type="checkbox"/>	Pure white RAL 9010	nw	4000 K	1100 lm	149,95 €
707024	<input checked="" type="checkbox"/>	Signal black RAL 9004	ww	3000 K	1140 lm	149,95 €
707025	<input checked="" type="checkbox"/>	Signal black RAL 9004	nw	4000 K	1100 lm	149,95 €



suitable
ceiling lights
page 519
348040
348041
348057
348058

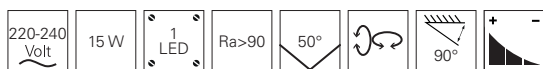

accessories

930188	reflector 20°	9,95 €
930189	reflector 30°	9,95 €

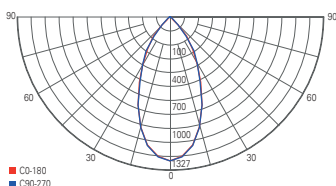

light distribution curve



LUNA 30

- aluminium diecast
- dimensions L x H x Ø: 165 x 121 x 85 mm
- dimmable via leading or trailing edge

707018	<input type="checkbox"/>	Pure white RAL 9010	WW	3000 K	1930 lm	179,95 €
707019	<input type="checkbox"/>	Pure white RAL 9010	NW	4000 K	2210 lm	179,95 €
707026	<input checked="" type="checkbox"/>	Signal black RAL 9004	WW	3000 K	1930 lm	179,95 €
707027	<input checked="" type="checkbox"/>	Signal black RAL 9004	NW	4000 K	2210 lm	179,95 €



suitable
ceiling lights
page 520
348059
348060
348062

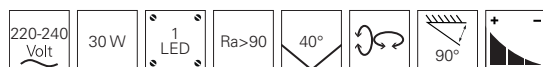

accessories

930196	reflector 20°	12,95 €
930239	reflector 30°	12,95 €
930210	barn door white	25,95 €
930211	barn door black	25,95 €

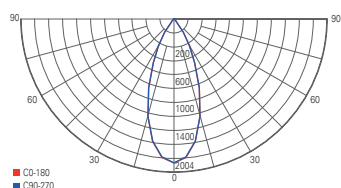

light distribution curve



LUNA 40

- aluminium diecast
- dimensions L x H x Ø: 201 x 168 x 120 mm
- dimmable via leading or trailing edge

707020	<input type="checkbox"/>	Pure white RAL 9010	ww	3000 K	2520 lm	215,95 €
707021	<input type="checkbox"/>	Pure white RAL 9010	nw	4000 K	2820 lm	215,95 €
707028	<input checked="" type="checkbox"/>	Signal black RAL 9004	ww	3000 K	2520 lm	215,95 €
707029	<input checked="" type="checkbox"/>	Signal black RAL 9004	nw	4000 K	2820 lm	215,95 €



suitable
ceiling lights
page 521
348063
348065
348066

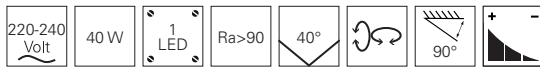

accessories

930206	reflector 20°	15,95 €
930207	reflector 30°	15,95 €

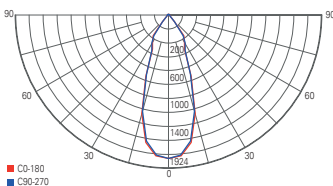

light distribution curve



LUNA 30 CCT FLEX

- aluminium
- dimensions L x H x Ø: 162,5 x 161 x 85 mm
- infinitely dimmable
- light colour adjustable
- CCT Dip

707061	<input type="checkbox"/>	white mat	<input type="checkbox"/>	cw	2600-6250 K	2100 lm	349,95 €
707062	<input checked="" type="checkbox"/>	black mat	<input type="checkbox"/>	cw	2600-6250 K	2100 lm	349,95 €



suitable
ceiling lights
page 520
348059
348060
348061
348062

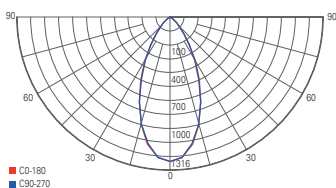
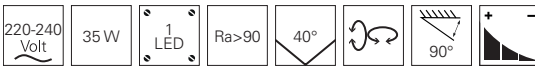

light distribution curve



NIHAL MINI

- aluminium diecast
- dimensions L x W x H x Ø: 94 x 102 x 139 x 60 mm
- dimmable via leading or trailing edge

707036	<input type="checkbox"/>	white	<input type="checkbox"/>	3000 K	950 lm	144,95 €
707038	<input type="checkbox"/>	white	<input type="checkbox"/>	4000 K	1180 lm	144,95 €
707054	<input type="checkbox"/>	silver coloured	<input type="checkbox"/>	3000 K	950 lm	144,95 €
707055	<input type="checkbox"/>	silver coloured	<input type="checkbox"/>	4000 K	1180 lm	144,95 €
707037	<input type="checkbox"/>	black	<input type="checkbox"/>	3000 K	950 lm	144,95 €
707039	<input type="checkbox"/>	black	<input type="checkbox"/>	4000 K	1180 lm	144,95 €

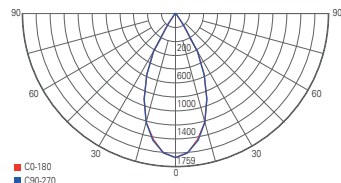
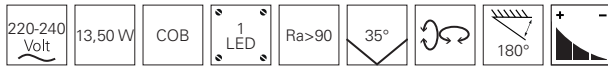

light distribution curve



accessories

930301	reflector ring white	3,95 €
930302	reflector ring black	3,95 €
930303	reflector ring gold	3,95 €
930366	reflector ring silver	3,95 €
930297	side cover white	2,95 €
930298	side cover black	2,95 €
930299	side cover gold	2,95 €
930300	side cover wooden look	4,95 €
930364	side cover silver	2,95 €
930306	reflector 50°	9,95 €
930307	honeycomb filter	9,95 €
930308	spread lens 40° clear/satined	9,95 €
930309	softening lens 47° satined	9,95 €
930310	linear spread lens 40°/80° asymmetrisch clear/satined	9,95 €



NIHAL

- aluminium diecast
- dimensions L x W x H x Ø: 135 x 138 x 188 x 86 mm
- dimmable via leading or trailing edge

707040	<input type="checkbox"/>	white	<input type="checkbox"/>	ww	3000 K	2450 lm	185,95 €
707042	<input type="checkbox"/>	white	<input type="checkbox"/>	nw	4000 K	2860 lm	185,95 €
707056	<input type="checkbox"/>	silver coloured	<input type="checkbox"/>	ww	3000 K	2470 lm	185,95 €
707057	<input type="checkbox"/>	silver coloured	<input type="checkbox"/>	nw	4000 K	2860 lm	185,95 €
707041	<input type="checkbox"/>	black	<input type="checkbox"/>	ww	3000 K	2450 lm	185,95 €
707043	<input type="checkbox"/>	black	<input type="checkbox"/>	nw	4000 K	2860 lm	185,95 €

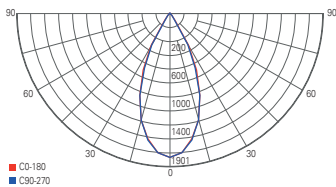
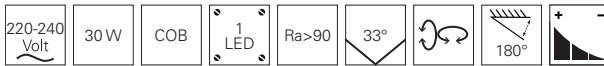

light distribution curve



accessories

930315	reflector ring white	3,95 €
930316	reflector ring black	3,95 €
930317	reflector ring gold	3,95 €
930365	reflector ring silver	3,95 €
930311	side cover white	4,95 €
930312	side cover black	4,95 €
930313	side cover gold	4,95 €
930314	side cover wooden look	6,95 €
930363	side cover silver	4,95 €
930318	reflector 15°	15,95 €
930320	reflector 50°	15,95 €
930321	honeycomb filter	9,95 €
930322	spread lens 40° clear/satined	9,95 €
930323	softening lens 47° satined	9,95 €
930324	linear spread lens 40°/80° asymmetrisch clear/satined	9,95 €



PLEIONE FOCUS I

- aluminium diecast
- dimensions L x H x Ø: 181 x 180 x 68 mm
- focusable lens
- light cone infinitely adjustable [25°-60°]

707069	<input type="checkbox"/>	Signal white RAL 9003	<input checked="" type="checkbox"/>	3000 K	1100 lm	192,95 €
707070	<input type="checkbox"/>	Signal white RAL 9003	<input checked="" type="checkbox"/>	4000 K	1150 lm	192,95 €

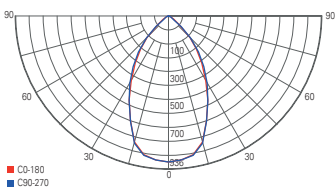

light distribution curve 707069

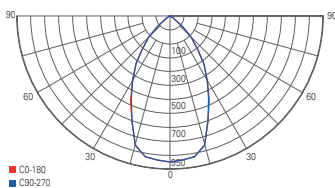

light distribution curve 707070



PLEIONE FOCUS II

- aluminium diecast
- dimensions L x H x Ø: 195 x 160 x 90 mm
- focusable lens
- light cone infinitely adjustable [25°-60°]

707067	<input type="checkbox"/>	Signal white RAL 9003	<input checked="" type="checkbox"/>	3000 K	3050 lm	265,95 €
707068	<input type="checkbox"/>	Signal white RAL 9003	<input checked="" type="checkbox"/>	4000 K	3300 lm	265,95 €

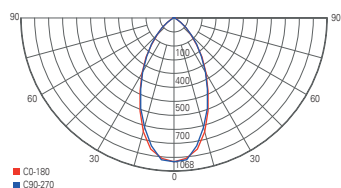

light distribution curve 707067

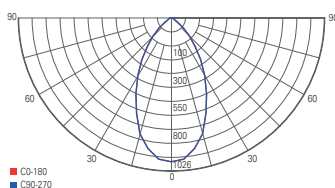

light distribution curve 707068



FLOOD SMD

- aluminium diecast
- dimensions L x W x H: 170 x 143,5 x 27 mm
- socket L x W: 179 x 20 mm

707030	<input type="checkbox"/>	Traffic white RAL 9016	<input type="checkbox"/>	3000 K	1325 lm	74,95 €
707031	<input type="checkbox"/>	Traffic white RAL 9016	<input type="checkbox"/>	4000 K	1349 lm	74,95 €

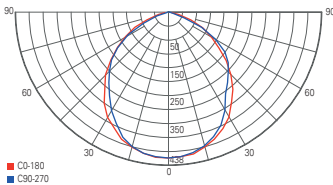

light distribution curve 707030

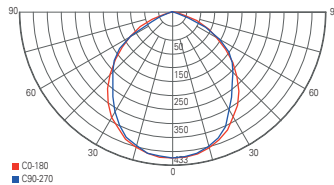

light distribution curve 707031



FLOOD SMD I

- aluminium diecast
- dimensions L x W x H: 230 x 192,5 x 40,5 mm
- socket L x W: 237 x 25 mm

707032	<input type="checkbox"/>	Traffic white RAL 9016	<input type="checkbox"/>	3000 K	2600 lm	129,95 €
707033	<input type="checkbox"/>	Traffic white RAL 9016	<input type="checkbox"/>	4000 K	2650 lm	129,95 €

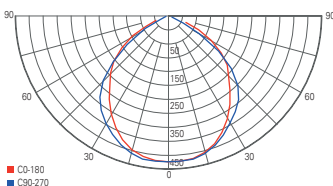

light distribution curve 707032

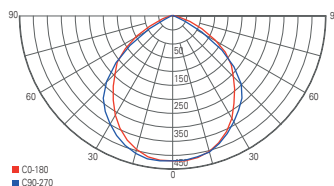

light distribution curve 707033

STUDIO PAR 30

- aluminium
- dimensions L x H: 270,75 x 158,77 mm
- incl. adapter

707082 ■ black

63,95 €



accessories

001621 barn door | black

24,95 €

suitable illuminants on page 973-975



STUDIO PAR 30

- aluminium
- dimensions L x H: 271 x 159 mm

707083 □ silver coloured

63,95 €



suitable illuminants on page 973-975





suitable
ceiling lights
ab page 522
348124
348125
348107



suitable
wall light
page 523
341215

UNI II

- aluminium diecast
- dimensions L x Ø: 167 x 100 mm
- dimmable via leading or trailing edge

707044 Signal white RAL 9003  3000 K 910 lm **159,95 €**

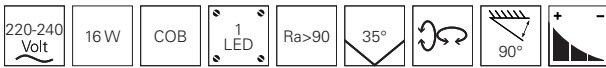

accessories

930339	reflector ring black	9,95 €
930340	reflector ring gold	9,95 €
930341	reflector ring chrom	9,95 €
930371	reflector ring II black glossy	9,95 €
930335	cover backside black	2,95 €
930337	cover heatsink black	2,95 €
930306	reflector 50°	9,95 €
930307	honeycomb filter	9,95 €
930308	spread lens 40° clear/satined	9,95 €
930309	softening lens 47° satined	9,95 €
930310	linear spread lens 40°/80° asymmetric clear/satined	9,95 €





ALUMINIUM PROFILES

- 672 linear light in 5 steps
- 674 lighting solution
- 684 assembly | configurator
- 686 homogeneous light image
- 680 aluminium profiles | overview
- 688 aluminium profiles | quick finder
- 694 covers | overview
- 697 RAL coating
- 700 U-profiles | flat + high | built-in/mounting
- 712 T-profiles | flat + high | built-in
- 724 H-/slot-profiles
- 734 step-/socket-/angle-/corner-profiles | built-in/mounting
- 762 dry construction profiles
- 776 tile profiles
- 792 profiles for outdoor | walkable/passable
- 802 assembly notes | assembly instructions
- 805 complete sets | IP67 | passable

LED STRIPES

- 808 technical information
- 818 information soft grouting and hard grouting
- 820 quick finder
- 824 COB | 1CH | 24V
- 828 COB | 2CH | 24V
- 830 COB | 3CH | 24V
- 832 Standard | 1CH | 12V
- 836 Standard | 1CH | 24V
- 842 Standard | 1CH | 48V
- 846 Standard | 2CH | 12V
- 848 Standard | 2CH | 24V
- 852 Standard | 3CH | 24V
- 856 Standard | 4CH | 24V
- 860 Standard | 3+2CH | 24V
- 862 D LENSE LINE | 1CH | 24V
- 864 D LENSE LINE | 3CH | 24V
- 866 D FLEX LINE Top-View | 1CH | 24V
- 870 D FLEX LINE Top-View | 3CH | 24V
- 872 D FLEX LINE Top-View | 4CH | 24V
- 874 D FLEX LINE Side-View | 1CH | 24V
- 878 D FLEX LINE Side-View | 3CH | 24V
- 880 D FLEX LINE Side-View | 4CH | 24V
- 882 230V | 1CH
- 884 assembly notes | assembly instructions
230V LED-Stripe

LINEAR LIGHT IN 5 STEPS

STEP BY STEP TO BECOMING A LINEAR LIGHT PROFESSIONAL!

It has never been quicker and easier to put together an individually and perfectly coordinated linear light in max. 5 steps. Test how quickly and easily you can put your personal project into practice.

1

CHOOSE YOUR PROFILE

Whether for indoor or outdoor use, for wide or narrow LED stripes, whether the profile is to be should be low or high. Matching to this you can choose between different shapes and light transmittance of the covers.

2

CHOOSE THE RIGHT LED STRIPE

You can choose between strips for indoor or outdoor use, with one or more light colours, high-power strips for basic lighting or fewer lumens for ambient lighting. Various cut sizes and LED spacing also perfectly round off our range here.



3

SELECT THE REQUIRED POWER SUPPLY

In addition to the various protection classes for the respective place of use and voltages, you can choose from different designs and power classes. Our range is complemented by power supplies that can be dimmed directly or controlled via Dali, KNX or 1-10V. Please also refer to our »Small 1x1 of power supply and control of LED stripes« from page 808.

4

DO YOU NEED A CONTROLLER TO STEER?

In this category, you can select the appropriate control controller or LED dimmer according to requirements and customer wishes. Whether control via radio, smartphone, DMX, Dali, etc. – almost no [control] wishes remain unfulfilled!



5

ACCESSORIES, MOUNTING MATERIAL & CO

In the last step, you will find everything that makes installation easier, faster and more comfortable and gives the linear desired light a perfect finish.

LINEAR LIGHT – FROM PLANNING TO THE FINISHED PROJECT

The right solution for every application – private and commercial

Light has several functions in the home. First and foremost, it serves to illuminate small and large small and large surfaces - from the dining table to the kitchen countertop in the kitchen to a cosy reading corner. On a less functional level, however, light primarily creates ambience, mood and the much quoted »feel-good factor«. This is where LED technology shows its strengths to the full and enables colour and intensity changes at the touch of a button – manually switched or programmed in the Smart Home.

Particularly in vogue – both with private individuals and with lighting designers and architects – is the so-called linear light. Linear light is indirect light in the form of LED stripes that are protected in precisely fitting aluminium profiles. These can be installed in a variety of ways on walls, ceilings, stairs or on furniture. There are hardly any limits to your own creativity. Use linear light to accentuate architectural elements and arouse emotions through the versatile interplay of light and shadow.





With the kind support of Friese Elektrotechnik, Eitenheim



With the kind support of BEST Belle and Elektro Service Team GmbH, Rauenberg-Malschenberg

MORE THAN JUST ACCENTS

However, linear light has much more to offer and is increasingly playing a central role in main lighting. Lighting designers are increasingly foregoing the use of classic luminaires and recessed spotlights in favour of a linear lighting solution. In combination with special LED stripes provide homogeneous light lines for effective lighting. Through the use of the use of linear light emphasises the basic shape of a building or piece of furniture without disturbing the design language and without itself becoming too obvious in the foreground. In contrast to classic lighting solutions, the view into the room remains unobstructed.



With the kind support of Friese Elektrotechnik, Ettenheim

NOT ALL WHITE IS THE SAME

As with conventional LED luminaires, there are also variants of LED stripes with fixed or variable white temperatures. Not all white is the same! The decisive factor is the colour temperature, which ranges from a bright, cold working light to warm mood and accent lighting. A basic distinction is made between warm white, neutral white and cool white. Warm white light, for example, is suitable for the living room or bedroom, neutral white for bathrooms and kitchens, and cool white for functionally illuminated workrooms. Those who want to remain flexible should look for LED stripes with warm and cool white LEDs so that the colour temperature can be individually adjusted via a controller. For this purpose, LED stripes are available in different versions: 1-channel stripes can only display one colour, 2-channel stripes enable switching between different shades of white.



With the kind support of Friese Elektrotechnik, Ettenheim

In addition to the actual stripe light and the respective profile to cover the stripe, an additional power supply unit and a controller are required for installation - with or without the option of dimming the LEDs, depending on the requirements and design of the LED strip. In the chapter on power supplies, you will find an overview of the different versions. When fully equipped, LED stripes thus offer flexible control over lighting and room moods - from changing light colours to adjusting the light intensity according to the time of day. Whereas for 1-channel stripes a simple switch [on/off] is sufficient, multicoloured light stripes can be conveniently controlled from a smartphone using a radio remote control as well as apps.





Foto: Daniel Vrezer - Architektur fotografie, Karlsruhe

MADE TO MEASURE

A final tip: DEKO-LIGHT offers a comprehensive assembly service [p. 14] for linear lighting solutions. Plan your projects individually, reduce your installation time, avoid sources of error and use your LED stripes, including the appropriate profiles, in your projects.



Foto: Daniel Wieser - Architektur fotografie, Karlsruhe



Foto: Daniel Wieser - Architektur fotografie, Karlsruhe



U-profiles
flat
from page 700



U-profiles
high
from page 700



T-profiles
flat
from page 712



T-profiles
high
from page 712

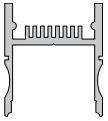

H-profile
high
page 724



slot profile
U-profile
page 726

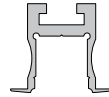

slot profile
T-profile
page 728



slot profile
U-profile
page 730

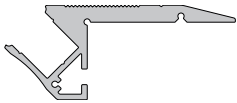

step profile
mounting
page 734

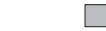

angle profile
angle 45°
page 740

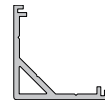

corner profile
mounting
page 744

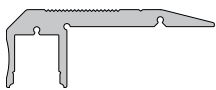

step profile
mounting
page 736



socket profile
mounting
page 738

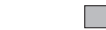

angle profile
angle 135°
page 742



mounting-Profil
mounting | substructure
page 752



corner profile
mounting
from page 754



corner profile
mounting | built-in
page 758



corner profiles
mounting
from page 746



corner profile
mounting
page 750

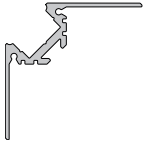

dry construction profile
outside corner
page 764

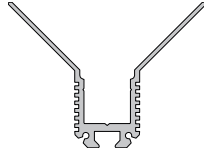

dry construction profile
inside corner
page 766

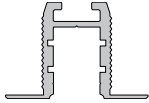

dry construction profile
wall, ceiling
page 768

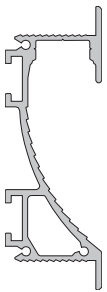

dry construction profile
wall cove
page 762

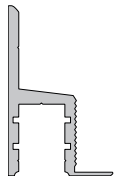

dry construction profile
ceiling cove
page 770

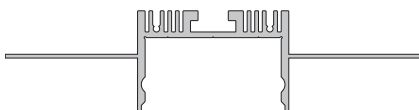

dry construction profile
wall, ceiling
page 772

aluminium profiles



tile profiles
built-in | closing
from page 776

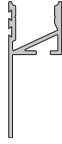

tile profile
closing
page 780

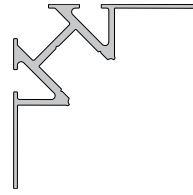

tile profiles
inside corner
from page 782

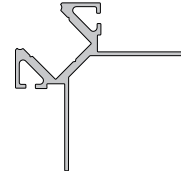

tile profiles
outside corner
from page 786



profile for outdoor
built-in | mounting
page 792



profile for outdoor
built-in
page 794

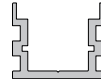

profile for outdoor
built-in | mounting
page 796

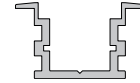

profile for outdoor
built-in
page 798

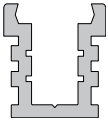

profiles for outdoor
built-in | passable
page 800

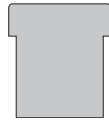

profiles for outdoor
complete set | IP67 | passable
page 805



ASSEMBLY FOR PROFILES & STRIPES

We provide our products individually made to measure on request.
You will receive the prices on request.



989100 – service package I – profile cut

profile is shortened to desired length, tolerance ± 1 mm | sawing loss 4 mm

989105 – drill hole end cap / profile

hole for cable outlet in end cap or profile



989200 – service package II – cover cut

cover is shortened to desired length, tolerance ± 1 mm | sawing loss 4 mm



989300 – service package III – stripe cut

LED stripe is adapted to desired length, taking into account segment and maximum total length, including soldering of a cable lead of the desired length and open, tinned wire ends

989305 – cable – connecting cable / cores 1 channel

989310 – cable – connecting cable / cores 2 channel

989315 – cable – connecting cable / cores 3 + 4 channel

989320 – cable – mini cable / cores 1 - 4 channel

989325 – cable – connecting cable / cores 5 channel

989301 – 2nd connecting cable

attachment of a 2nd connecting cable / cores for further connection with open tinned wire ends

989302 – connecting cable

attaching / soldering a fixed connection line / cores between 2 stripe pieces

[max. 1m connection line / cores incl., a longer connection will be charged by the metre]

original length and max. total length of the strip to be operated may not be exceeded by sections be exceeded

989350 – IP surcharge – sealing stripe

sealing a shortened IP stripe / gluing an end cap



989400 – service package IV – complete assembly

bringing together and assembling all components into a finished luminaire
incl. function test and cable flag

[for desired length, please add 2cm to the cut length of the LED stripe segment
for connection space, length tolerance ± 2 mm]



CONFIGURATOR – UNRIVALLED FLEXIBILITY

Linear light is the lighting trend of the moment! So that you know exactly which LED strips and profiles are suitable for your project and which dimensions and quantities you need, there is our online configurator. Enter your individual application data and choose from our strips, profiles, covers, end caps and more – the configurator does the rest for you.



available end of 2021



HOMOGENEOUS LIGHT IMAGE

How to achieve a homogeneous light image

In combination with a milky 40% cover and a matching LED stripe, a homogeneous light image can be created. The distance [pixel pitch] between the LEDs and the cover is decisive.

The rule of thumb here is:

The distance between the LEDs should be smaller than the distance between the LEDs and the cover.

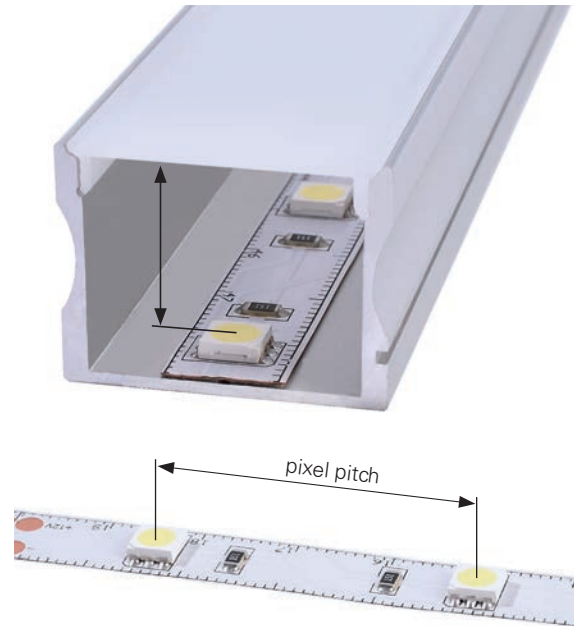

PROFILE DESCRIPTION

mounting type: A = mounting
E = built-in

Width of the series [10 profile] / of the matching LED stripe

AU - 01 - 10

basic form

series

TRANSLUCENCY / LIGHT TRANSMISSION

95% clear

75% matt

40% milky

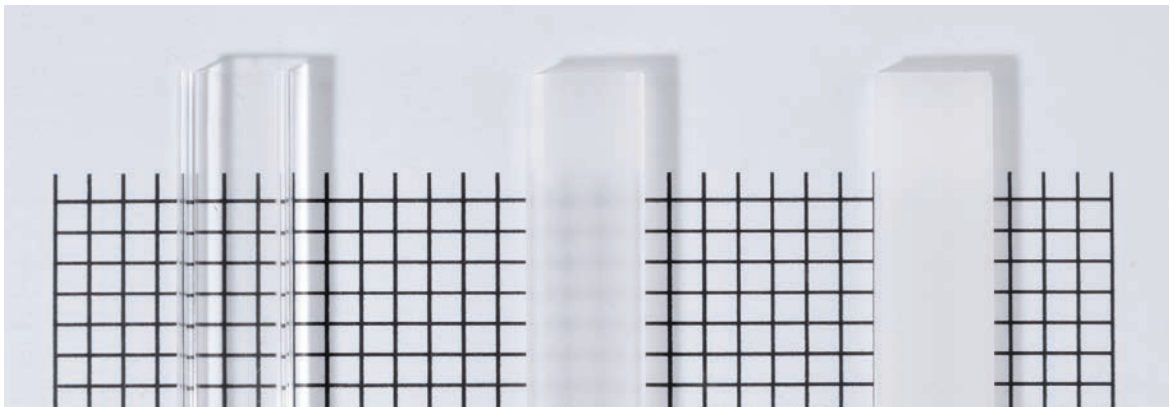
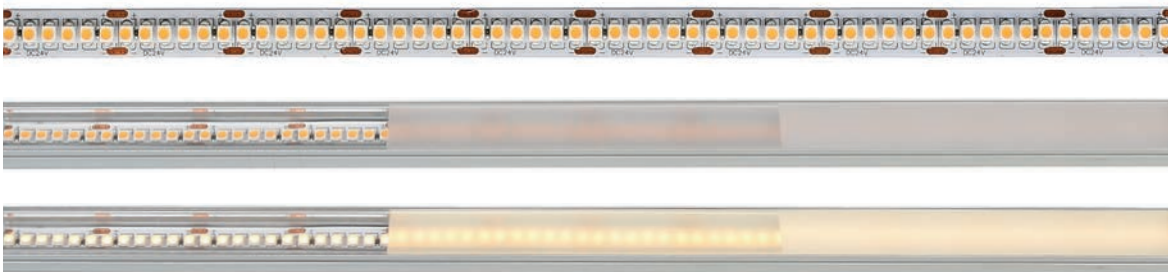

Illustration of various LED stripes with different pixel pitches in combination with three different light transmittances in the covers. This small selection clearly illustrates the optical differences of some LED stripes in combination with different covers.

120 LED/m
cutting option 50 mm / 6 LED



240 LED/m
cutting option 25 mm / 6 LED



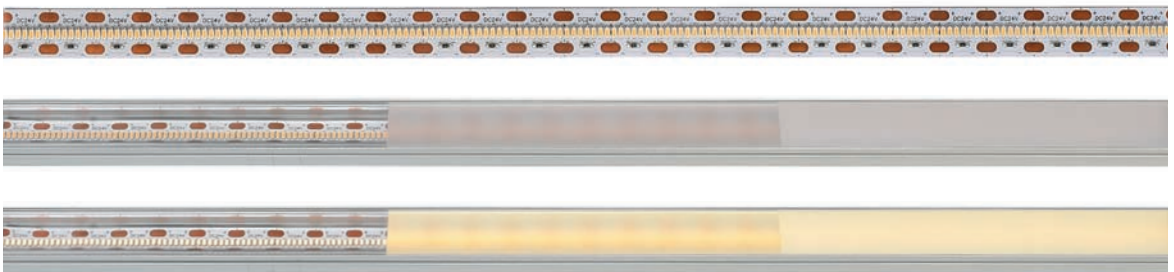

700LED/m
cutting option 10 mm / 7 LED





COB 480 LED/m
cutting option 50 mm / 24 LED















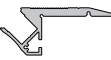





	1m	2m	3m	4m	item number	page
AU-01-05 LED stripes ≤ 5,7 mm 	x				970080	700
		x			970081	
	x				970082	
		x			970083	
	x				970084	
		x			970085	
				970086		
AU-01-08 LED stripes ≤ 9,3 mm	x				970000	702
		x			970001	
			x		970008	
	x				970002	
		x			970003	
	x				970004	
		x			970005	
	x			970007		
AU-01-10 LED stripes ≤ 11,3 mm	x				970020	704
		x			970021	
			x		970028	
				x	970029	
	x				970022	
		x			970023	
		x			970025	
	x				970026	
	x			970027		
AU-01-12 LED stripes ≤ 13,3 mm	x				970040	706
		x			970041	
			x		970048	
	x				970042	
		x			970043	
	x				970044	
		x			970045	
x				970046		
	x			970047		
AU-01-15 LED stripes ≤ 16,3 mm	x				970060	708
		x			970061	
			x		970068	
	x				970062	
		x			970063	
	x				970064	
		x			970065	
x				970066		
	x			970067		







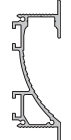

	1m	2m	3m	4m	item number	page
AU-02-05 LED stripes ≤ 5,7 mm 	x				970180	700
		x			970181	
	x				970182	
		x			970183	
	x				970184	
		x			970185	
					970186	
				970187		
AU-02-08 LED stripes ≤ 9,3 mm	x				970100	702
		x			970101	
			x		970108	
	x				970102	
		x			970103	
	x				970104	
		x			970105	
	x			970106		
				970107		
AU-02-10 LED stripes ≤ 11,3 mm	x				970120	704
		x			970121	
			x		970128	
				x	970129	
	x				970122	
		x			970123	
		x			970125	
	x				970126	
	x			970127		
AU-02-12 LED stripes ≤ 13,3 mm	x				970140	706
		x			970141	
			x		970148	
	x				970142	
		x			970143	
	x				970144	
		x			970145	
x				970146		
	x			970147		
AU-02-15 LED stripes ≤ 16,3 mm	x				970160	708
		x			970161	
			x		970168	
	x				970162	
		x			970163	
	x				970164	
		x			970165	
x				970166		
	x			970167		
AU-02-20 LED stripes ≤ 21,3 mm	x				970200	710
		x			970201	
			x		970202	
				x	970205	































	1m	2m	3m	4m	item number	page
ET-01-05 LED stripes ≤ 5,7 mm 	x				975080	712
		x			975081	
	x				975082	
		x			975083	
	x				975084	
		x			975085	
	x				975086	
		x		975087		
ET-01-08 LED stripes ≤ 9,3 mm	x				975000	714
		x			975001	
			x		975008	
	x				975002	
		x			975003	
	x				975004	
		x			975005	
		x		975006		
	x			975007		
ET-01-10 LED stripes ≤ 11,3 mm	x				975020	716
		x			975021	
			x		975028	
				x	975029	
	x				975022	
		x			975023	
		x			975025	
		x		975026		
	x			975027		
ET-01-12 LED stripes ≤ 13,3 mm	x				975040	718
		x			975041	
	x				975042	
		x			975043	
	x				975044	
		x			975045	
		x		975046		
	x			975047		
ET-01-15 LED stripes ≤ 16,3 mm	x				975060	720
		x			975061	
	x				975062	
		x			975063	
	x				975064	
		x			975065	
		x		975066		
	x			975067		

	1m	2m	3m	4m	item number	page
ET-02-05 LED stripes ≤ 5,7 mm 	x				975180	712
		x			975181	
	x				975182	
		x			975183	
	x				975184	
		x			975185	
	x				975186	
		x		975187		
ET-02-08 LED stripes ≤ 9,3 mm	x				975100	714
		x			975101	
			x		975108	
	x				975102	
		x			975103	
	x				975104	
		x			975105	
		x		975106		
	x			975107		
ET-02-10 LED stripes ≤ 11,3 mm	x				975120	716
		x			975121	
			x		975128	
				x	975129	
	x				975122	
		x			975123	
	x				975124	
	x			975125		
		x		975126		
	x			975127		
ET-02-12 LED stripes ≤ 13,3 mm	x				975140	718
		x			975141	
			x		975148	
	x				975142	
		x			975143	
	x				975144	
		x			975145	
		x		975146		
	x			975147		
ET-02-15 LED stripes ≤ 16,3 mm	x				975160	720
		x			975161	
			x		975168	
	x				975162	
		x			975163	
	x				975164	
		x			975165	
		x		975166		
	x			975167		

		1m	1,25m	1,5m	2m	2,5m	3m	item number	page
AH-01-20 LED stripes ≤ 21,3 mm		x						970260	724
					x			970261	
							x	970262	
AU-03-12 LED stripes ≤ 13,3 mm		x						970230	726
					x			970231	
ET-04-12 LED stripes ≤ 13,3 mm		x						975230	728
					x			975231	
AU-10-12 LED stripes ≤ 12 mm					x			970280	730
						x		970281	
					x			970284	
						x		970285	
							x	970286	
AL-01-10 LED stripes ≤ 11,3 mm		x						970500	734
					x			970503	
						x		970502	
							x	970504	
AL-02-10 LED stripes ≤ 11,3 mm		x						970520	736
					x			970523	
						x		970522	
							x	970524	
AM-02-10 LED stripes ≤ 11,3 mm					x			970602	738
						x		970600	
							x	970601	
AV-01-20 LED stripes ≤ 22 mm					x		970460	740	
AV-02-20 LED stripes ≤ 17 mm ≤ 22 mm					x		970470	742	
AV-03-12 LED stripes ≤ 13,3 mm		x						970432	744
			x					970430	
					x			970433	
						x		970431	
							x	970434	
		x						970436	
				x		970437			
					x	970438			

		1m	1,25m	1,5m	2m	2,5m	3m	item number	page	
AV-05-12 LED stripes ≤ 12,5 mm					x			■ 970550	746	
							x	■ 970551		
AV-05-15 LED stripes ≤ 15,4 mm					x			■ 970560	748	
							x	■ 970561		
AV-05-25 LED stripes ≤ 25,5 mm					x			■ 970570	750	
							x	■ 970571		
AM-01-10 LED stripes ≤ 11,3 mm		x						■ 970300	752	
					x			■ 970301		
							x		■ 970308	
		x							■ 970302	
					x				■ 970303	
		x							□ 970304	
					x				□ 970305	
AV-01-10 LED stripes ≤ 11,3 mm		x						□ 970306		
					x			□ 970307		
					x				■ 970401	754
							x		■ 970404	
					x				□ 970403	
							x		■ 970405	
		AV-04-12 LED stripes ≤ 13,3 mm		x						■ 970410
					x			■ 970411		
							x		■ 970414	
					x				□ 970413	
EV-04-12 LED stripes ≤ 13,3 mm					x			■ 975411	758	
							x	■ 975412		
EL-02-12 LED stripes ≤ 14 mm		x						■ 975490	762	
					x			■ 975491		
							x		■ 975496	
		x							□ 975494	
					x				□ 975495	
AV-02-10 LED stripes ≤ 11,3 mm							x	■ 975498		
					x			■ 970450	764	
							x	■ 970455		
EV-03-10 LED stripes ≤ 12 mm						x		□ 970452		
					x			■ 975460	766	
						x		□ 975462		

		1m	1,25m	1,5m	2m	2,5m	3m	item number	page	
ET-03-10 LED stripes ≤ 12 mm			x					<input checked="" type="checkbox"/> 975470	768	
						x		<input checked="" type="checkbox"/> 975471		
							x	<input checked="" type="checkbox"/> 975476		
			x					<input type="checkbox"/> 975474		
						x		<input type="checkbox"/> 975475		
EL-03-10 LED stripes ≤ 12 mm					x			<input checked="" type="checkbox"/> 975483	770	
						x		<input checked="" type="checkbox"/> 975481		
							x	<input checked="" type="checkbox"/> 975486		
							x	<input type="checkbox"/> 975485		
EU-01-36 LED stripes ≤ 36 mm							x	<input checked="" type="checkbox"/> 975501	772	
EL-01-08 LED stripes ≤ 9,3 mm						x		<input checked="" type="checkbox"/> 975331	776	
							x	<input checked="" type="checkbox"/> 975334		
EL-03-12 LED stripes ≤ 13,3 mm			x					<input checked="" type="checkbox"/> 975360	778	
							x	<input checked="" type="checkbox"/> 975361		
			x							<input type="checkbox"/> 975364
							x			<input type="checkbox"/> 975365
							x			<input type="checkbox"/> 975367
							x			<input checked="" type="checkbox"/> 975369
EA-03-12 LED stripes ≤ 12 mm					x			<input checked="" type="checkbox"/> 975390	780	
							x	<input checked="" type="checkbox"/> 975391		
					x					<input type="checkbox"/> 975394
								x		<input type="checkbox"/> 975395
EV-01-08 LED stripes ≤ 9,3 mm					x			<input checked="" type="checkbox"/> 975343	782	
						x		<input checked="" type="checkbox"/> 975341		
							x			<input checked="" type="checkbox"/> 975344
								x		<input checked="" type="checkbox"/> 975345
EV-01-12 LED stripes ≤ 13,3 mm			x					<input checked="" type="checkbox"/> 975370	784	
							x	<input checked="" type="checkbox"/> 975371		
						x				<input type="checkbox"/> 975375
			x							<input type="checkbox"/> 975376
							x			<input type="checkbox"/> 975377
							x			<input checked="" type="checkbox"/> 975379
EV-02-08 LED stripes ≤ 9,3 mm			x					<input checked="" type="checkbox"/> 975350	786	
						x		<input checked="" type="checkbox"/> 975352		
							x			<input checked="" type="checkbox"/> 975351
								x		<input checked="" type="checkbox"/> 975353

		1m	1,25m	1,5m	2m	2,5m	3m	item number	page	
EV-02-12 LED stripes ≤ 13,3 mm						x		 975381	788	
			x					 975384		
						x			 975385	
							x		 975389	
AU-04-12 LED stripes ≤ 12,3 mm		x						 970722	792	
			x					 970720		
					x				 970723	
						x			 970721	
							x		 970724	
								x	 970725	
ET-05-12 LED stripes ≤ 12,3 mm		x						 975722	794	
			x					 975720		
					x				 975723	
						x			 975721	
							x		 975724	
AU-05-15 LED stripes ≤ 15,6 mm		x						 970740	796	
					x			 970741		
ET-05-15 LED stripes ≤ 15,6 mm		x						 975740	798	
					x			 975741		
EU-01-12 LED stripes ≤ 12,3 mm					x			 975781	800	
complete set LITUS		x						 847015	805	
					x			 847016		
		x						 847017		
				x			 847018			

 aluminium | anodized

 black mat | brushed

 white mat

 aluminium | brushed

 aluminium | natural

profile width
-08 plan



profile width	1m	2m	3m	4m	95%	75%	40%	item number
x					x			983000
	x				x			983001
		x			x			983006
x						x		983002
	x					x		983003
		x				x		983007
x							x	983004
	x						x	983005
		x					x	983008
x					x			983010
	x				x			983011
		x			x			983016
			x	x				983060
x						x		983012
	x					x		983013
		x				x		983017
			x			x		983061
x							x	983014
	x						x	983015
		x					x	983018
			x				x	983062
x					x			983020
	x				x			983021
		x			x			983028
x						x		983022
	x					x		983023
		x				x		983027
x							x	983024
	x						x	983025
		x					x	983026
	x						x	983100
		x					x	983101
x					x			983030
	x				x			983031
		x			x			983038
x						x		983032
	x					x		983033
		x				x		983037
x							x	983034
	x						x	983035
		x					x	983036

-10 plan



-12 plan



-12 plan



-15 plan



profile width
-15 plan



-20 plan



-25 plan



-36 plan



-05 flat



-08 flat



-10 flat



profile width	1m	2m	3m	4m	95%	75%	40%	item number
		x					x	983110
			x				x	983111
x					x			983040
	x				x			983041
x							x	983044
	x						x	983045
		x					x	983046
	x						x	983120
		x					x	983121
			x				x	985601
x					x			983550
	x				x			983551
x							x	983554
	x						x	983555
		x					x	983556
x					x			983500
	x				x			983501
x						x		983502
	x					x		983503
x							x	983504
	x						x	983505
		x					x	983506
x					x			983510
	x				x			983511
		x			x			983516
			x	x				983560
x						x		983512
	x					x		983513
		x				x		983517
			x			x		983561
x							x	983514
	x						x	983515
		x					x	983518
			x				x	983562

profile width

-12 flat



	1m	2m	3m	4m	95%	75%	40%	item number
x					x			983520
	x				x			983521
		x			x			983527
x						x		983522
	x					x		983523
x							x	983524
	x						x	983525
		x					x	983526
x					x			983530
	x				x			983531
x						x		983532
	x					x		983533
		x				x		983539
x							x	983534
	x						x	983535
		x					x	983536
x							x	984054
	x						x	984055
x						x		984002
	x					x		984003
x							x	984004
	x						x	984005
x						x		984012
	x					x		984013
		x				x		984017
			x			x		984010
x							x	984014
	x						x	984015
		x					x	984018
			x				x	984011
x						x		984022
	x					x		984023
x							x	984024
	x						x	984025
		x					x	984026

-15 flat



-05 high



-08 high



-10 high



-12 high



profile width

-15 high



-20 high



-05 round



-08 round



-10 round



-12 round



-12 round













-12 round







-15 round



	1m	2m	3m	4m	95%	75%	40%	item number
x						x		984032
	x					x		984033
x							x	984034
	x						x	984035
		x					x	984036
x							x	984044
	x						x	984045
x							x	984554
	x						x	984555
x						x		984502
	x					x		984503
x							x	984504
	x						x	984505
x						x		984512
	x					x		984513
		x				x		984517
			x			x		984510
x							x	984514
	x						x	984515
		x					x	984518
			x				x	984511
x						x		984522
	x					x		984523
x							x	984524
	x						x	984525
		x					x	984526
	x						x	984565
		x					x	984568
x							x	984570
		x					x	984571
x						x		984532
	x					x		984533
x							x	984534
	x						x	984535

profile width	1m	2m	3m	4m	95%	75%	40%	item number
-15 round 		x					x	984580
			x				x	984581
-20 round 	x						x	984544
		x					x	984545
-25 round 		x					x	984590
			x				x	984591
-10 lens 	x				x			985010
		x			x			985011
			x		x			985016
-10 inside corner 	x						x	985554
		x					x	985555
			x				x	985558
-08 outside corner 	x						x	985504
		x					x	985505
			x				x	985508
-10 outside corner 	x						x	985514
		x					x	985515
			x				x	985518
-12 outside corner 		x					x	985570
			x				x	985571
-15 outside corner 		x					x	985580
			x				x	985581
-25 outside corner 		x					x	985590
			x				x	985591

profile width	1m	2m	3m	4m	95%	75%	40%	item number
-10 walkable 	x						x	983080
		x					x	983081
			x				x	983082
-12 for AU-10-12 			x				x	983090
				x			x	983091
-12 IP walkable 		x					x	988025
			x				x	988028
-12 IP passable 	x						x	988054
		x					x	988055
-15 IP walkable 	x						x	988084
		x					x	988085

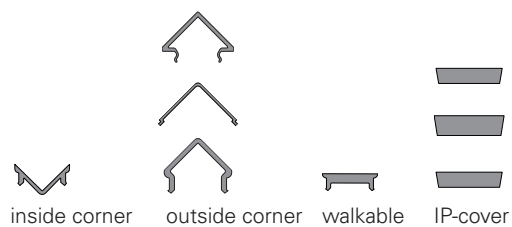
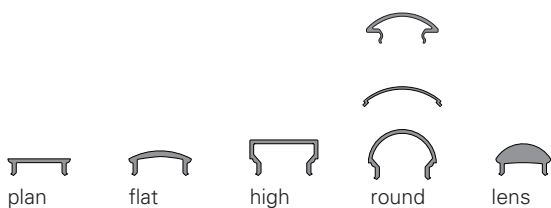

PROFILE STANDARD SURFACES



aluminium anodized



black mat brushed



white mat



aluminium brushed



aluminium natural

POWDER COATING DESIRED COLOUR ACCORDING TO RAL

Would you like one of our profiles in the colour of your choice? No problem! All aluminium profiles are also available powder-coated in the RAL colour of your choice.



989900 – powder coating – RAL colour
Ordering and invoicing by the metre.
minimum order quantity and price on request

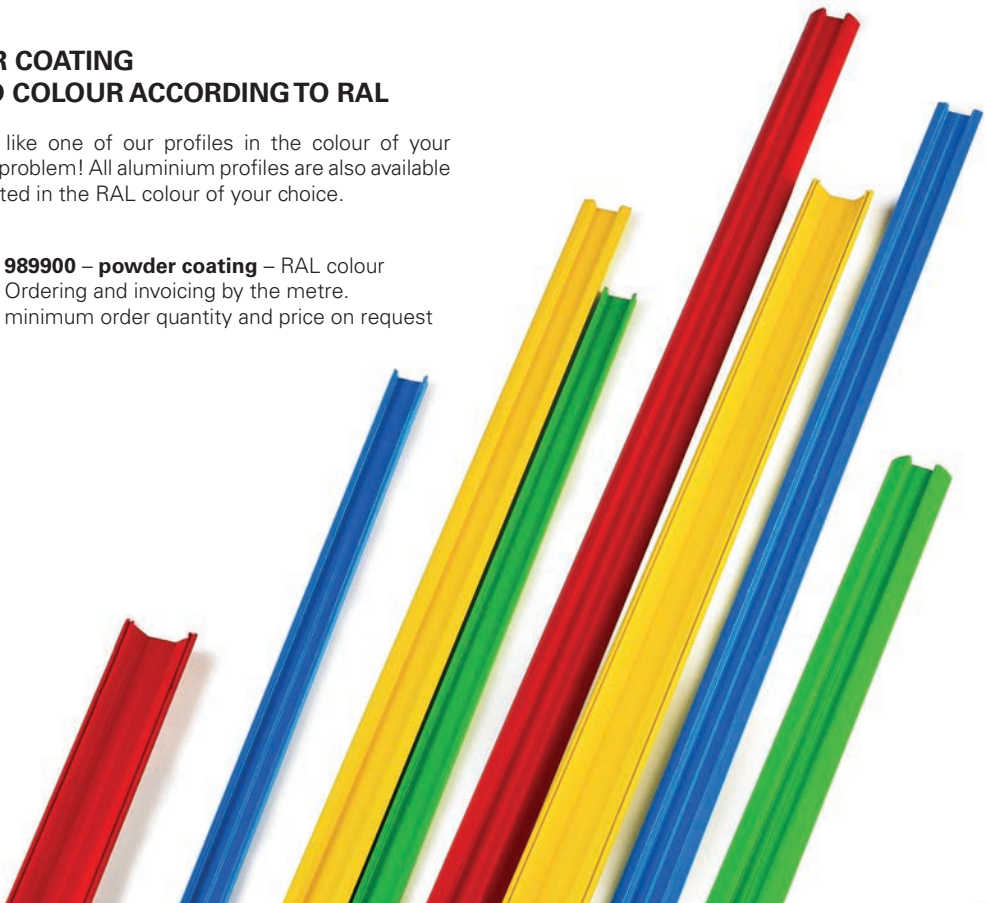



With the kind support of BEST Bellemann Elektro Service Team GmbH, Rauenberg-Malschenberg









U- and T-profiles

The profiles of these series are available in various designs. Thanks to their universal profile shape, they can be used flexibly in almost all areas. Thanks to their profile construction, they are ideally suited for the cover cut edges.

AU-01-05

flat U-profile

for LED stripes up to 5,7 mm width

970080		1m aluminium anodized	6,95 €
970081		2m aluminium anodized	12,95 €
970082		1m black mat brushed	6,95 €
970083		2m black mat brushed	12,95 €
970084		1m white mat	6,95 €
970085		2m white mat	12,95 €
970086		1m aluminium brushed	6,95 €

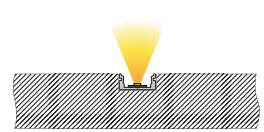
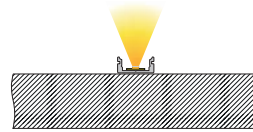
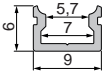

AU-02-05

high U-profile

for LED stripes up to 5,7 mm width

970180		1m aluminium anodized	7,95 €
970181		2m aluminium anodized	14,95 €
970182		1m black mat brushed	7,95 €
970183		2m black mat brushed	14,95 €
970184		1m white mat	7,95 €
970185		2m white mat	14,95 €
970186		1m aluminium brushed	7,95 €
970187		2m aluminium brushed	14,95 €

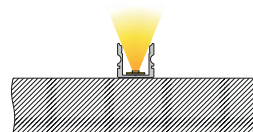
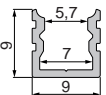

covers | PMMA [Polymethylmethacrylat]

clear matt milky



1m	983550	983554	4,95 €
2m	983551	983555	9,95 €
3m		983556	14,95€



1m		984054	4,95 €
2m		984055	9,95 €



1m		984554	4,95 €
2m		984555	9,95 €

end caps set | 2 pieces **3,95 €**

- white
- grey
- black



- 978660**
- 978661**
- 978662**



- 978670**
- 978671**
- 978672**



- white
- grey
- black

- 979160**
- 979161**
- 979162**



- 979170**
- 979171**
- 979172**



- white
- grey
- black

- 979660**
- 979661**
- 979662**



- 979670**
- 979671**
- 979672**



930345 3M double-sided tape | 50 m x 8 mm

13,95 €

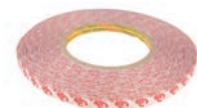

AU-01-08





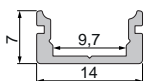



flat U-profile
for LED stripes up to 9,3 mm width

970000		1m aluminium anodized	9,95 €
970001		2m aluminium anodized	19,95 €
970008		3m aluminium anodized	29,95 €
970002		1m black mat brushed	9,95 €
970003		2m black mat brushed	19,95 €
970004		1m white mat	9,95 €
970005		2m white mat	19,95 €
970007		2m aluminium brushed	19,95 €



AU-02-08



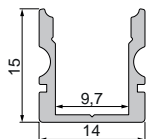

high U-profile
for LED stripes up to 9,3 mm width

970100		1m aluminium anodized	11,95 €
970101		2m aluminium anodized	23,95 €
970108		3m aluminium anodized	35,95 €
970102		1m black mat brushed	11,95 €
970103		2m black mat brushed	23,95 €
970104		1m white mat	11,95 €
970105		2m white mat	23,95 €
970106		1m aluminium brushed	11,95 €
970107		2m aluminium brushed	23,95 €



















covers | PMMA [Polymethylmethacrylat]

end caps set | 2 pieces **3,95 €**

	clear	matt	milky	
				
1m	983000	983002	983004	6,95 €
2m	983001	983003	983005	13,95 €
3m	983006	983007	983008	20,95 €
				
1m	983500	983502	983504	6,95 €
2m	983501	983503	983505	13,95 €
3m			983506	20,95 €
				
1m		984002	984004	6,95 €
2m		984003	984005	13,95 €
				
1m		984502	984504	6,95 €
2m		984503	984505	13,95 €

-  white
-  grey
-  black

			
978000		978040	
978001		978041	
978002		978042	
			
978500		978540	
978501		978541	
978502		978542	
			
979080		979100	
979081		979101	
979082		979102	
			
979580		979600	
979581		979601	
979582		979602	

987002 fixation clamp 08 | set consisting of 2 pieces **2,95 €**



987080 universal mounting clip brackets [pivotable] set, 2 pieces | matching fixation clamp must be ordered separately **19,95 €**











930347 3M double-sided tape | 50 m x 12 mm **15,95 €**



AU-01-10

flat U-profile

for LED stripes up to 11,3 mm width



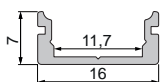





970020		1m aluminium anodized	9,95 €
970021		2m aluminium anodized	19,95 €
970028		3m aluminium anodized	29,95 €
970029		4m aluminium anodized	39,95 €
970022		1m black mat brushed	9,95 €
970023		2m black mat brushed	19,95 €
970025		2m white mat	19,95 €
970026		1m aluminium brushed	9,95 €
970027		2m aluminium brushed	19,95 €



AU-02-10



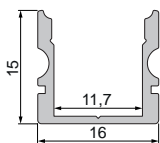

high U-profile

for LED stripes up to 11,3 mm width











970120		1m aluminium anodized	11,95 €
970121		2m aluminium anodized	23,95 €
970128		3m aluminium anodized	35,95 €
970129		4m aluminium anodized	47,95 €
970122		1m black mat brushed	11,95 €
970123		2m black mat brushed	23,95 €
970125		2m white mat	23,95 €
970126		1m aluminium brushed	11,95 €
970127		2m aluminium brushed	23,95 €



covers | PMMA [Polymethylmethacrylat]

	clear	matt	milky	
				
1m	983010	983012	983014	6,95 €
2m	983011	983013	983015	13,95 €
3m	983016	983017	983018	20,95 €
4m	983060	983061	983062	27,95 €
				
1m	983510	983512	983514	6,95 €
2m	983511	983513	983515	13,95 €
3m	983516	983517	983518	20,95 €
4m	983560	983561	983562	27,95 €
				
1m		984012	984014	6,95 €
2m		984013	984015	13,95 €
3m		984017	984018	20,95 €
4m		984010	984011	27,95 €
				
1m		984512	984514	6,95 €
2m		984513	984515	13,95 €
3m		984517	984518	20,95 €
4m		984510	984511	27,95 €
				
1m	985010			6,95 €
2m	985011			13,95 €
3m	985016			20,95 €

end caps set | 2 pieces 3,95 €

	white	grey	black	
				
	978010	978011	978012	
				
	978510	978511	978512	
				
	979000	979001	979002	
				
	979500	979501	979502	
				
	980000	980001	980002	

987004 fixation clamp 10 | set consisting of 2 pieces **2,95 €**



987080 universal mounting clip brackets [pivotable] set, 2 pieces | matching fixation clamp must be ordered separately **19,95 €**





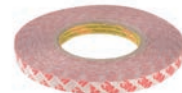





930348 3M double-sided tape | 50 m x 15 mm **18,95 €**



AU-01-12

flat U-profile

for LED stripes up to 13,3 mm width



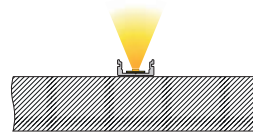
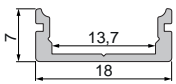





970040		1m aluminium anodized	11,95 €
970041		2m aluminium anodized	23,95 €
970048		3m aluminium anodized	35,95 €
970042		1m black mat brushed	11,95 €
970043		2m black mat brushed	23,95 €
970044		1m white mat	11,95 €
970045		2m white mat	23,95 €
970046		1m aluminium brushed	11,95 €
970047		2m aluminium brushed	23,95 €



AU-02-12

high U-profile



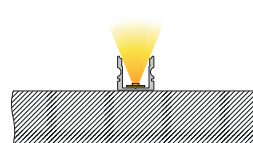
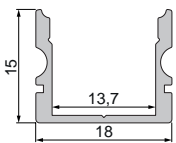

for LED stripes up to 13,3 mm width

970140		1m aluminium anodized	12,95 €
970141		2m aluminium anodized	25,95 €
970148		3m aluminium anodized	38,95 €
970142		1m black mat brushed	12,95 €
970143		2m black mat brushed	25,95 €
970144		1m white mat	12,95 €
970145		2m white mat	25,95 €
970146		1m aluminium brushed	12,95 €
970147		2m aluminium brushed	25,95 €



















covers | PMMA [Polymethylmethacrylat]

end caps set | 2 pieces 3,95 €

	clear	matt	milky	
				
1m	983020	983022	983024	6,95 €
2m	983021	983023	983025	13,95 €
3m	983028	983027	983026	20,95 €
				
1m	983520	983522	983524	6,95 €
2m	983521	983523	983525	13,95 €
3m	983527	983526	983526	20,95 €
				
1m		984022	984024	6,95 €
2m		984023	984025	13,95 €
3m			984026	20,95 €
				
1m		984522	984524	6,95 €
2m		984523	984525	13,95 €
3m			984526	20,95 €

-  white
-  grey
-  black

			
978020	978021	978022	978060
978020	978021	978022	978060
			
978520	978521	978522	978560
978520	978521	978522	978560
			
979010	979011	979012	979030
979010	979011	979012	979030
			
979510	979511	979512	979530
979510	979511	979512	979530

987006 fixation clamp 12 | set consisting of 2 pieces **2,95 €**



987080 universal mounting clip brackets [pivotable] set, 2 pieces | matching fixation clamp must be ordered separately **19,95 €**











930348 3M double-sided tape | 50 m x 15 mm **18,95 €**



AU-01-15

flat U-profile

for LED stripes up to 16,3 mm width



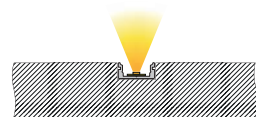
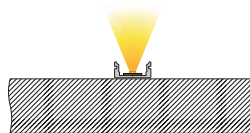
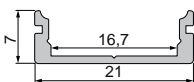





970060		1m aluminium anodized	11,95 €
970061		2m aluminium anodized	23,95 €
970068		3m aluminium anodized	35,95 €
970062		1m black mat brushed	11,95 €
970063		2m black mat brushed	23,95 €
970064		1m white mat	11,95 €
970065		2m white mat	23,95 €
970066		1m aluminium brushed	11,95 €
970067		2m aluminium brushed	23,95 €



AU-02-15

high U-profile

for LED stripes up to 16,3 mm width

970160		1m aluminium anodized	12,95 €
970161		2m aluminium anodized	25,95 €
970168		3m aluminium anodized	38,95 €
970162		1m black mat brushed	12,95 €
970163		2m black mat brushed	25,95 €
970164		1m white mat	12,95 €
970165		2m white mat	25,95 €
970166		1m aluminium brushed	12,95 €
970167		2m aluminium brushed	25,95 €

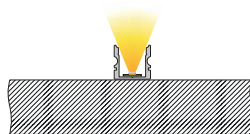
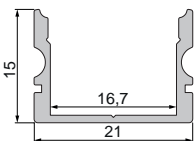



covers | PMMA [Polymethylmethacrylat]

clear matt milky

				
1m	983030	983032	983034	7,95 €
2m	983031	983033	983035	15,95 €
3m	983038	983037	983036	23,95 €

				
1m	983530	983532	983534	7,95 €
2m	983531	983533	983535	15,95 €
3m		983539	983536	23,95 €

				
1m		984032	984034	7,95 €
2m		984033	984035	15,95 €
3m			984036	23,95 €

				
1m		984532	984534	7,95 €
2m		984533	984535	15,95 €

end caps set | 2 pieces 3,95 €

 white
 grey
 black

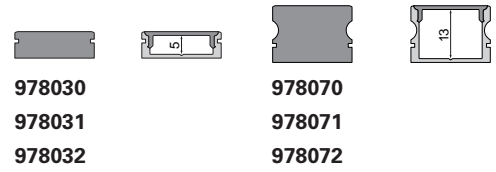

 white
 grey
 black

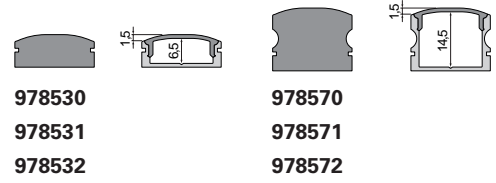

 white
 grey
 black

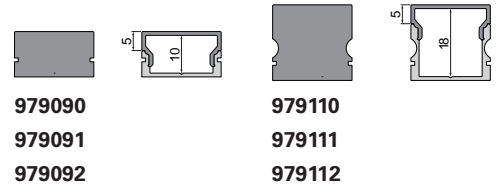

 white
 grey
 black

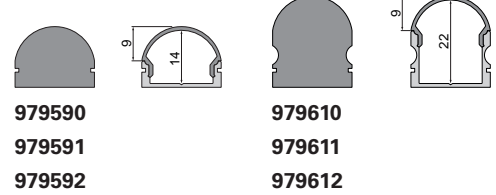

987008 fixation clamp 15 | set consisting of 2 pieces **2,95 €**



987080 universal mounting clip brackets [pivotable] set, 2 pieces | matching fixation clamp must be ordered separately **19,95 €**



930349 3M double-sided tape | 50 m x 20 mm **26,95 €**



AU-02-20

high U-profile

for LED stripes up to 21,3 mm width

970200	■	1m aluminium anodized	15,95 €
970201	■	2m aluminium anodized	31,95 €
970202	■	3m aluminium anodized	47,95 €
970205	■	3m aluminium natural	47,95 €

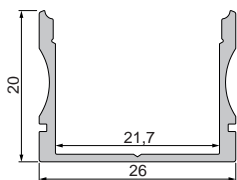

With the kind support of Friese Elektrotechnik, Ettenheim

covers | PMMA [Polymethylmethacrylat]

clear matt milky



1m	983040	983044	8,95 €
2m	983041	983045	17,95 €
3m		983046	26,95 €



1m		984044	8,95 €
2m		984045	17,95 €



1m		984544	8,95 €
2m		984545	17,95 €

end caps set | 2 pieces **3,95 €**

grey

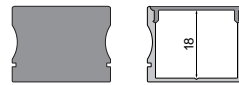

978161

grey

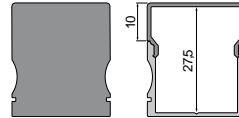

978351

grey

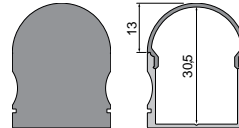

978361

987010 fixation clamp 20 | set consisting of 2 pieces **2,95 €**

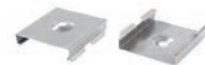

987080 universal mounting clip brackets [pivotable] set, 2 pieces | matching fixation clamp must be ordered separately **19,95 €**



930350 3M double-sided tape | 50 m x 25 mm **32,95 €**

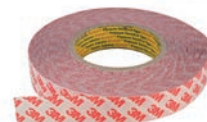

ET-01-05

flat T-profile
for LED stripes up to 5,7 mm width

975080		1m aluminium anodized	6,95 €
975081		2m aluminium anodized	13,95 €
975082		1m black mat brushed	6,95 €
975083		2m black mat brushed	13,95 €
975084		1m white mat	6,95 €
975085		2m white mat	13,95 €
975086		1m aluminium brushed	6,95 €
975087		2m aluminium brushed	13,95 €

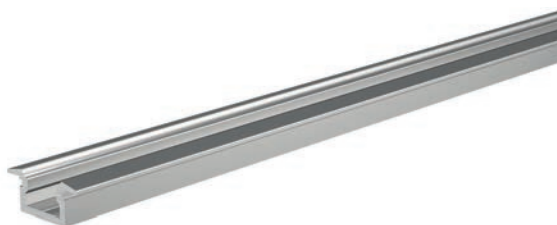
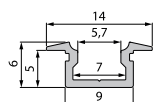

ET-02-05

high T-profile
for LED stripes up to 5,7 mm width

975180		1m aluminium anodized	7,95 €
975181		2m aluminium anodized	15,95 €
975182		1m black mat brushed	7,95 €
975183		2m black mat brushed	15,95 €
975184		1m white mat	7,95 €
975185		2m white mat	15,95 €
975186		1m aluminium brushed	7,95 €
975187		2m aluminium brushed	15,95 €

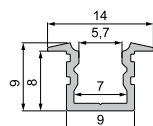

covers | PMMA [Polymethylmethacrylat]

clear matt milky



1m	983550	983554	4,95 €
2m	983551	983555	9,95 €
3m		983556	14,95€



1m		984054	4,95 €
2m		984055	9,95 €



1m		984554	4,95 €
2m		984555	9,95 €

end caps set | 2 pieces **3,95 €**

- white
- grey
- black

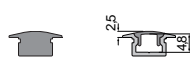

- 978680**
- 978681**
- 978682**

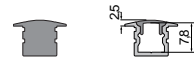

- 978690**
- 978691**
- 978692**

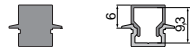

- white
- grey
- black

- 979180**
- 979181**
- 979182**

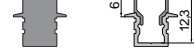

- 979190**
- 979191**
- 979192**

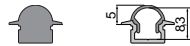

- white
- grey
- black

- 979680**
- 979681**
- 979682**

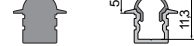

- 979690**
- 979691**
- 979692**





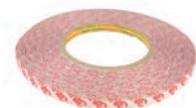



930345 3M double-sided tape | 50 m x 8 mm

13,95 €



ET-01-08





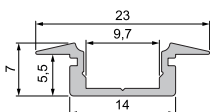



flat T-profile
for LED stripes up to 9,3 mm width

975000		1m aluminium anodized	10,95 €
975001		2m aluminium anodized	21,95 €
975008		3m aluminium anodized	32,95 €
975002		1m black mat brushed	10,95 €
975003		2m black mat brushed	21,95 €
975004		1m white mat	10,95 €
975005		2m white mat	21,95 €
975006		1m aluminium brushed	10,95 €
975007		2m aluminium brushed	21,95 €



ET-02-08

high T-profile
for LED stripes up to 9,3 mm width

975100		1m aluminium anodized	12,95 €
975101		2m aluminium anodized	25,95 €
975108		3m aluminium anodized	38,95 €
975102		1m black mat brushed	12,95 €
975103		2m black mat brushed	25,95 €
975104		1m white mat	12,95 €
975105		2m white mat	25,95 €
975106		1m aluminium brushed	12,95 €
975107		2m aluminium brushed	25,95 €

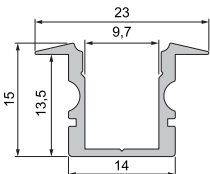
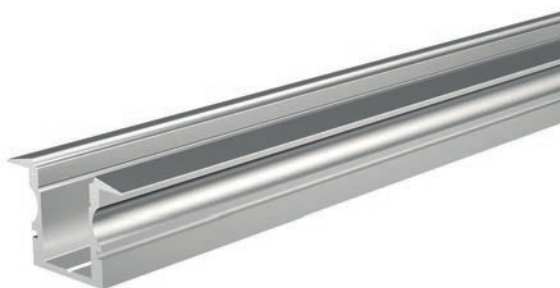



covers | PMMA [Polymethylmethacrylat]

clear matt milky

				
1m	983000	983002	983004	6,95 €
2m	983001	983003	983005	13,95 €
3m	983006	983007	983008	20,95 €

				
1m	983500	983502	983504	6,95 €
2m	983501	983503	983505	13,95 €
3m			983506	20,95 €

				
1m		984002	984004	6,95 €
2m		984003	984005	13,95 €

				
1m		984502	984504	6,95 €
2m		984503	984505	13,95 €

end caps set | 2 pieces 3,95 €

-  white
-  grey
-  black

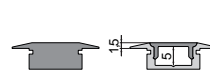

- 978080**
- 978081**
- 978082**

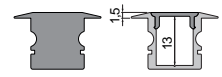

- 978120**
- 978121**
- 978122**

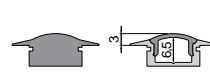

-  white
-  grey
-  black

- 978580**
- 978581**
- 978582**

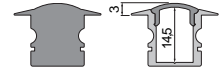

- 978620**
- 978621**
- 978622**

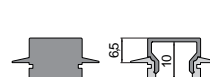

-  white
-  grey
-  black

- 979120**
- 979121**
- 979122**

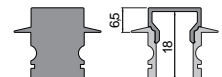

- 979140**
- 979141**
- 979142**

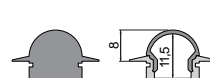

-  white
-  grey
-  black

- 979620**
- 979621**
- 979622**



- 979640**
- 979641**
- 979642**

987002 fixation clamp 08 | set consisting of 2 pieces **2,95 €**



987080 universal mounting clip brackets [pivotable] set, 2 pieces | matching fixation clamp must be ordered separately **19,95 €**



930347 3M double-sided tape | 50 m x 12 mm **15,95 €**

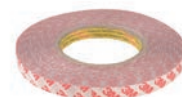

ET-01-10

flat T-profile
for LED stripes up to 11,3 mm width

975020	■	1m aluminium anodized	10,95 €
975021	■	2m aluminium anodized	21,95 €
975028	■	3m aluminium anodized	32,95 €
975029	■	4m aluminium anodized	43,95 €
975022	■	1m black mat brushed	10,95 €
975023	■	2m black mat brushed	21,95 €
975025	□	2m white mat	21,95 €
975026	■	1m aluminium brushed	10,95 €
975027	■	2m aluminium brushed	21,95 €

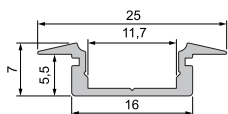



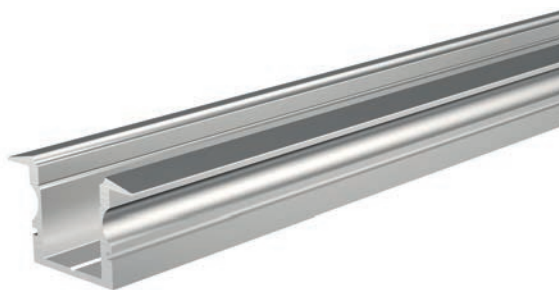
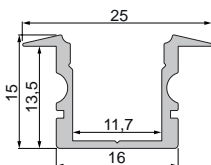

ET-02-10

high T-profile
for LED stripes up to 11,3 mm width













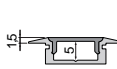

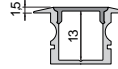



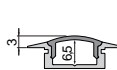

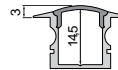



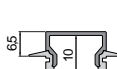

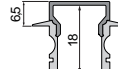

975120	■	1m aluminium anodized	12,95 €
975121	■	2m aluminium anodized	25,95 €
975128	■	3m aluminium anodized	38,95 €
975129	■	4m aluminium anodized	51,95 €
975122	■	1m black mat brushed	12,95 €
975123	■	2m black mat brushed	25,95 €
975124	□	1m white mat	12,95 €
975125	□	2m white mat	25,95 €
975126	■	1m aluminium brushed	12,95 €
975127	■	2m aluminium brushed	25,95 €

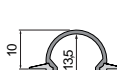

covers | PMMA [Polymethylmethacrylat]

	clear	matt	milky	
				
1m	983010	983012	983014	6,95 €
2m	983011	983013	983015	13,95 €
3m	983016	983017	983018	20,95 €
4m	983060	983061	983062	27,95 €
				
1m	983510	983512	983514	6,95 €
2m	983511	983513	983515	13,95 €
3m	983516	983517	983518	20,95 €
4m	983560	983561	983562	27,95 €
				
1m		984012	984014	6,95 €
2m		984013	984015	13,95 €
3m		984017	984018	20,95 €
4m		984010	984011	27,95 €
				
1m		984512	984514	6,95 €
2m		984513	984515	13,95 €
3m		984517	984518	20,95 €
4m		984510	984511	27,95 €
				
1m	985010			6,95 €
2m	985011			13,95 €
3m	985016			20,95 €

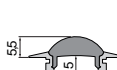
end caps set | 2 pieces 3,95 €

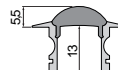
	white	grey	black		white	grey	black
							
	978090	978091	978092		978130	978131	978132
							
	978590	978591	978592		978630	978631	978632
							
	979040	979041	979042		979060	979061	979062
							
	979540	979541	979542		979560	979561	979562
							
	980040	980041	980042		980060	980061	980062

987004 fixation clamp 10 | set consisting of 2 pieces **2,95 €**



987080 universal mounting clip brackets [pivotable] set, 2 pieces | matching fixation clamp must be ordered separately **19,95 €**



930348 3M double-sided tape | 50 m x 15 mm **18,95 €**

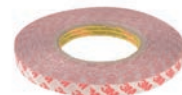

ET-01-12





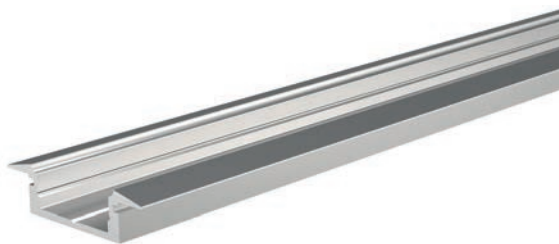
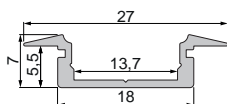



flat T-profile
for LED stripes up to 13,3 mm width

975040		1m aluminium anodized	12,95 €
975041		2m aluminium anodized	25,95 €
975042		1m black mat brushed	12,95 €
975043		2m black mat brushed	25,95 €
975044		1m white mat	12,95 €
975045		2m white mat	25,95 €
975046		1m aluminium brushed	12,95 €
975047		2m aluminium brushed	25,95 €





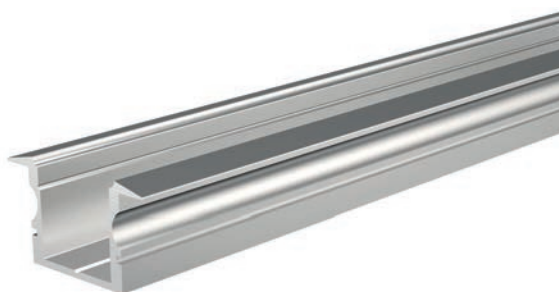
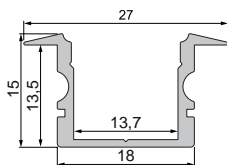

ET-02-12

high T-profile
for LED stripes up to 13,3 mm width

975140		1m aluminium anodized	14,95 €
975141		2m aluminium anodized	29,95 €
975148		3m aluminium anodized	44,95 €
975142		1m black mat brushed	14,95 €
975143		2m black mat brushed	29,95 €
975144		1m white mat	14,95 €
975145		2m white mat	29,95 €
975146		1m aluminium brushed	14,95 €
975147		2m aluminium brushed	29,95 €













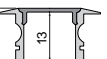

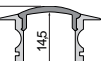

covers | PMMA [Polymethylmethacrylat]

	clear	matt	milky	
				
1m	983020	983022	983024	6,95 €
2m	983021	983023	983025	13,95 €
3m	983028	983027	983026	20,95 €
				
1m	983520	983522	983524	6,95 €
2m	983521	983523	983525	13,95 €
3m	983527	983526	983526	20,95 €
				
1m		984022	984024	6,95 €
2m		984023	984025	13,95 €
3m			984026	20,95 €
				
1m		984522	984524	6,95 €
2m		984523	984525	13,95 €
3m			984526	20,95 €

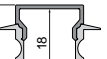
end caps set | 2 pieces **3,95 €**

-  white
-  grey
-  black

				978100	978140
				978101	978141
				978102	978142
				978600	978640
				978601	978641
				978602	978642
				979050	979070
				979051	979071
				979052	979072
				979550	979570
				979551	979571
				979552	979572

987006 fixation clamp 12 | set consisting of 2 pieces **2,95 €**



987080 universal mounting clip brackets [pivotable] set, 2 pieces | matching fixation clamp must be ordered separately **19,95 €**



930348 3M double-sided tape | 50 m x 15 mm **18,95 €**



ET-01-15

flat T-profile
for LED stripes up to 16,3 mm width

975060	■	1m aluminium anodized	12,95 €
975061	■	2m aluminium anodized	25,95 €
975062	■	1m black mat brushed	12,95 €
975063	■	2m black mat brushed	25,95 €
975064	□	1m white mat	12,95 €
975065	□	2m white mat	25,95 €
975066	■	1m aluminium brushed	12,95 €
975067	■	2m aluminium brushed	25,95 €

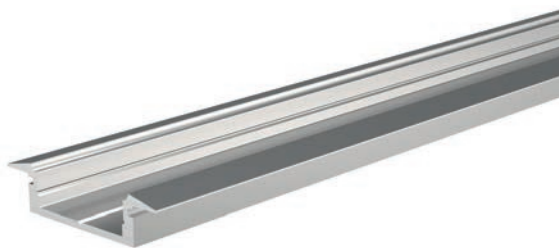
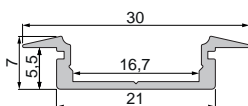

ET-02-15

high T-profile
for LED stripes up to 16,3 mm width

975160	■	1m aluminium anodized	14,95 €
975161	■	2m aluminium anodized	29,95 €
975168	■	3m aluminium anodized	44,95 €
975162	■	1m black mat brushed	14,95 €
975163	■	2m black mat brushed	29,95 €
975164	□	1m white mat	14,95 €
975165	□	2m white mat	29,95 €
975166	■	1m aluminium brushed	14,95 €
975167	■	2m aluminium brushed	29,95 €

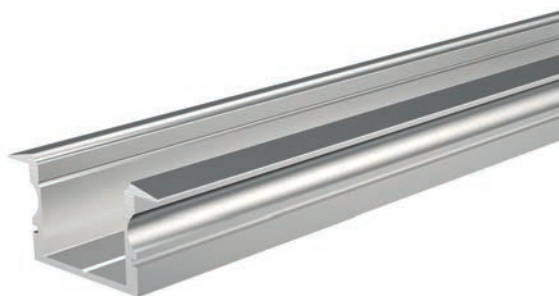
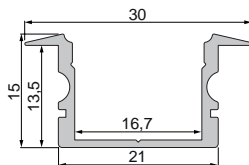

covers | PMMA [Polymethylmethacrylat]

clear matt milky



1m	983030	983032	983034	7,95 €
2m	983031	983033	983035	15,95 €
3m	983038	983037	983036	23,95 €



1m	983530	983532	983534	7,95 €
2m	983531	983533	983535	15,95 €
3m		983539	983536	23,95 €



1m		984032	984034	7,95 €
2m		984033	984035	15,95 €
3m			984036	23,95 €



1m		984532	984534	7,95 €
2m		984533	984535	15,95 €

end caps set | 2 pieces 3,95 €

- white
- grey
- black

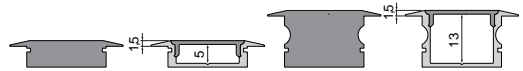

- white **978110**
- grey **978111**
- black **978112**

- white
- grey
- black

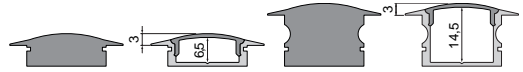

- white **978610**
- grey **978611**
- black **978612**

- white
- grey
- black

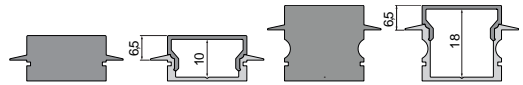

- white **979130**
- grey **979131**
- black **979132**

- white
- grey
- black

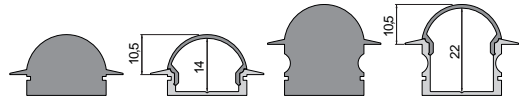

- white **979630**
- grey **979631**
- black **979632**

987008 fixation clamp 15 | set consisting of 2 pieces **2,95 €**



987080 universal mounting clip brackets [pivotable] set, 2 pieces | matching fixation clamp must be ordered separately **19,95 €**



930349 3M double-sided tape | 50 m x 20 mm **26,95 €**

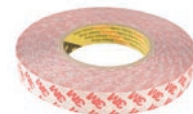





With the kind support of BEST/Bellemann Elektro Service Team GmbH, Rauenberg-Malschenberg



H- and slot profiles

Slot and H-profiles are offered with a comprehensive range of mounting accessories and are hard to beat in terms of versatility. The range of accessories includes cable suspensions, tension springs, sliding blocks and much more.

AH-01-20

H-profile

for LED stripes up to 21,3 mm width

- 970260  1m aluminium anodized
- 970261  2m aluminium anodized
- 970262  3m aluminium anodized

19,95 €

39,95 €

59,95 €

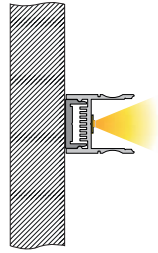
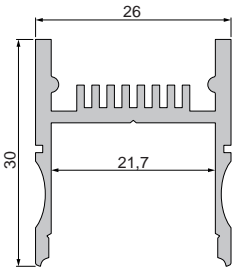
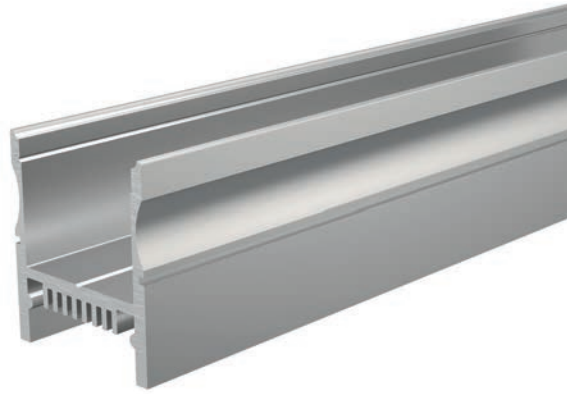

With the kind support of BEST Bellemann Elektro Service Team GmbH, Rauenberg-Malschenberg

covers | PMMA [Polymethylmethacrylat]

clear matt milky



1m	983040	983044	8,95 €
2m	983041	983045	17,95 €
3m		983046	26,95 €



1m		984044	8,95 €
2m		984045	17,95 €



1m		984544	8,95 €
2m		984545	17,95 €

end caps set | 2 pieces 3,95 €

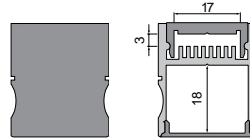

■ grey **978311**

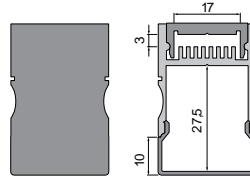

■ grey **979241**

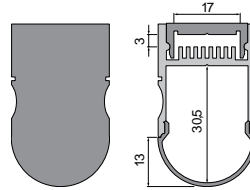

■ grey **979741**

MOUNTING / CARRIER PROFILE

for AH-01-20

970770 ■ 1m aluminium natural

9,95 €

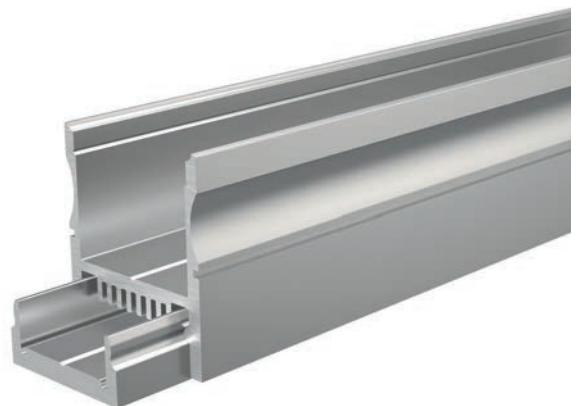
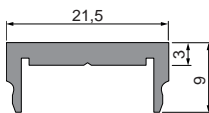

930111 screws set, incl. each 10 pieces
6 x 35 mm nylon dowels
4,5 x 45 mm stainless steel screw

6,95 €



AU-03-12

slot profile
for LED stripes up to 13,3 mm width

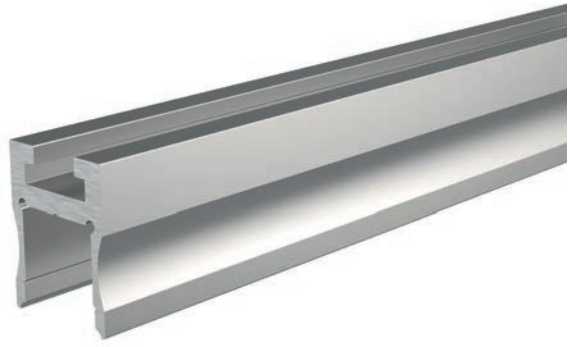

970230  1m aluminium anodized

15,95 €

970231  2m aluminium anodized

31,95 €

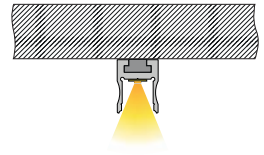
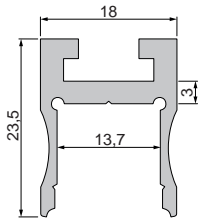



With the kind support of Friese Elektrotechnik, Ettenheim

covers | PMMA [Polymethylmethacrylat]

clear matt milky

				
1m	983020	983022	983024	6,95 €
2m	983021	983023	983025	13,95 €
3m	983028	983027	983026	20,95 €

				
1m	983520	983522	983524	6,95 €
2m	983521	983523	983525	13,95 €
3m	983527		983526	20,95 €

				
1m		984022	984024	6,95 €
2m		984023	984025	13,95 €
3m			984026	20,95 €

				
1m		984522	984524	6,95 €
2m		984523	984525	13,95 €
3m			984526	20,95 €

end caps set | 2 pieces **3,95 €**

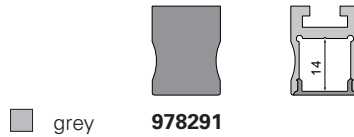

grey

978291

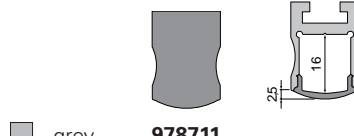

grey

978711

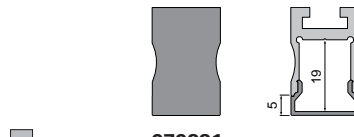

grey

979221

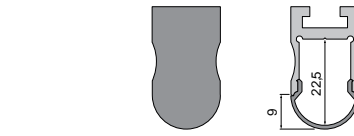

grey

979721

987060 wire suspension, pivotable, 2m | set | 2 pieces
For the installation of the wire suspension you need, depending on the profile, the universal sliding block 987020.

29,95 €





987020 universal sliding block/straight connector set | 2 pieces

6,95 €



ET-04-12

slot profile
for LED stripes up to 13,3 mm width

- | | | | |
|---------------|---|-----------------------|----------------|
| 975230 |  | 1m aluminium anodized | 16,95 € |
| 975231 |  | 2m aluminium anodized | 33,95 € |

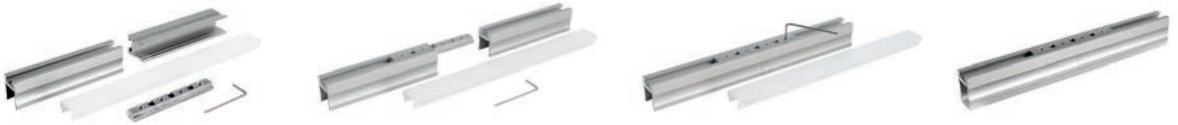
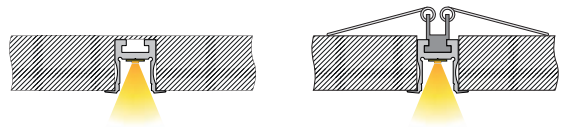
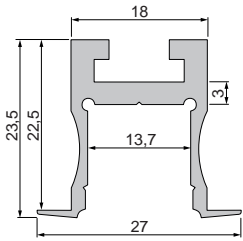

covers | PMMA [Polymethylmethacrylat]

clear matt milky



1m	983020	983022	983024	6,95 €
2m	983021	983023	983025	13,95 €
3m	983028	983027	983026	20,95 €



1m	983520	983522	983524	6,95 €
2m	983521	983523	983525	13,95 €
3m	983527		983526	20,95 €



1m		984022	984024	6,95 €
2m		984023	984025	13,95 €
3m			984026	20,95 €



1m		984522	984524	6,95 €
2m		984523	984525	13,95 €
3m			984526	20,95 €

end caps set | 2 pieces **3,95 €**

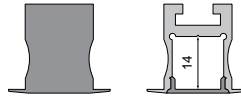

grey **978301**

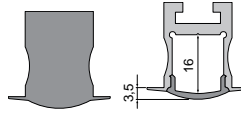

grey **978721**

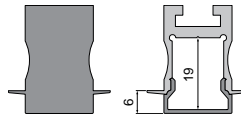

grey **979231**

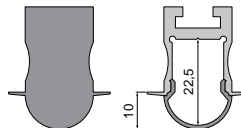

grey **979731**

end caps set | 2 pieces | aluminium **17,95 €**



silver **988021**

987040 sliding block with springsset
set | 2 pieces

6,95 €

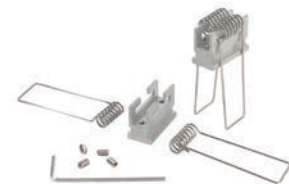

987020 universal sliding block/straight connector
set | 2 pieces





6,95 €



AU-10-12

slot profile
for LED stripes up to 13 mm width



970280		2m aluminium anodized	29,95 €
970281		3m aluminium anodized	44,95 €
970284		2m white mat	29,95 €
970285		3m white mat	44,95 €
970286		3m aluminium natural	44,95 €

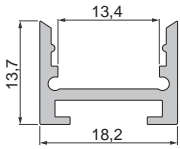

With the kind support of Friese Elektrotechnik, Ettenheim

covers | PMMA [Polymethylmethacrylat]

clear matt milky



2m	983090	19,95 €
3m	983091	29,95 €

end caps set | 2 pieces | aluminium **15,95 €**

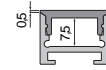

■ silver **980020**



■ silver **980021**



980020

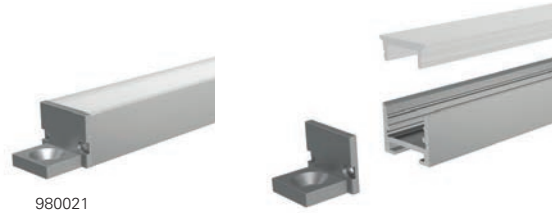

980021

980023 mounting clip | set | 2 pieces **3,95 €**



987025 sliding block | straight connector **7,95 €**



987026 sliding block | 120° corner connector **7,95 €**



987027 sliding block | 90° corner connector **7,95 €**





With the kind support of Albtherme Waldbronn / Ziegler Technics buer@ziegler-technics.de



step-, socket-, angle- and corner profiles

The perfect light is not always planned from the very start. With the mounting and corner profiles, you can also integrate linear light at a later stage.

AL-01-10

step profile
for LED stripes up to 11,3 mm width

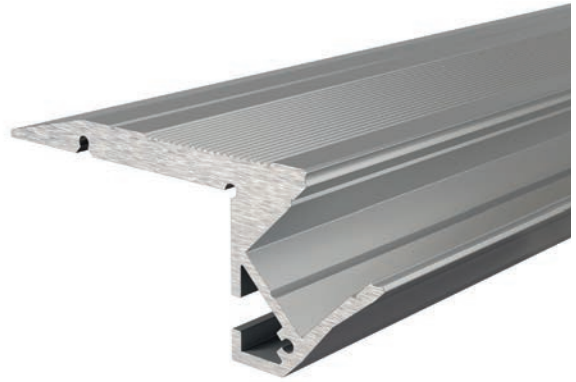

970500	■	1m aluminium anodized	24,95 €
970503	■	2m aluminium anodized	49,95 €
970502	■	3m aluminium anodized	74,95 €
970504	■	3m aluminium natural	74,95 €

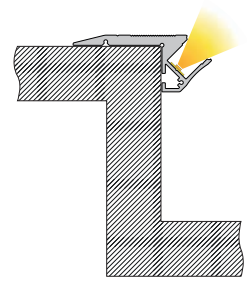
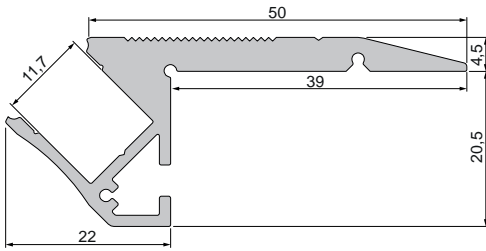

With the kind support of SH-Lichttechnik, Pflüngen und Beck's Reutlingen

covers | PMMA [Polymethylmethacrylat]

clear matt milky



1m	983010	983012	983014	6,95 €
2m	983011	983013	983015	13,95 €
3m	983016	983017	983018	20,95 €
4m	983060	983061	983062	27,95 €



walkable | PC [polycarbonate]

1m		983080	8,95 €
2m		983081	17,95 €
3m		983082	26,95 €

end caps set | right + left 3,95 €

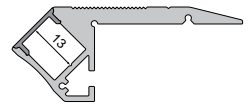

grey

978191

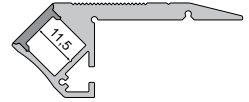

930111 screws set, incl. each 10 pieces
6 x 35 mm nylon dowels
4,5 x 45 mm stainless steel screw





6,95 €



AL-02-10

step profile
for LED stripes up to 11,3 mm width



970520		1m aluminium anodized	24,95 €
970523		2m aluminium anodized	49,95 €
970522		3m aluminium anodized	74,95 €
970524		3m aluminium natural	74,95 €

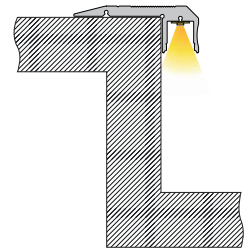
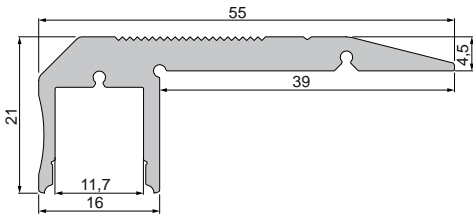

With the kind support of Elektro Grün, Neustadt an der Weinstraße

covers | PMMA [Polymethylmethacrylat]

clear matt milky



1m	983010	983012	983014	6,95 €
2m	983011	983013	983015	13,95 €
3m	983016	983017	983018	20,95 €
4m	983060	983061	983062	27,95 €

end caps set | right + left **3,95 €**

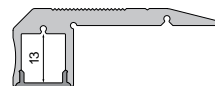

 grey

978201



930111 screws set, incl. each 10 pieces
6 x 35 mm nylon dowels
4,5 x 45 mm stainless steel screw

6,95 €



AM-02-10

socket profile
for LED stripes up to 11,3 mm width

970602		2m aluminium anodized	66,95 €
970600		3m aluminium anodized	99,95 €
970601		3m black mat brushed	99,95 €

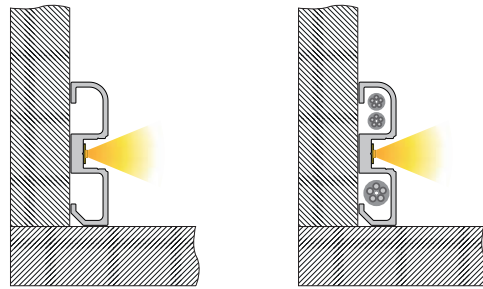
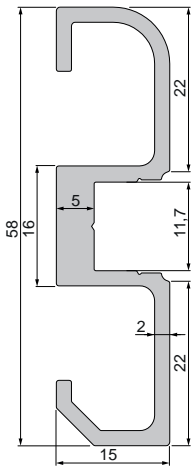

covers | PMMA [Polymethylmethacrylat]

clear matt milky



1m	983010	983012	983014	6,95 €
2m	983011	983013	983015	13,95 €
3m	983016	983017	983018	20,95 €
4m	983060	983061	983062	27,95 €



1m	983510	983512	983514	6,95 €
2m	983511	983513	983515	13,95 €
3m	983516	983517	983518	20,95 €
4m	983560	983561	983562	27,95 €



1m		984012	984014	6,95 €
2m		984013	984015	13,95 €
3m		984017	984018	20,95 €
4m		984010	984011	27,95 €

end caps set | right + left **3,95 €**

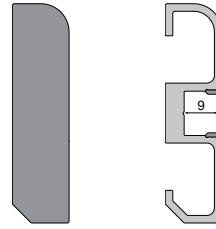

■ grey **978241**
 ■ black **978242**

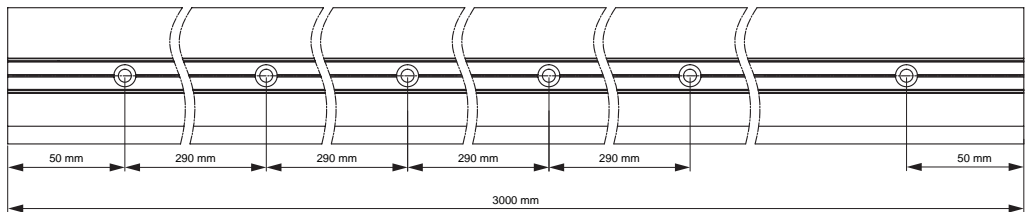
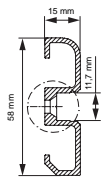
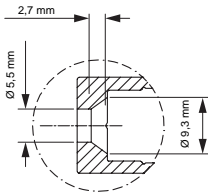

930111 screws set, incl. each 10 pieces
 6 x 35 mm nylon dowels
 4,5 x 45 mm stainless steel screw

6,95 €



AV-01-20

angle profile 45°
for LED stripes up to 22 mm width

970460  2m aluminium anodized

29,95 €

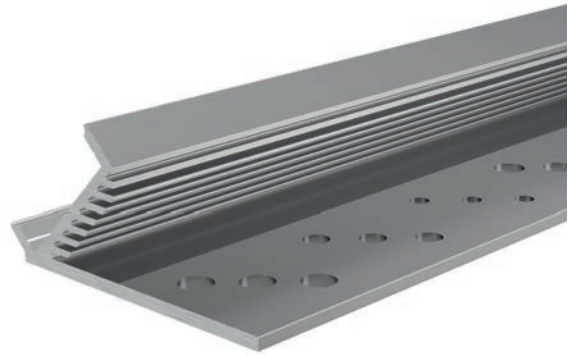
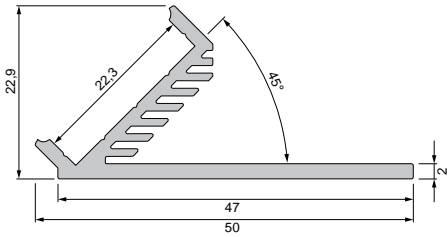

pre-punched drill / screw holes [Ø 3; 4 und 5 mm]
for easier mounting

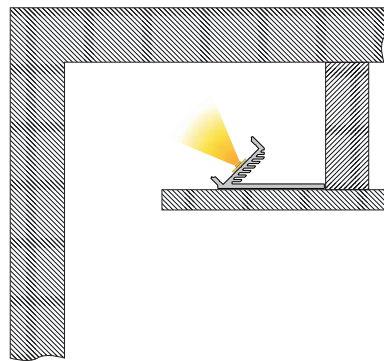
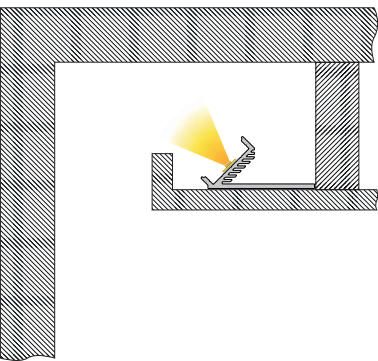
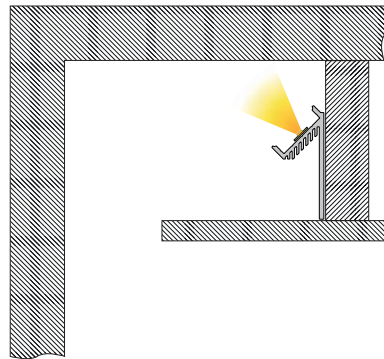
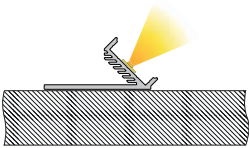

covers | PMMA [Polymethylmethacrylat]

clear matt milky



1m	983040	983044	8,95 €
2m	983041	983045	17,95 €
3m		983046	26,95 €

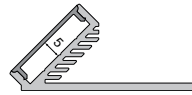

1m		984044	8,95 €
2m		984045	17,95 €

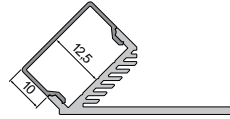

1m		984544	8,95 €
2m		984545	17,95 €

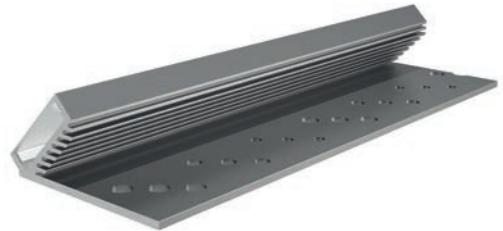
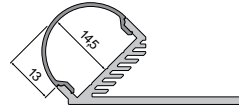

930105 310ml cartridge, white glue+sealing power

29,95 €



930350 3M double-sided tape | 50 m x 25 mm

32,95 €

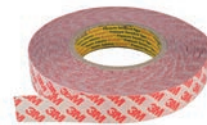

930111 screws set, incl. each 10 pieces
6 x 35 mm nylon dowels
4,5 x 45 mm stainless steel screw

6,95 €



AV-02-20

angle profile 135°

for LED stripes up to 22 / 17 mm width

970470



2m aluminium anodized

29,95 €

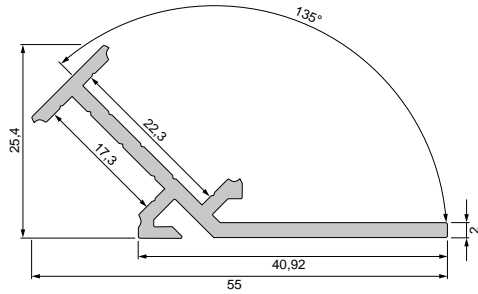

pre-punched drill / screw holes [Ø 3; 4 und 5 mm]
for easier mounting

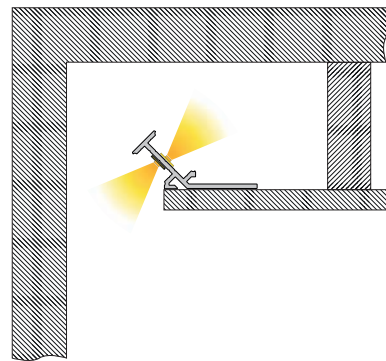
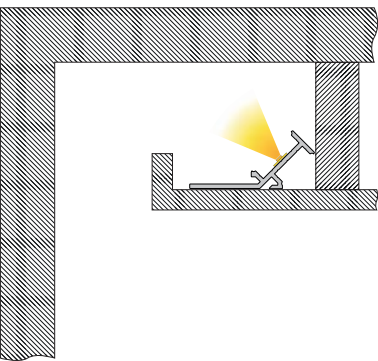
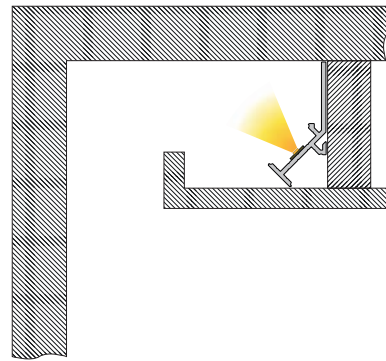
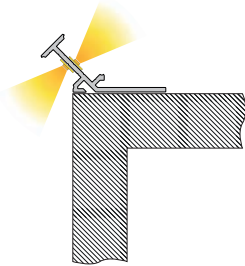
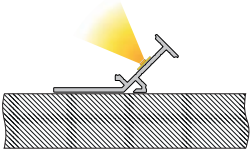

20er covers | PMMA [Polymethylmethacrylat]

clear matt milky

				
1m	983040	983044	8,95 €	
2m	983041	983045	17,95 €	
3m		983046	26,95 €	

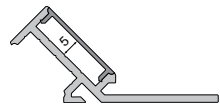

				
1m		984044	8,95 €	
2m		984045	17,95 €	

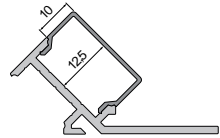

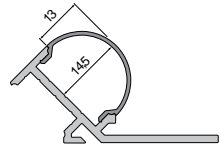

				
1m		984544	8,95 €	
2m		984545	17,95 €	



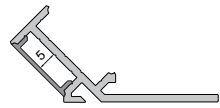

15er covers | PMMA [Polymethylmethacrylat]

				
1m	983030	983032	983034	7,95 €
2m	983031	983033	983035	15,95 €
3m	983038	983037	983036	23,95 €

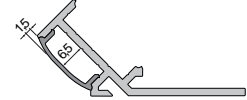

				
1m	983530	983532	983534	7,95 €
2m	983531	983533	983535	15,95 €
3m		983539	983536	23,95 €



				
1m		984032	984034	7,95 €
2m		984033	984035	15,95 €
3m			984036	23,95 €

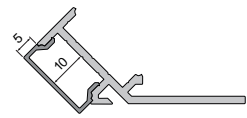

				
1m		984532	984534	7,95 €
2m		984533	984535	15,95 €

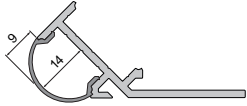

930105 310ml cartridge, white glue+sealing power

29,95 €



930350 3M double-sided tape | 50 m x 25 mm

32,95 €

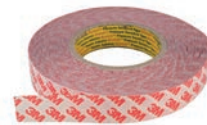

930111 screws set, incl. each 10 pieces
6 x 35 mm nylon dowels
4,5 x 45 mm stainless steel screw

6,95 €



AV-03-12

corner profile

for LED stripes up to 13,3 mm width

970432	■	1m aluminium anodized	15,95 €
970430	■	1,25m aluminium anodized	19,95 €
970433	■	2m aluminium anodized	31,95 €
970431	■	2,5m aluminium anodized	39,95 €
970434	■	3m aluminium anodized	47,95 €
970436	□	1m white mat	15,95 €
970437	□	2m white mat	31,95 €
970438	□	3m white mat	47,95 €

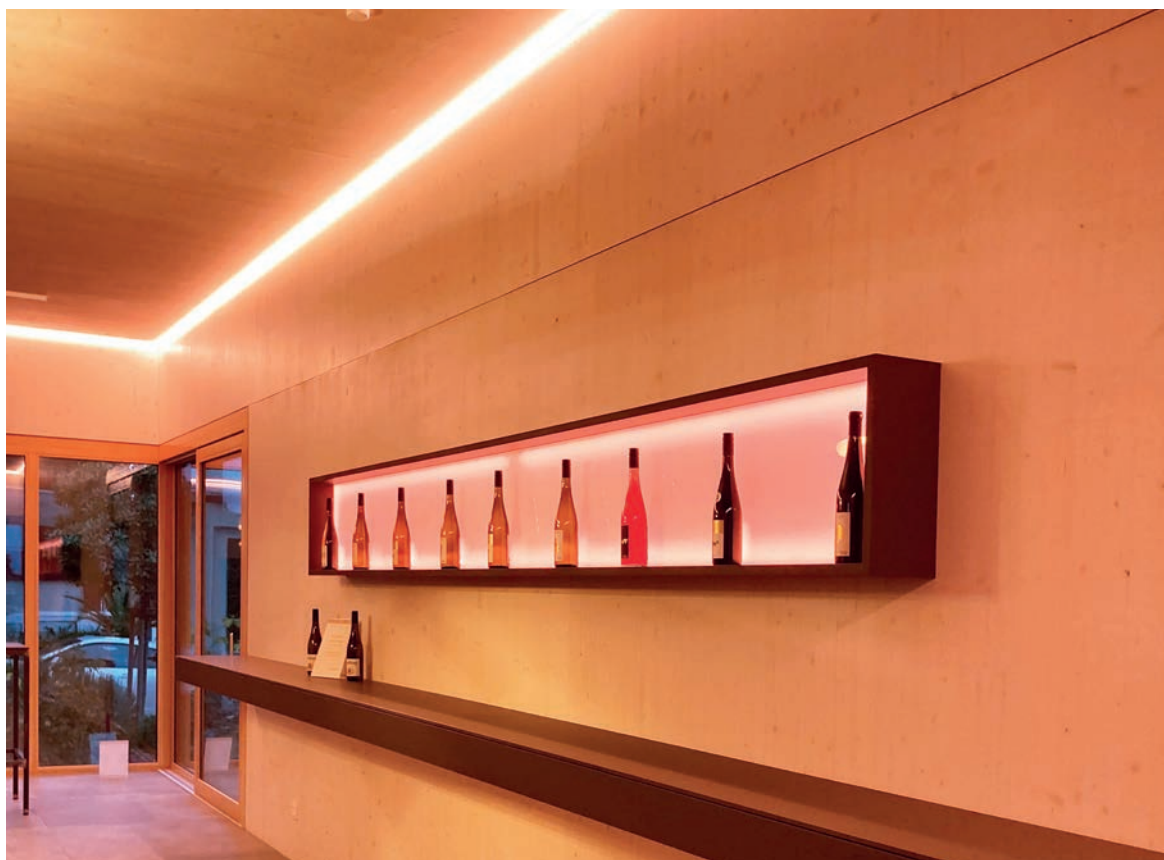
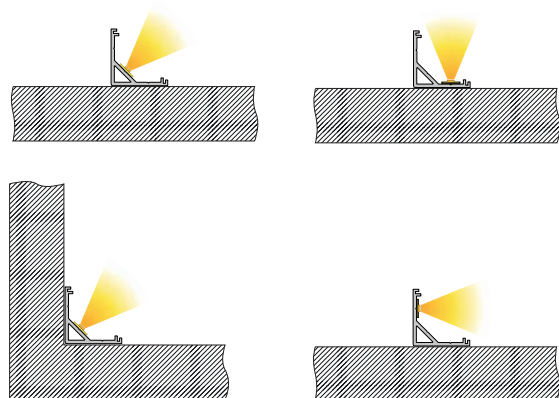
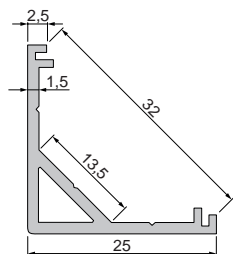

With the kind support of Elektro Grün, Neustadt an der Weinstraße

covers | PC [polycarbonate]

clear matt milky



2m
3m

984565 17,95 €
984568 26,95 €

end caps set | 2 pieces **3,95 €**

 grey

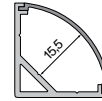
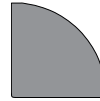

979751

930105 310ml cartridge, white glue+sealing power

29,95 €



930348 3M double-sided tape | 50 m x 15 mm

18,95 €

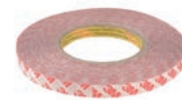

930111 screws set, incl. each 10 pieces
6 x 35 mm nylon dowels
4,5 x 45 mm stainless steel screw

6,95 €



AV-05-12

corner profile

for LED stripes up to 12,5 mm width



970550  2m aluminium anodized

33,95 €

970551  3m aluminium anodized

49,95 €

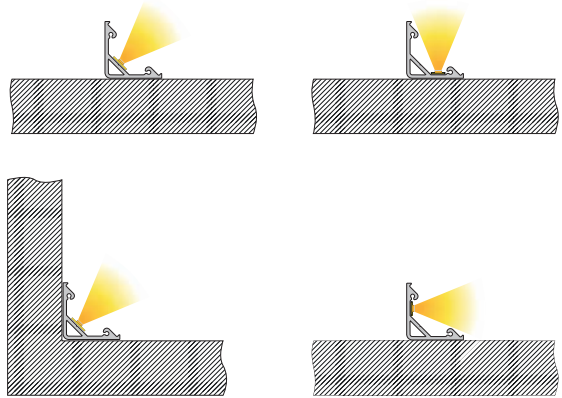
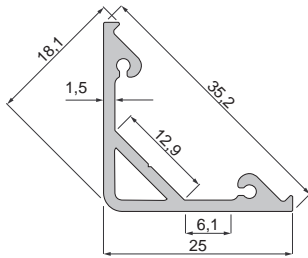

With the kind support of Alitherme Waldbrunn / Ziegler Technics buero@ziegler-technics.de

covers | PC [polycarbonate]

clear matt milky



2m
3m

983100 **19,95 €**
983101 **29,95 €**



2m
3m

984570 **19,95 €**
984571 **29,95 €**



2m
3m

985570 **19,95 €**
985571 **29,95 €**

end caps set | 2 pieces | aluminium **17,95 €**

■ silver



978370

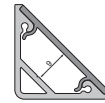

■ silver

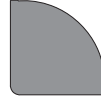

979760



■ silver



980550

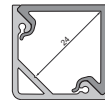

930105 310ml cartridge, white glue+sealing power

29,95 €



930350 3M double-sided tape | 50 m x 25 mm

32,95 €

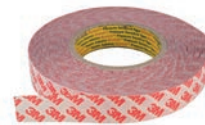

930111 screws set, incl. each 10 pieces
6 x 35 mm nylon dowels
4,5 x 45 mm stainless steel screw

6,95 €



AV-05-15

corner profile
for LED stripes up to 15,4 mm width



970560  2m aluminium anodized

41,95 €

970561  3m aluminium anodized

62,95 €

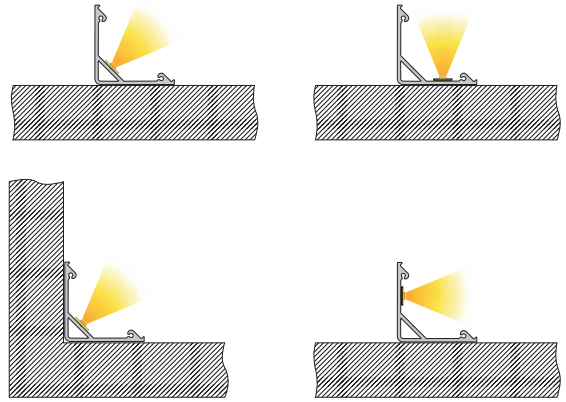
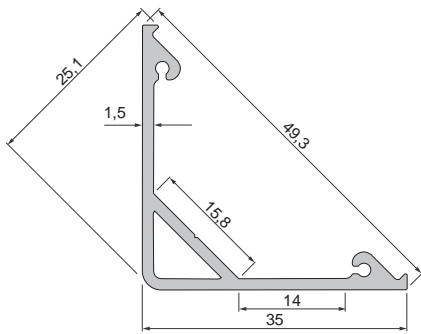

covers | PC [polycarbonate]

clear matt milky



2m
3m

983110 **24,95 €**
983111 **37,95 €**



2m
3m

984580 **24,95 €**
984581 **37,95 €**

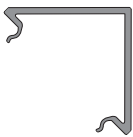

2m
3m

985580 **24,95 €**
985581 **37,95 €**

end caps set | 2 pieces | aluminium **17,95 €**

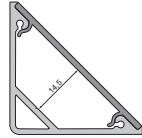
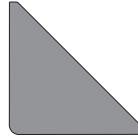

■ silver

978380

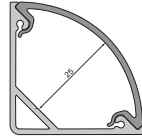
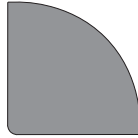

■ silver

979770

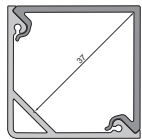

■ silver

980560

930105 310ml cartridge, white glue+sealing power

29,95 €



930350 3M double-sided tape | 50 m x 25 mm

32,95 €

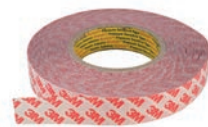

930111 screws set, incl. each 10 pieces
6 x 35 mm nylon dowels
4,5 x 45 mm stainless steel screw



6,95 €



AV-05-25

corner profile
for LED stripes up to 25,5 mm width



- | | | | |
|---------------|---|-----------------------|----------------|
| 970570 |  | 2m aluminium anodized | 55,95 € |
| 970571 |  | 3m aluminium anodized | 83,95 € |

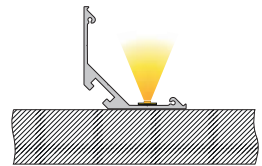
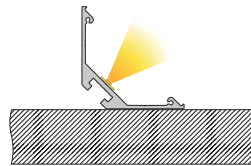
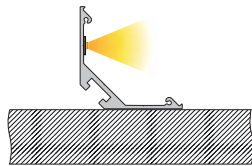
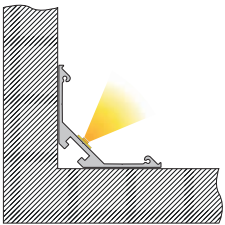
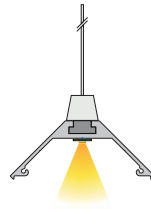
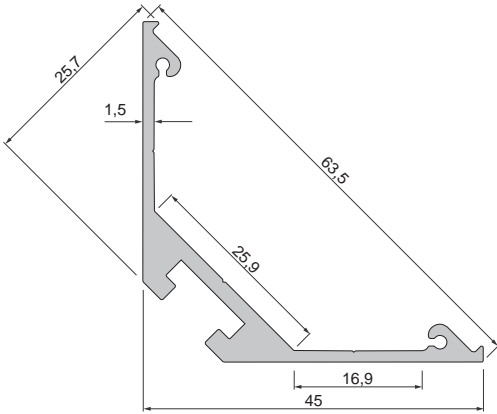

covers | PC [polycarbonate]

clear matt milky



2m **983120** **29,95 €**
 3m **983121** **44,95 €**

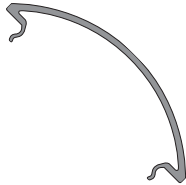

2m **984590** **29,95 €**
 3m **984591** **44,95 €**

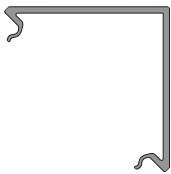

2m **985590** **29,95 €**
 3m **985591** **44,95 €**

end caps set | 2 pieces | aluminium **17,95 €**

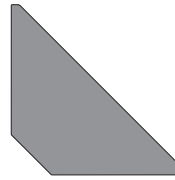

■ silver **978390**

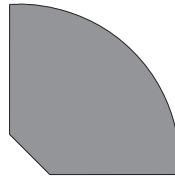
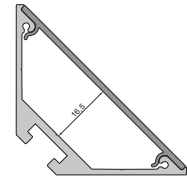

■ silver **979780**

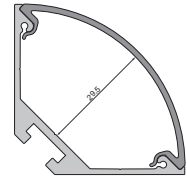

■ silver **980570**

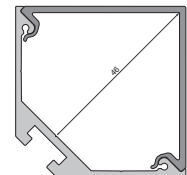

987060 wire suspension, pivotable, 2m | set | 2 pieces **29,95 €**
 For the installation of the wire suspension you need, depending on the profile, the universal sliding block 987020.



987020 universal sliding block/straight connector set | 2 pieces **6,95 €**



930105 310ml cartridge, white glue+sealing power **29,95 €**



930350 3M double-sided tape | 50 m x 25 mm **32,95 €**

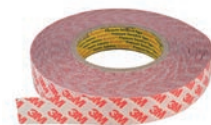









930111 screws set, incl. each 10 pieces
 6 x 35 mm nylon dowels
 4,5 x 45 mm stainless steel screw **6,95 €**



AM-01-10

mounting-/substructure-profile
for LED stripes up to 11,3 mm width



970300		1m aluminium anodized	15,95 €
970301		2m aluminium anodized	31,95 €
970308		3m aluminium anodized	47,95 €
970302		1m black mat brushed	15,95 €
970303		2m black mat brushed	31,95 €
970304		1m white mat	15,95 €
970305		2m white mat	31,95 €
970306		1m aluminium brushed	15,95 €
970307		2m aluminium brushed	31,95 €

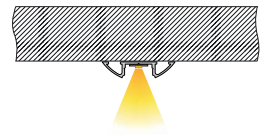
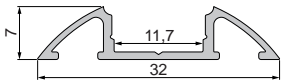

With the kind support of BEST Bellemann Elektro Service Team GmbH, Rauenberg-Malschenberg

covers | PC [polycarbonate]

clear matt milky



1m	983010	983012	983014	6,95 €
2m	983011	983013	983015	13,95 €
3m	983016	983017	983018	20,95 €
4m	983060	983061	983062	27,95 €



1m	983510	983512	983514	6,95 €
2m	983511	983513	983515	13,95 €
3m	983516	983517	983518	20,95 €
4m	983560	983561	983562	27,95 €

end caps set | 2 pieces **3,95 €**

- white **978700**
- grey **978701**
- black **978702**



- grey **980541**

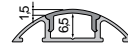

930105 310ml cartridge, white glue+sealing power **29,95 €**



930348 3M double-sided tape | 50 m x 15 mm **18,95 €**

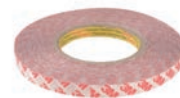

930111 screws set, incl. each 10 pieces
6 x 35 mm nylon dowels
4,5 x 45 mm stainless steel screw **6,95 €**





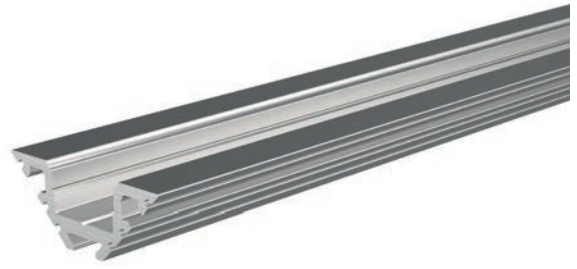

AV-01-10

corner profile

for LED stripes up to 11,3 mm width



970401		2m aluminium anodized	29,95 €
970404		3m aluminium anodized	44,95 €
970403		2m white mat	29,95 €
970405		3m aluminium natural	44,95 €



Foto: Daniel Vießer - Architekturfotografie, Karlsruhe

covers | PMMA [Polymethylmethacrylat]

clear matt milky

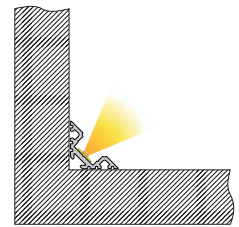
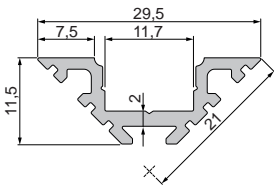

1m	983010	983012	983014	6,95 €
2m	983011	983013	983015	13,95 €
3m	983016	983017	983018	20,95 €
4m	983060	983061	983062	27,95 €



1m	983510	983512	983514	6,95 €
2m	983511	983513	983515	13,95 €
3m	983516	983517	983518	20,95 €
4m	983560	983561	983562	27,95 €



1m		984012	984014	6,95 €
2m		984013	984015	13,95 €
3m		984017	984018	20,95 €
4m		984010	984011	27,95 €



1m		984512	984514	6,95 €
2m		984513	984515	13,95 €
3m		984517	984518	20,95 €
4m		984510	984511	27,95 €



1m	985010			6,95 €
2m	985011			13,95 €
3m	985016			20,95 €

end caps set | 2 pieces **3,95 €**



□ white **978170**
 ■ grey **978171**

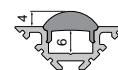
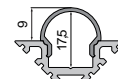
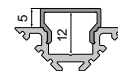
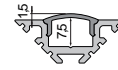

930105 310ml cartridge, white glue+sealing power

29,95 €



930348 3M double-sided tape | 50 m x 15 mm

18,95 €

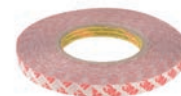

930111 screws set, incl. each 10 pieces
 6 x 35 mm nylon dowels
 4,5 x 45 mm stainless steel screw

6,95 €





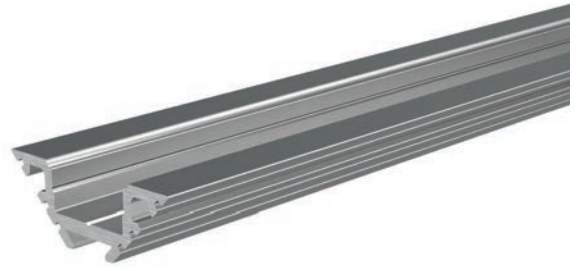

AV-04-12

corner profile

for LED stripes up to 13,3 mm width



970410		1m aluminium anodized	16,95 €
970411		2m aluminium anodized	33,95 €
970414		3m aluminium anodized	50,95 €
970413		2m white mat	33,95 €

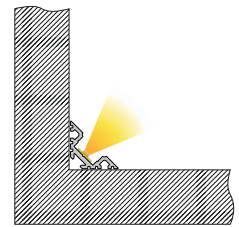
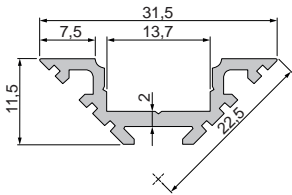

With the kind support of EA Listen / Euphonic Architect www.ea-listen.com

covers | PMMA [Polymethylmethacrylat]

clear matt milky



1m	983020	983022	983024	6,95 €
2m	983021	983023	983025	13,95 €
3m	983028	983027	983026	20,95 €



1m	983520	983522	983524	6,95 €
2m	983521	983523	983525	13,95 €
3m	983527		983526	20,95 €



1m		984022	984024	6,95 €
2m		984023	984025	13,95 €
3m			984026	20,95 €



1m		984522	984524	6,95 €
2m		984523	984525	13,95 €
3m			984526	20,95 €

end caps set | 2 pieces 3,95 €

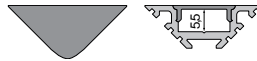

- white **978330**
- grey **978331**

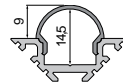
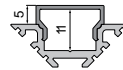
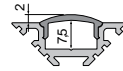

930105 310ml cartridge, white glue+sealing power **29,95 €**



930348 3M double-sided tape | 50 m x 15 mm **18,95 €**

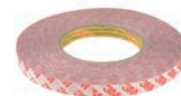

930111 screws set, incl. each 10 pieces
6 x 35 mm nylon dowels
4,5 x 45 mm stainless steel screw **6,95 €**





EV-04-12

corner profile

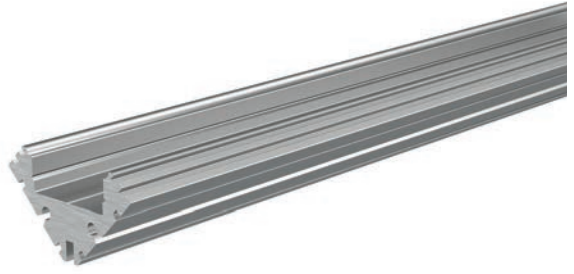
for LED stripes up to 13,3 mm width



975411		2m aluminium anodized	33,95 €
975412		3m aluminium anodized	50,95 €

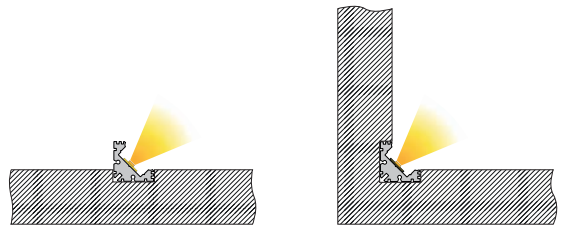
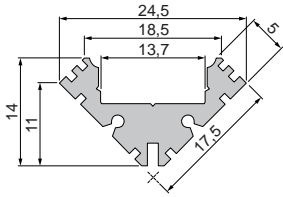

With the kind support of Elektro Grün, Neustadt an der Weinstraße

covers | PMMA [Polymethylmethacrylat]

clear matt milky



1m	983020	983022	983024	6,95 €
2m	983021	983023	983025	13,95 €
3m	983028	983027	983026	20,95 €



1m	983520	983522	983524	6,95 €
2m	983521	983523	983525	13,95 €
3m	983527		983526	20,95 €



1m		984022	984024	6,95 €
2m		984023	984025	13,95 €
3m			984026	20,95 €



1m		984522	984524	6,95 €
2m		984523	984525	13,95 €
3m			984526	20,95 €

end caps set | 2 pieces **3,95 €**

 grey

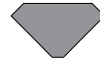

978341

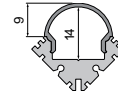
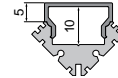
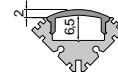
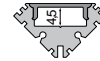

987006 fixation clamp 12 | set consisting of 2 pieces **2,95 €**



987080 universal mounting clip brackets [pivotable] set, 2 pieces | matching fixation clamp must be ordered separately **19,95 €**



930105 310ml cartridge, white glue+sealing power **29,95 €**



930111 screws set, incl. each 10 pieces
6 x 35 mm nylon dowels
4,5 x 45 mm stainless steel screw **6,95 €**





With the kind support of BEST Bellemann Elektro Service Team GmbH, Rauenberg-Malschenberg









dry construction profiles

Our dry construction profiles offer you full creative freedom. Redefine linear light – whether as a primary light or for accent lighting.

EL-02-12

dry construction profile | wall cove
for LED stripes up to 14 mm width



975490		1m aluminium anodized	33,95 €
975491		2m aluminium anodized	66,95 €
975496		3m aluminium anodized	99,95 €
975494		1m white mat	33,95 €
975495		2m white mat	66,95 €
975498		3m aluminium natural	99,95 €

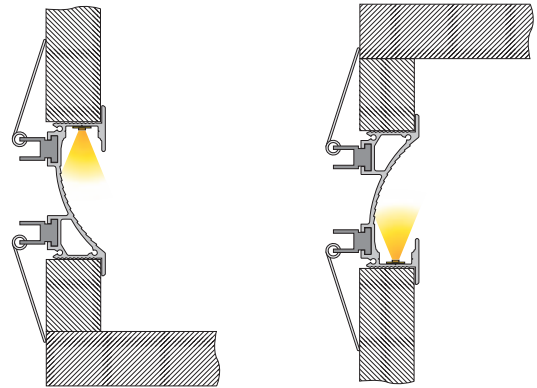
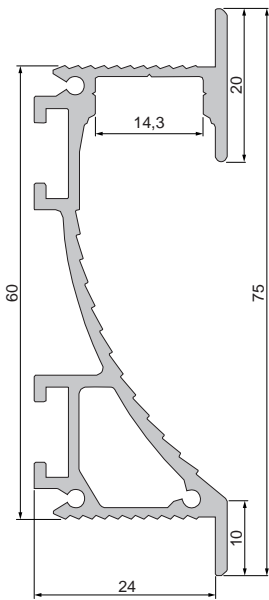

covers | PMMA [Polymethylmethacrylat]

clear matt milky



1m	983020	983022	983024	6,95 €
2m	983021	983023	983025	13,95 €
3m	983028	983027	983026	20,95 €

end caps set | right + left **3,95 €**

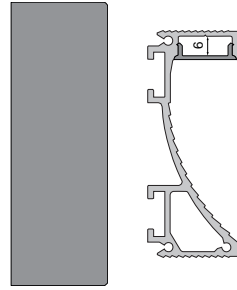

- white **978250**
- grey **978251**

end caps set | right + left | aluminium **29,95 €**



- silver **978252**

930105 310ml cartridge, white glue+sealing power **29,95 €**



987040 sliding block with springsset set | 2 pieces **6,95 €**

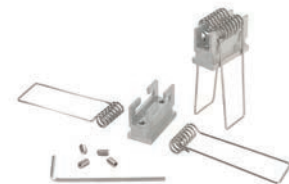

987020 universal sliding block/straight connector set | 2 pieces **6,95 €**



AV-02-10

dry construction profile | outside corner
for LED stripes up to 11,3 mm width

970450	■	2,5m aluminium anodized	41,95 €
970455	■	3m aluminium anodized	49,95 €
970452	□	2,5m white mat	41,95 €

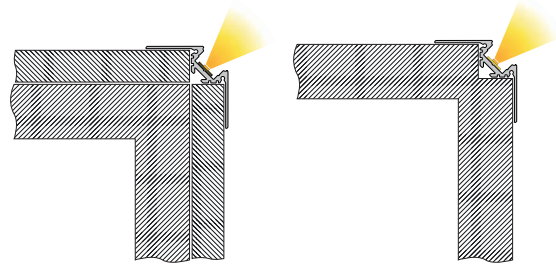
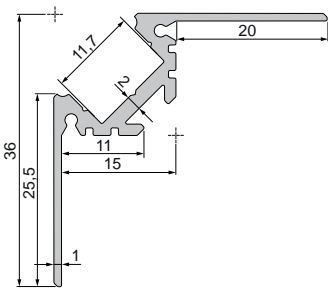

covers | PMMA [Polymethylmethacrylat]

clear matt milky



1m	983010	983012	983014	6,95 €
2m	983011	983013	983015	13,95 €
3m	983016	983017	983018	20,95 €
4m	983060	983061	983062	27,95 €



1m		985514	6,95 €
2m		985515	13,95 €
3m		985518	20,95 €

end caps set | 2 pieces **3,95 €**



□ white **978180**
 ■ grey **978181**

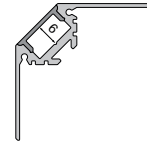

□ white **980520**
 ■ grey **980521**

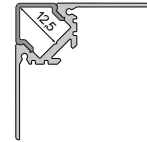

930105 310ml cartridge, white glue+sealing power **29,95 €**



930348 3M double-sided tape | 50 m x 15 mm **18,95 €**

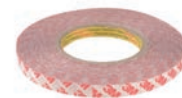



930111 screws set, incl. each 10 pieces
 6 x 35 mm nylon dowels
 4,5 x 45 mm stainless steel screw **6,95 €**

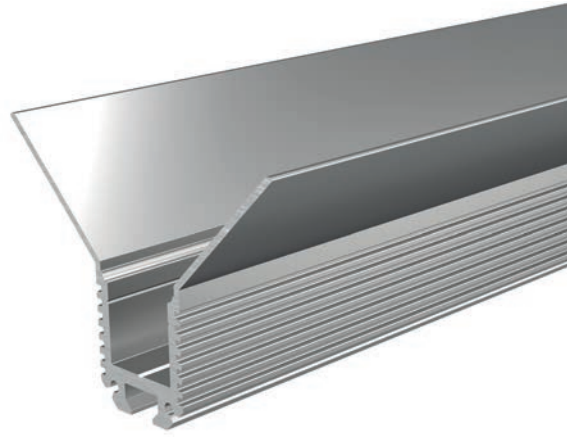

EV-03-10

dry construction profile | inside corner
for LED stripes up to 12 mm width



975460  2,5m aluminium anodized

41,95 €

975462  2,5m white mat

41,95 €

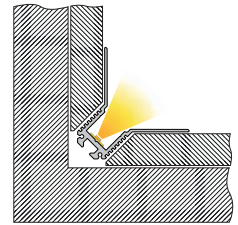
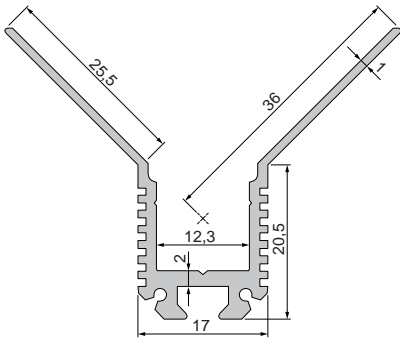

covers | PMMA [Polymethylmethacrylat]

clear matt milky



1m	983010	983012	983014	6,95 €
2m	983011	983013	983015	13,95 €
3m	983016	983017	983018	20,95 €
4m	983060	983061	983062	27,95 €



1m		985554	6,95 €
2m		985555	13,95 €
3m		985558	20,95 €

end caps set | 2 pieces **3,95 €**



white **978280**
 grey **978281**

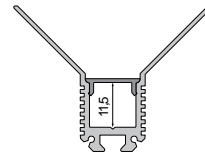

white **980530**
 grey **980531**

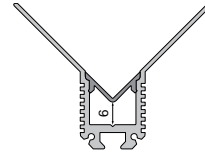

930105 310ml cartridge, white glue+sealing power **29,95 €**



930349 3M double-sided tape | 50 m x 20 mm **26,95 €**



930111 screws set, incl. each 10 pieces
 6 x 35 mm nylon dowels
 4,5 x 45 mm stainless steel screw **6,95 €**



ET-03-10

dry construction profile | wall | ceiling
for LED stripes up to 12 mm width



975470	<input checked="" type="checkbox"/>	1,25m aluminium anodized	24,95 €
975471	<input checked="" type="checkbox"/>	2,5m aluminium anodized	49,95 €
975476	<input checked="" type="checkbox"/>	3m aluminium anodized	59,95 €
975474	<input type="checkbox"/>	1,25m white mat	24,95 €
975475	<input type="checkbox"/>	2,5m white mat	49,95 €

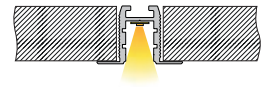
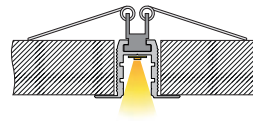
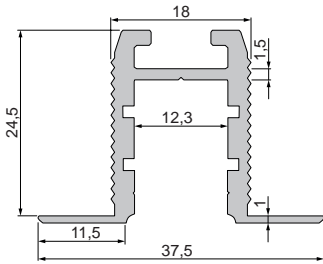



With the kind support of Friese Elektrotechnik, Ettenheim

covers | PMMA [Polymethylmethacrylat]



clear matt milky



				
1m	983010	983012	983014	6,95 €
2m	983011	983013	983015	13,95 €
3m	983016	983017	983018	20,95 €
4m	983060	983061	983062	27,95 €

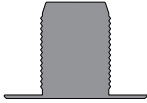
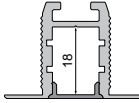

				
1m	984012	984014	984014	6,95 €
2m	984013	984015	984015	13,95 €
3m	984017	984018	984018	20,95 €
4m	984010	984011	984011	27,95 €

				
1m	984512	984514	984514	6,95 €
2m	984513	984515	984515	13,95 €
3m	984517	984518	984518	20,95 €
4m	984510	984511	984511	27,95 €

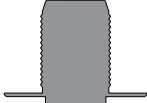
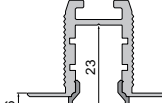
end caps set | 2 pieces 3,95 €

		
	white	978260
	grey	978261

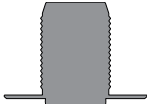
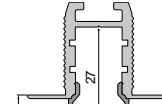
		
	white	979200
	grey	979201

		
	white	979700
	grey	979701

970762 carrier profile for LED stripes
aluminium natural | 1,25m

5,95 €

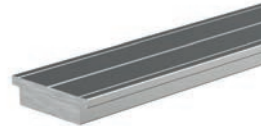
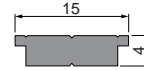

930105 310ml cartridge, white glue+sealing power

29,95 €



987040 sliding block with springs set
set | 2 pieces

6,95 €

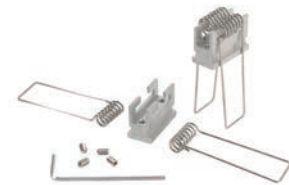





987020 universal sliding block/straight connector
set | 2 pieces

6,95 €



EL-03-10

dry construction profile | ceiling cove
for LED stripes up to 12 mm width

975483	 2m aluminium anodized	49,95 €
975481	 2,5m aluminium anodized	62,95 €
975486	 3m aluminium anodized	74,95 €
975485	 2,5m white mat	62,95 €

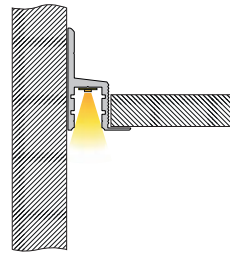
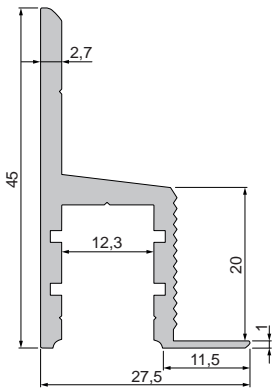

covers | PMMA [Polymethylmethacrylat]

clear matt milky



1m	983010	983012	983014	6,95 €
2m	983011	983013	983015	13,95 €
3m	983016	983017	983018	20,95 €
4m	983060	983061	983062	27,95 €



1m	984012	984014	6,95 €
2m	984013	984015	13,95 €
3m	984017	984018	20,95 €
4m	984010	984011	27,95 €



1m	984512	984514	6,95 €
2m	984513	984515	13,95 €
3m	984517	984518	20,95 €
4m	984510	984511	27,95 €

end caps set | right + left **3,95 €**

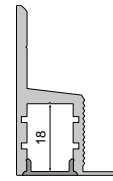
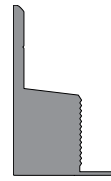

□ white **978270**
 ■ grey **978271**

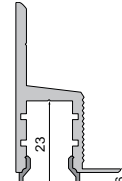
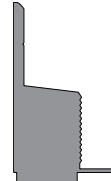

□ white **979210**
 ■ grey **979211**

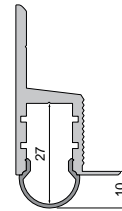
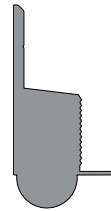

□ white **979710**
 ■ grey **979711**

970762 carrier profile for LED stripes
 aluminium natural | 1,25m

5,95 €

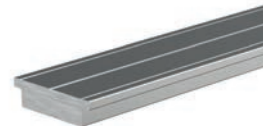
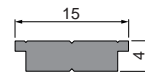

930111 screws set, incl. each 10 pieces
 6 x 35 mm nylon dowels
 4,5 x 45 mm stainless steel screw

6,95 €



EU-01-36

dry construction profile | wall | ceiling
for LED stripes up to 36 mm width

975501  3m aluminium natural

99,95 €

- optimised and designed for the built-in of 12.5 mm gypsum plasterboards
- easy to plaster thanks to optional inlay for protection
- increased passive cooling of the stripes due to cooling fins
- optimal for homogeneous bright light lines

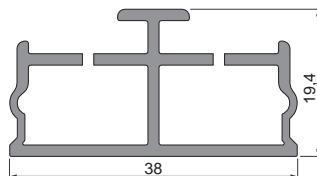
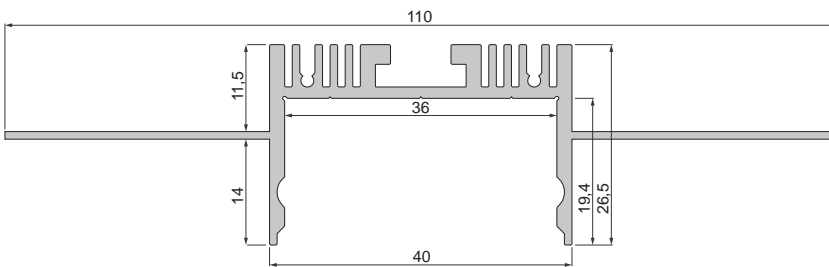
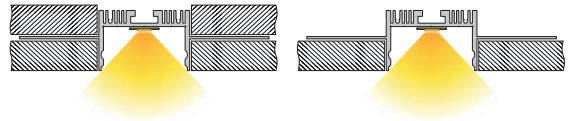
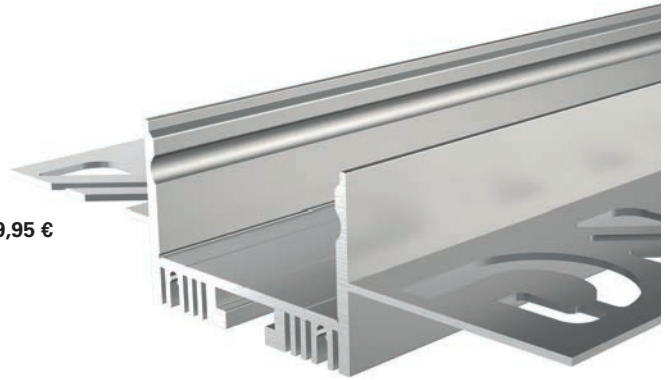

covers | PMMA [Polymethylmethacrylat]

clear matt milky



3m

985601 34,95 €

end caps set | 2 pieces | aluminium **17,95 €**



■ silver

978175

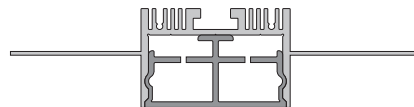
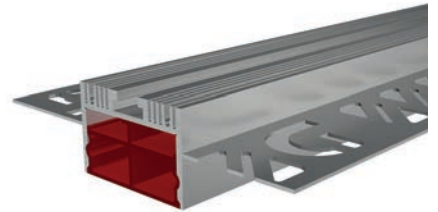
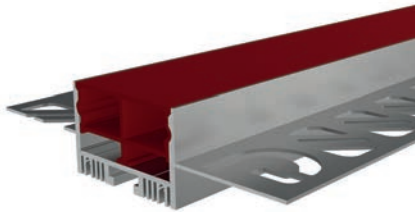
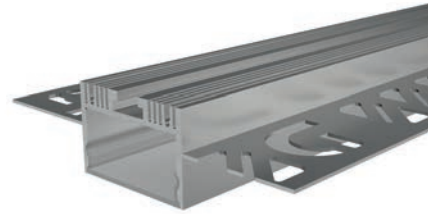
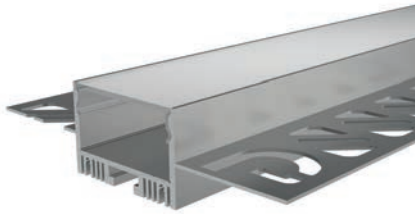
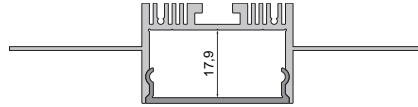

985605 inlay / dummy [reusable]
Plastic | red | 3m

24,95 €



With the kind support of BEST Bellemann Elektro Service Team GmbH, Rauenberg-Malschenberg





tile profiles

Tile profiles play to every corner and closing area. Do away with conventional tile end profiles and set a new standard with linear light.

EL-01-08

tile profile | built-in | closing
for LED stripes up to 9,3 mm width



- 975331  2,5m aluminium anodized **43,95 €**
- 975334  3m aluminium anodized **52,95 €**

tile thickness designed up to max. 9 mm

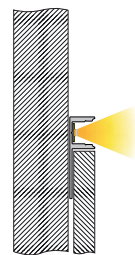
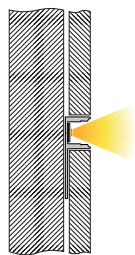
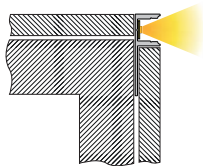
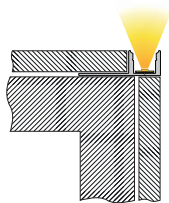
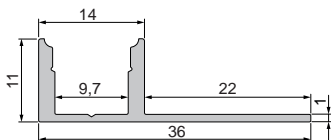

SOFT GROUTING

optionally available as customised special design
more information on page 819

tile profile	light colour	item	rm. price
EL-01-08	2700K	840362	274,95 €
EL-01-08	RGB	840366	274,95 €

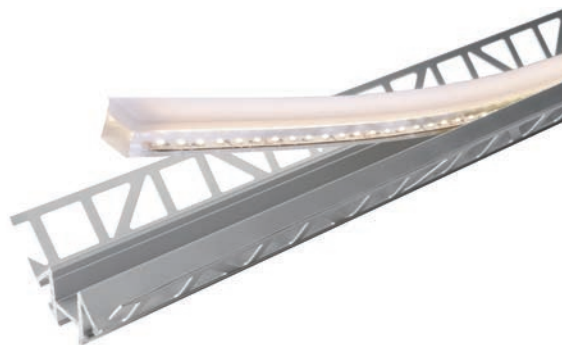

covers | PMMA [Polymethylmethacrylat]

clear matt milky

end caps set | 2 pieces **3,95 €**



1m	983000	983002	983004	6,95 €
2m	983001	983003	983005	13,95 €
3m	983006	983007	983008	20,95 €

 grey **978211**

With the kind support of BEST Bellemann Elektro Service Team GmbH, Reuenberg-Malschenberg



EL-03-12

tile profile | built-in | closing
for LED stripes up to 13,3 mm width



975360	■ 1,25m aluminium anodized	23,95 €
975361	■ 2,5m aluminium anodized	47,95 €
975364	□ 1,25m white mat	23,95 €
975365	□ 2,5m white mat	47,95 €
975367	■ 2,5m aluminium brushed	47,95 €
975369	■ 2,5m aluminium natural	47,95 €

tile thickness designed up to max. 12 mm

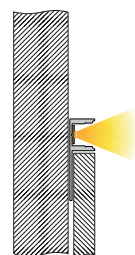
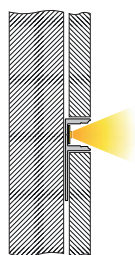
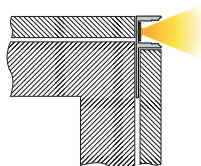
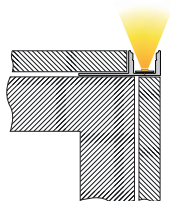
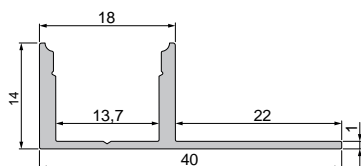

SOFT GROUTING

optionally available as customised special design
more information on page 819

tile profile	light colour	item	rm. price
EL-03-12	RGB+2700K	840370	334,95 €

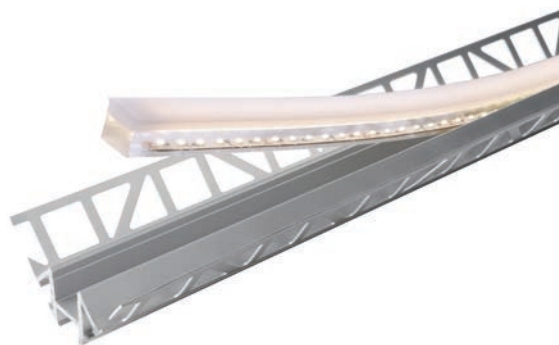

covers | PMMA [Polymethylmethacrylat]

clear matt milky



1m	983020	983022	983024	6,95 €
2m	983021	983023	983025	13,95 €
3m	983028	983027	983026	20,95 €

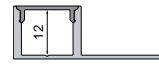

1m	984022	984024	6,95 €
2m	984023	984025	13,95 €
3m		984026	20,95 €

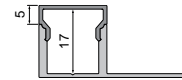

With the kind support of BEST Bellemann Elektro Service Team GmbH, Rauenberg-Malschenberg



EA-03-12

tile profile | closing
for LED stripes up to 13 mm width

975390	■	2m aluminium anodized	32,95 €
975391	■	3m aluminium anodized	49,95 €
975394	□	2m white mat	32,95 €
975395	□	3m white mat	49,95 €

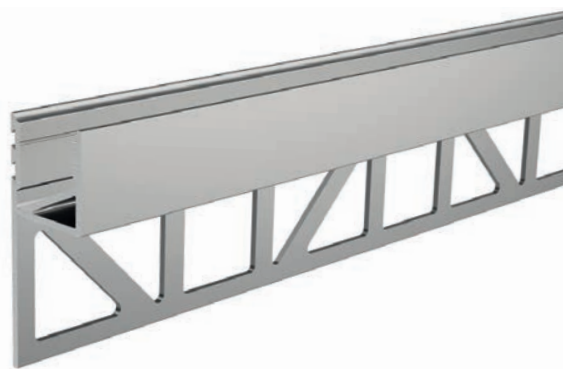

tile thickness designed up to max. 12 mm

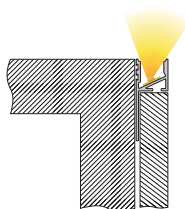
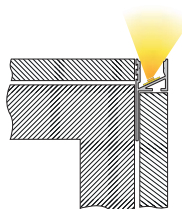
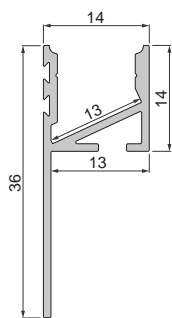

SOFT GROUTING

optionally available as customised special design
more information on page 819

tile profile	light colour	item	rm. price
EA-03-12	2700K	840363	324,95 €
EA-03-12	RGB	840367	324,95 €

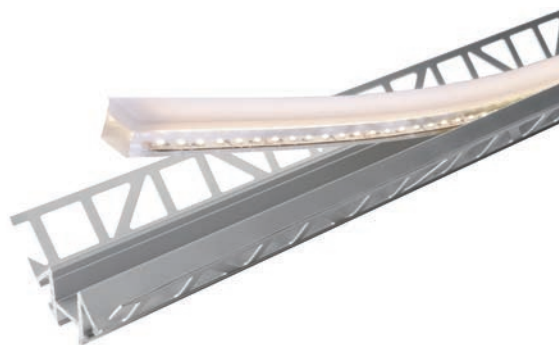

covers | PMMA [Polymethylmethacrylat]

clear matt milky

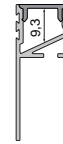

1m **983000** **983002** **983004** **6,95 €**

2m **983001** **983003** **983005** **13,95 €**

3m **983006** **983007** **983008** **20,95 €**

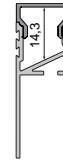

1m **984002** **984004** **6,95 €**

2m **984003** **984005** **13,95 €**



EV-01-08

tile profile | inside corner
for LED stripes up to 9,3 mm width

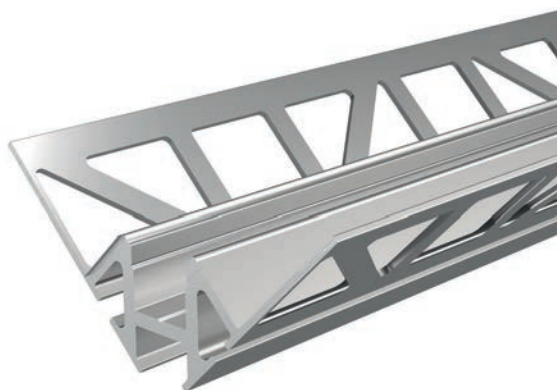

975343	■	2m aluminium anodized	52,95 €
975341	■	2,5m aluminium anodized	65,95 €
975344	■	3m aluminium anodized	79,95 €
975345	■	3m aluminium natural	79,95 €

tile thickness designed up to max. 9 mm

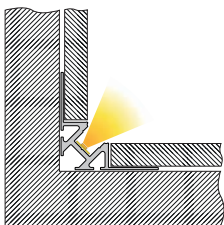
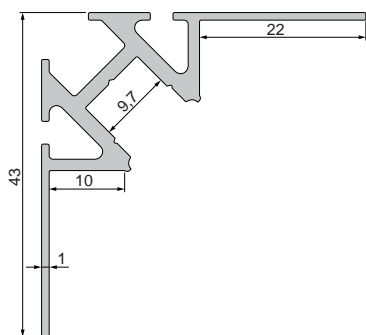

SOFT GROUTING

optionally available as customised special design
more information on page 819

tile profile	light colour	item	rm. price
EV-01-08	2700K	840364	274,95 €
EV-01-08	RGB	840368	274,95 €

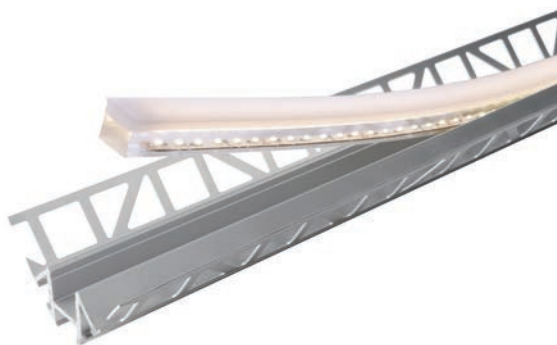

covers | PMMA [Polymethylmethacrylat]

clear matt milky



1m	983000	983002	983004	6,95 €
2m	983001	983003	983005	13,95 €
3m	983006	983007	983008	20,95 €



1m		985504	6,95 €
2m		985505	13,95 €
3m		985508	20,95 €

end caps set | 2 pieces **3,95 €**

grey



978221

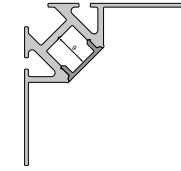

grey



980501

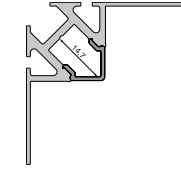

EV-01-12

tile profile | inside corner
for LED stripes up to 13,3 mm width

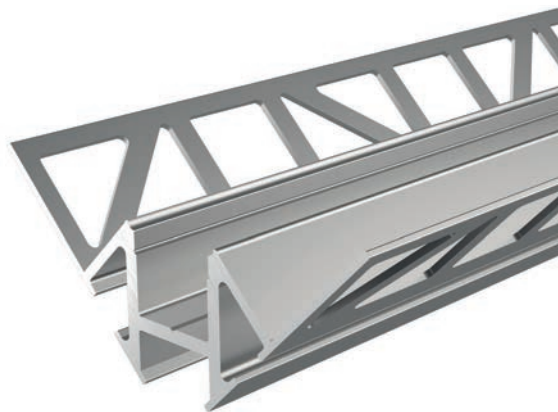

975370	■	1,25m aluminium anodized	39,95 €
975371	■	2,5m aluminium anodized	79,95 €
975375	□	2,5m white mat	79,95 €
975376	■	1,25m aluminium brushed	39,95 €
975377	■	2,5m aluminium brushed	79,95 €
975379	■	2,5m aluminium natural	79,95 €

tile thickness designed up to max. 12 mm

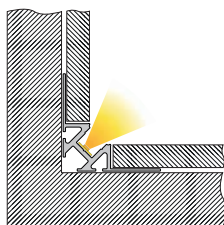
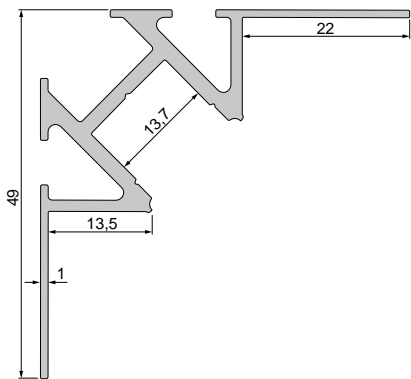

SOFT GROUTING

optionally available as customised special design
more information on page 819

tile profile	light colour	item	rm. price
EV-01-12	RGB+2700K	840371	334,95 €

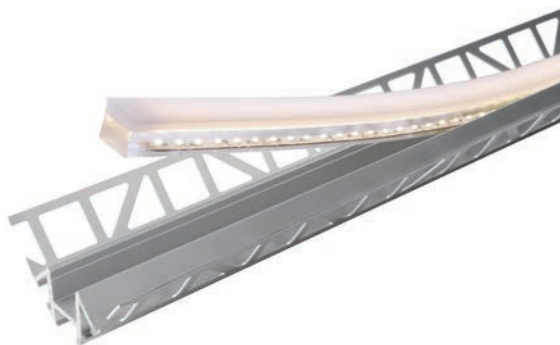

covers | PMMA [Polymethylmethacrylat]

clear matt milky

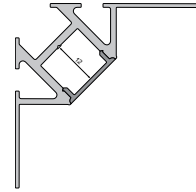

1m	983020	983022	983024	6,95 €
2m	983021	983023	983025	13,95 €
3m	983028	983027	983026	20,95 €



EV-02-08

tile profile | outside corner
for LED stripes up to 9,3 mm width

975350	■ 1,25m aluminium anodized	32,95 €
975352	■ 2m aluminium anodized	52,95 €
975351	■ 2,5m aluminium anodized	65,95 €
975353	■ 3m aluminium anodized	79,95 €



tile thickness designed up to max. 9 mm

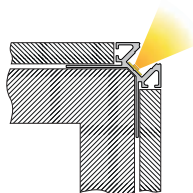
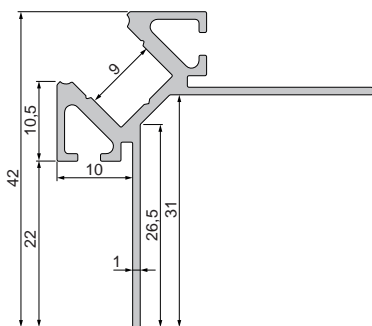

SOFT GROUTING

optionally available as customised special design
more information on page 819

tile profile	light colour	item	rm. price
EV-02-08	2700K	840365	274,95 €
EV-02-08	RGB	840369	274,95 €

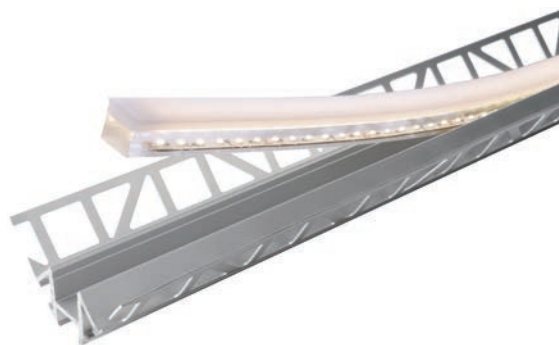

covers | PMMA [Polymethylmethacrylat]

clear matt milky



1m	983000	983002	983004	6,95 €
2m	983001	983003	983005	13,95 €
3m	983006	983007	983008	20,95 €



1m		985504	6,95 €
2m		985505	13,95 €
3m		985508	20,95 €

end caps set | 2 pieces **3,95 €**

■ grey



978231

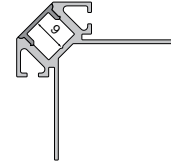

■ grey



980511

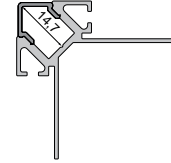

EV-02-12

tile profile | outside corner
for LED stripes up to 13,3 mm width

- 975381** 2,5m aluminium anodized
- 975384** 1,25m white mat
- 975385** 2,5m white mat
- 975389** 2,5m aluminium natural

79,95 €

39,95 €

79,95 €

79,95 €

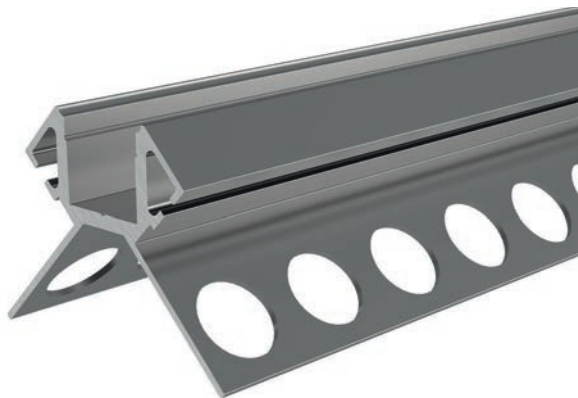

tile thickness designed up to max. 12 mm

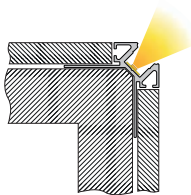
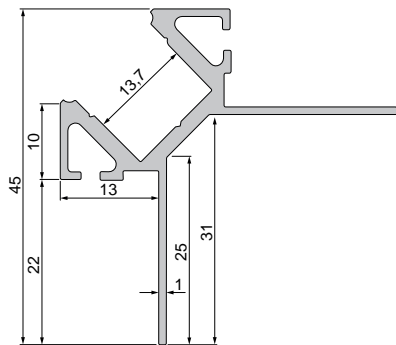

SOFT GROUTING

optionally available as customised special design
more information on page 819

tile profile	light colour	item	rm. price
EV-02-12	RGB+2700K	840372	334,95 €

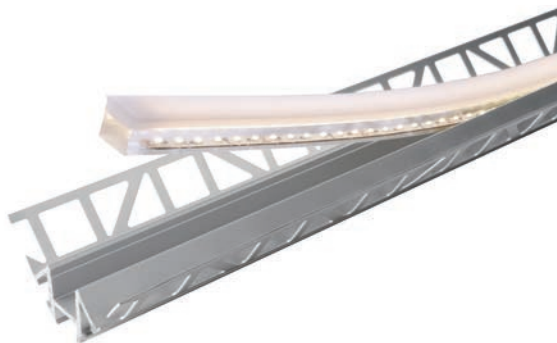

covers | PMMA [Polymethylmethacrylat]

clear matt milky

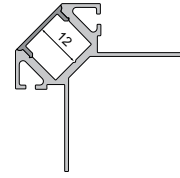

1m	983020	983022	983024	6,95 €
2m	983021	983023	983025	13,95 €
3m	983028	983027	983026	20,95 €





With the kind support of BEST Bellemann Elektro Service Team GmbH, Rauenberg-Malschenberg



profiles for outdoor

Outdoor areas have different requirements than indoor areas. Our IP profiles are walkable and passable and inspire as a highlight in any outdoor design.

AU-04-12

IP-Profil | built-in/mounting | walkable
for LED stripes up to 12,3 mm width



970722	■	1m aluminium anodized	9,95 €
970720	■	1,25m aluminium anodized	12,95 €
970723	■	2m aluminium anodized	19,95 €
970721	■	2,5m aluminium anodized	24,95 €
970724	■	3m aluminium anodized	29,95 €
970725	■	3m aluminium natural	29,95 €

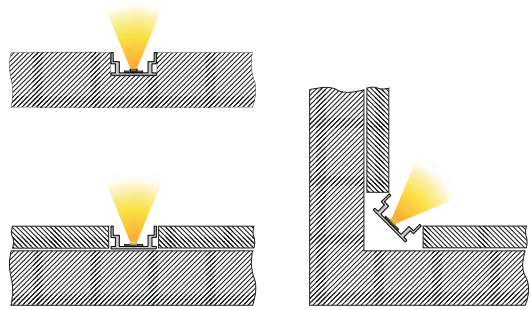
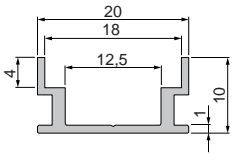

covers | Makrolon [polycarbonate]
walkable | material strength: 4mm
light diffusion | extremely impact resistant

end caps set | 2 pieces **3,95 €**

clear matt milky



2m

988025 15,95 €

3m

988028 23,95 €

 grey



981001



With professional processing, a protection class of up to IP65 can be achieved. Before installation, please refer to the information on page 802 before installation.

930104 natural stone sealant | 310ml cartridge
transparent | for adhesion of cover

32,95 €



930103 sealant smoothing agent | 400ml tin
for clean stripping and to improve the surface of the sealant

32,95 €



ET-05-12

IP-Profil | built-in | walkable
for LED stripes up to 12,3 mm width



975722	■	1m aluminium anodized	9,95 €
975720	■	1,25m aluminium anodized	12,95 €
975723	■	2m aluminium anodized	19,95 €
975721	■	2,5m aluminium anodized	24,95 €
975724	■	3m aluminium anodized	29,95 €

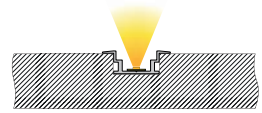
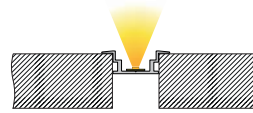
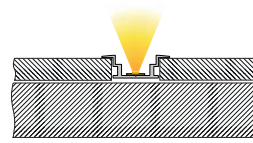
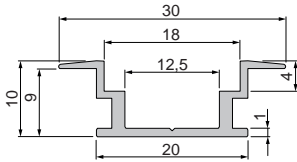

With the kind support of Oktec, Eisingen

covers | Makrolon [polycarbonate]
walkable | material strength: 4mm
light diffusion | extremely impact resistant

end caps set | 2 pieces **3,95 €**

clear matt milky



2m

988025 15,95 €

3m

988028 23,95 €

 grey



981011

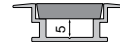

! With professional processing, a protection class of up to IP65 can be achieved.
■ Before installation, please refer to the information on page 802 before installation.

930104 natural stone sealant | 310ml cartridge
transparent | for adhesion of cover

32,95 €



930103 sealant smoothing agent | 400ml tin
for clean stripping and to improve the surface of the sealant

32,95 €



AU-05-15

IP-Profil | built-in/mounting | walkable
for LED stripes up to 15,6 mm width

- 970740 1m aluminium natural
- 970741 2m aluminium natural

17,95 €

35,95 €

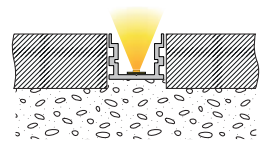
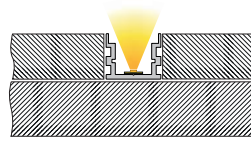
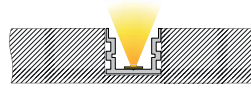
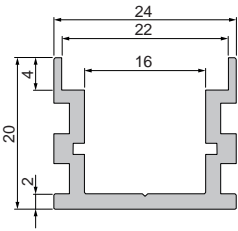

With the kind support of Elektro Grün, Neustadt an der Weinstraße

covers | Makrolon [polycarbonate]
walkable | material strength: 4mm
light diffusion | extremely impact resistant

end caps set | 2 pieces **3,95 €**

clear matt milky

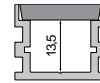

1m	988084	8,95 €
2m	988085	17,95 €

grey

981031

970764 carrier profile for LED stripes
aluminium natural | 1m

6,95 €

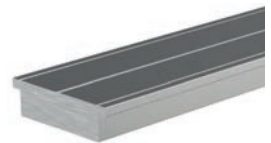

! With professional processing, a protection class of up to IP65 can be achieved.
■ Before installation, please refer to the information on page 802 before installation.

930104 natural stone sealant | 310ml cartridge
transparent | for adhesion of cover

32,95 €



930103 sealant smoothing agent | 400ml tin
for clean stripping and to improve the surface of the sealant



32,95 €

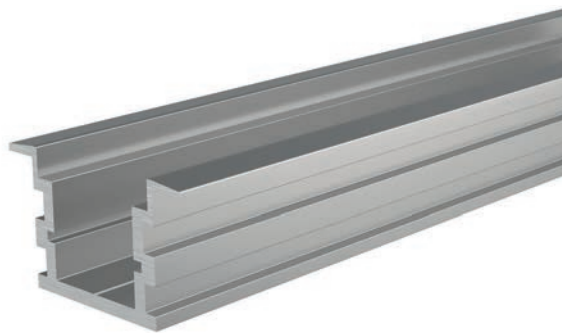

ET-05-15

IP-Profil | built-in | walkable
for LED stripes up to 15,6 mm width



- 975740  1m aluminium natural
- 975741  2m aluminium natural

17,95 €

35,95 €

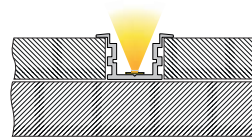
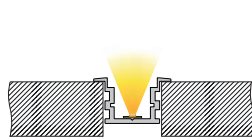
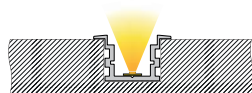
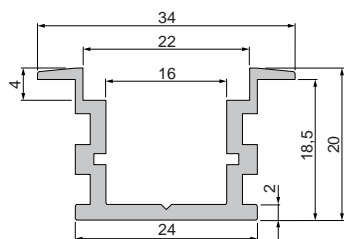

With the kind support of LED-TEC, Gira/Italien | Foto: fotoeichhorn

covers | Makrolon [polycarbonate]
walkable | material strength: 4mm
light diffusion | extremely impact resistant

end caps set | 2 pieces **3,95 €**

clear matt milky

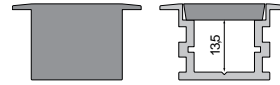

1m	988084	8,95 €
2m	988085	17,95 €

grey

981041

970764 carrier profile for LED stripes
aluminium natural | 1m

6,95 €

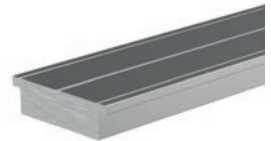

! With professional processing, a protection class of up to IP65 can be achieved.
■ Before installation, please refer to the information on page 802 before installation.

930104 natural stone sealant | 310ml cartridge
transparent | for adhesion of cover

32,95 €



930103 sealant smoothing agent | 400ml tin
for clean stripping and to improve the surface of the sealant

32,95 €



EU-01-12

IP-Profil | built-in | passable
for LED stripes up to 12 mm width



975781



2m aluminium natural

64,95 €



Foto: Daniel Vießer - Architekturfotografie, Karlsruhe

covers | Makrolon [polycarbonate]
 passable | material strength: 5mm
 light diffusion | extremely impact resistant

end caps set | 2 pieces **3,95 €**

clear matt milky

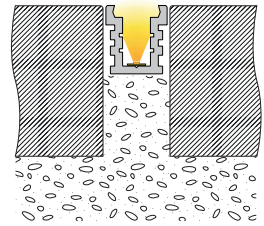
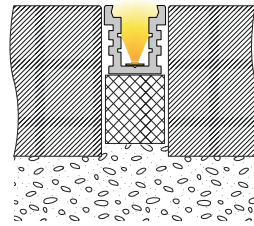
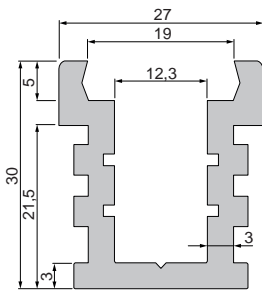
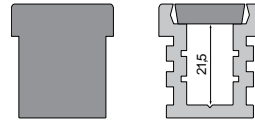

1m	988054	8,95 €
2m	988055	17,95 €

grey

981021

970762 carrier profile for LED stripes
 aluminium natural | 1,25m

5,95 €

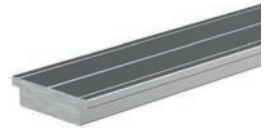
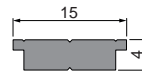

990109 foam support | 123,5 x 3,3 x 3 cm
 plastic | hard foam

6,95 €



With professional processing, a protection class of up to IP65 can be achieved.
 Can be driven over with a maximum load of 1 tonne.
 We recommend our matching foam underlay.
 Please refer to the information on page 802 before installation.

930104 natural stone sealant | 310ml cartridge
 transparent | for adhesion of cover

32,95 €



930103 sealant smoothing agent | 400ml tin
 for clean stripping and to improve the surface of the sealant

32,95 €



Attention! Please take into account before assembly:

For an optimal and durable result, please consider the respective climate and weather conditions before installation.

influence of solar radiation:

Please take the sun's path into account before installation. Permanent and intensive sunlight can damage the LED stripe – even when it is switched off. Every material expands and contracts differently. Install the profiles taking into account the temperature fluctuations and the resulting expansion coefficients. Please note that the materials aluminium, PMMA, PC and Makrolon [profiles/covers] can expand to different extents with temperature changes, which can affect the tightness. **This is not a product defect, but a normal physical process.**

influence of water and frost:

Before installation, please take into account that no standing water can form after the profile has been built-in, e.g. in case of rain. In case of improper processing and different temperatures, condensation can form to varying degrees or water can penetrate through capillary action. Standing or penetrating water or moisture can thus impair the tightness in the event of frost and damage the LED stripe. To protect the LED stripe, we recommend half or full watering of the profile [depending on stress and use].

Please note that we cannot accept any liability for further processing or finishing on your part or for tightness, positioning and attachment.

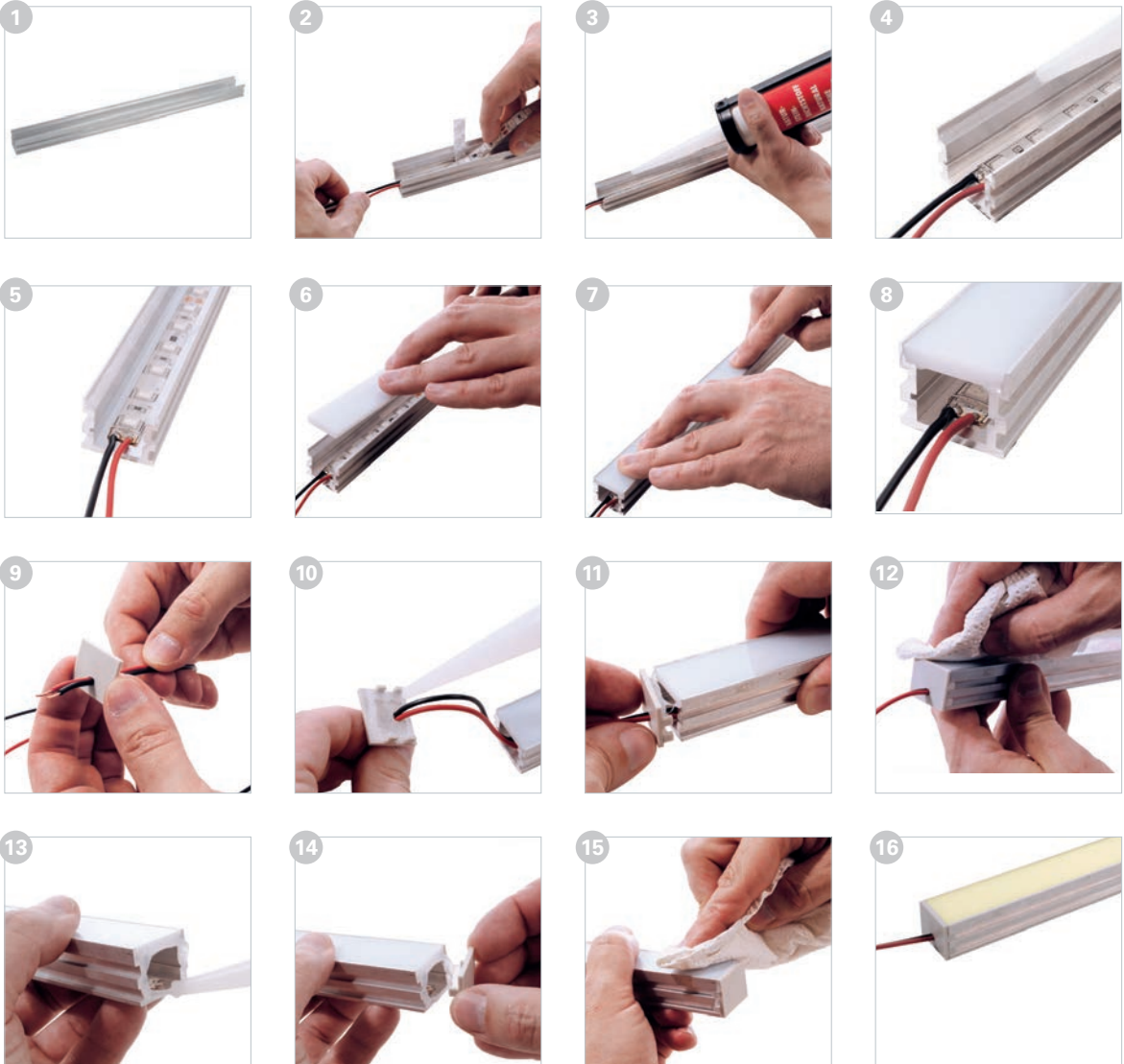

ASSEMBLY INSTRUCTIONS

- 1 for an optimal working base, the profile must be free of grease and dust
- 2 when gluing in the LED stripe, place it on one side and carefully move it vertically press on piece by piece
- 3 after attaching the LED stripe, the cover is glued in place
- 4 continuous, even layer of natural stone sealant/silicone transparent on the entire surface apply the contact surface of the profile
- 5 in order to ensure a continuously closed bonding surface, the sealant must be applied without be applied to free places
- 6 loosen the tapered cover evenly with the narrow side facing downwards insert into the profile
- 7 from one side, press on the cover piece by piece with even vertical movements
- 8 the cover must be flush with the profile at the beginning and end
- 9 lead the connection cables through the end cap [hole in the end cap must be made manually]
- 10 to seal the profile at the end faces, sealant around the end cap and attach in the cable gland
- 11 push the end cap evenly onto the profile
- 12 remove excess material/sealant and clean surface
- 13 repeat the procedure for the second end cap [sealant can be applied to end cap or profile with cover]
- 14 push on the end cap until it is completely in place
- 15 again remove excess material/sealant and clean surface
- 16 after correct and careful processing, a protection class of up to IP65 can be achieved always carry out a function test before further installation

PLAYING HARDBALL

In some applications, even the best profiles are not sufficient to integrate LED stripes safely. There is a solution for these situations as well.

LED stripes are among the most flexible and versatile lighting solutions available and can be used in combination with various, partly specialised LED profiles in almost any application. However, as soon as the highest demands are placed on the durability and resistance of installed LED stripes, for example, through permanent trafficability, special solutions are required.

With the Litus series, we offer such a special solution. The special feature of this complete set is the special hard encapsulation technology of the profile, which we would like to explain to you in more detail below.

HARD GROUTING: 3 ESSENTIAL ADVANTAGES

advantage 1 [over glass]:

Polyurethane hard encapsulation does not splinter

advantage 2 [over plastic covers]:

no problems with subsequent linear expansion [conventional plastics react to thermal effects].

advantage 3:

fully encapsulated profiles do not have any cavities that can fill with moisture and dirt and impair the light image or functionality

With hard encapsulation, the products are fully encapsulated in a special multi-layer process to protect the LED module all year round from the effects of weather, water penetration and mechanical influences. A particularly long-term stable polyurethane (a plastic or synthetic resin) is used for this purpose. In this way, the integrated LEDs are completely encapsulated to exclude damage caused by moisture. In addition, the hard cast surface is highly robust and ensures a homogeneous light image due to the opacity. A special feature is the integrated cavity, which acts as a pressure relief for the LEDs.

COMPLETE SET LITUS

With the Litus series for outdoor use, DEKO-LIGHT offers a ready-made complete set consisting of aluminium profile, permanently installed LED stripe, cover, end caps and connection cable. Thanks to the chilled casting process, the Litus profiles are suitable for a maximum load of 1 tonne – higher loads can be realised by means of damping with our optional foam support. The profiles can be mounted using either mortar concrete or ceramic adhesive.



The Litus sets are optionally available with two cores [V-, V+] or five cores [R, G, B, W, V+] and are suitable, among other things, for light line marking, civil engineering, accent lighting or for use in exhibition and sales areas.

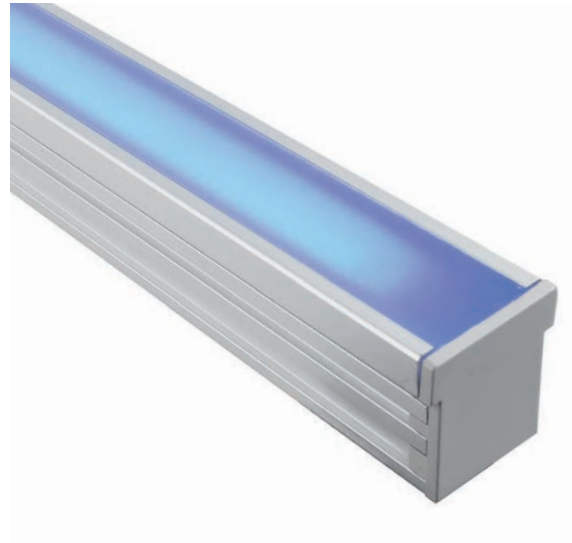
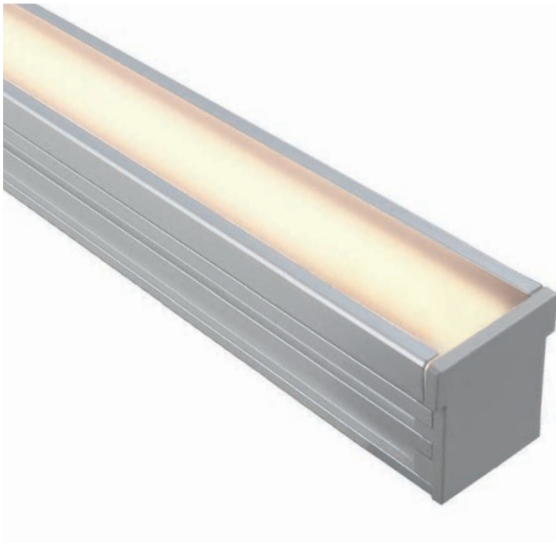



LITUS LED PROFIL COMPLETE SET | PASSABLE

- Material: aluminium
- connection stripe: 2 leads [V-, V+] | 5 leads [R, G, B, W, V+]
- incl. 2m connection cable with open tinned wire ends

847015		3000 K	96 LED	9,8 W	131 lm	1000 x 27 x 30 mm	379,95 €
847016		3000 K	192 LED	19,0 W	239 lm	2000 x 27 x 30 mm	759,95 €
847017	 	460 - 620 nm 3000 K	192 LED	20,3 W	190 lm	1000 x 27 x 30 mm	399,95 €
847018	 	450 - 630 nm 3000 K	384 LED	34,0 W	289 lm	2000 x 27 x 30 mm	799,95 €



accessories

990109 foam support | 123,5 x 3,3 x 3 cm | plastic | hard foam **6,95 €**

accessories depending on the selected variant, performance and control request

power supply from page 896

dimmer and controller from page 940

mounting accessories from page 1003



WW NW

COB stripes

1CH | 24V
from page 824



WW CW

COB stripes

2CH | 24V
from page 828



RGB

COB stripes

3CH | 24V
from page 830



WW NW CW

standard stripes

1CH | 12V
from page 832



WW NW CW

standard stripes

1CH | 24V
from page 836



WW NW

standard stripes

1CH | 48V
from page 842



WW CW

standard stripes

2CH | 12V
from page 846



WW CW

standard stripes

2CH | 24V
from page 848



RGB

standard stripes

3CH | 24V
from page 852



RGB WW NW CW

standard stripes

4CH | 24V
from page 856



RGB WW CW

standard stripes

3+2CH | 24V
from page 860



WW

D LENSE LINE

1CH | 24V
page 863



RGB

D LENSE LINE

3CH | 24V
page 865



ww

D FLEX LINE TOP-VIEW

1CH | 24V
from page 867



RGB

D FLEX LINE TOP-VIEW

3CH | 24V
page 871



RGB ww

D FLEX LINE TOP-VIEW

4CH | 24V
page 873



ww

D FLEX LINE SIDE-VIEW

1CH | 24V
from page 875



RGB

D FLEX LINE SIDE-VIEW

3CH | 24V
from page 878



RGB ww

D FLEX LINE SIDE-VIEW

4CH | 24V
page 881



ww nw

230V-Stripes

1CH
page 883

LED stripes

LITTLE 1X1: LED STRIPE POWER ADAPTER AND CONTROL

The planning and selection of electrical components for the commission and control of LED stripes can be a challenge. We explain this complex topic to you.

Why are there so many different options?

Depending on the type of LED stripe installed, they differ not only in terms of photometric values and required supply voltage, but also in terms of electrical connection, control and dimming. These factors often depend on where they are used and the local conditions, which is why the required operating resources - power adapters and control components – differ.

What does primary and secondary dimming mean?

Regardless of the type of luminaire, a distinction is made between primary and secondary dimming. Primary dimming means that the mains voltage [230V AC] applied to the mains unit is dimmed directly via a triac dimmer [rotary dimmer or built-in dimmer]. With secondary dimming, on the other hand, the output voltage of the power adapter is dimmed. In some cases, these so-called »PWM dimmers« are already integrated in the power adapter, in others they are fitted as an additional component behind the power adapter.

Sounds complicated? In practice, however, it's easier than expected! Since the control of 1-channel and multi-channel stripes is fundamentally different, we treat these two groups separately.

Operation of 1-channel/single stripes [WW, NW, CW]

- a) undimmed
- b) 230V mains voltage, dimmed via phase-cut dimmer [e.g. rotary dimmer]
- c) secondary dimming via radio remote control or app [RF system, Quasar]
- d) secondary dimming via DMX
- e) power supply units with integrated PWM dimmer module, controllable via Dali, 1-10V, KNX

a) 1-channel stripe – undimmed

Whenever a 1-channel stripe is used as a basic light or for indirect lighting and is to be operated permanently at full power, it can be connected directly to a suitable power adapter (be sure to observe the output voltage/power!). This operating mode is the simplest way to operate LED stripes.

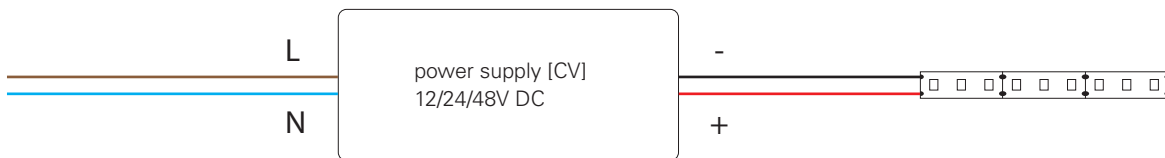

matching power supplies p. 899-902, 905

b) 1-channel stripe – dimmed via primary dimmable mains unit with phase cut-off dimmer

If an LED stripe is to be dimmed, there are various possibilities depending on the required power and the existing wiring network: the simplest option is to dim the mains voltage directly via a triac dimmer, which in turn supplies the mains unit. The best known triac dimmer is the rotary dimmer. However, other triac systems can also be used if they are suitable electronic mains units (C-load). IMPORTANT: Please always pay attention to the rating data of all components and to the fact that only a few mains units are suitable for this type of dimming.

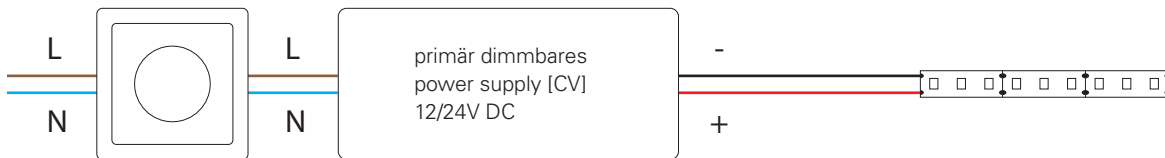

e.g. rotary dimmer [930060] S. 986 matching power supplies p. 904-905

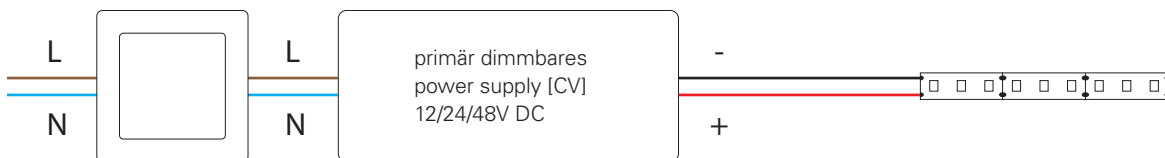

touch dimmer matching power supplies p. 904-905

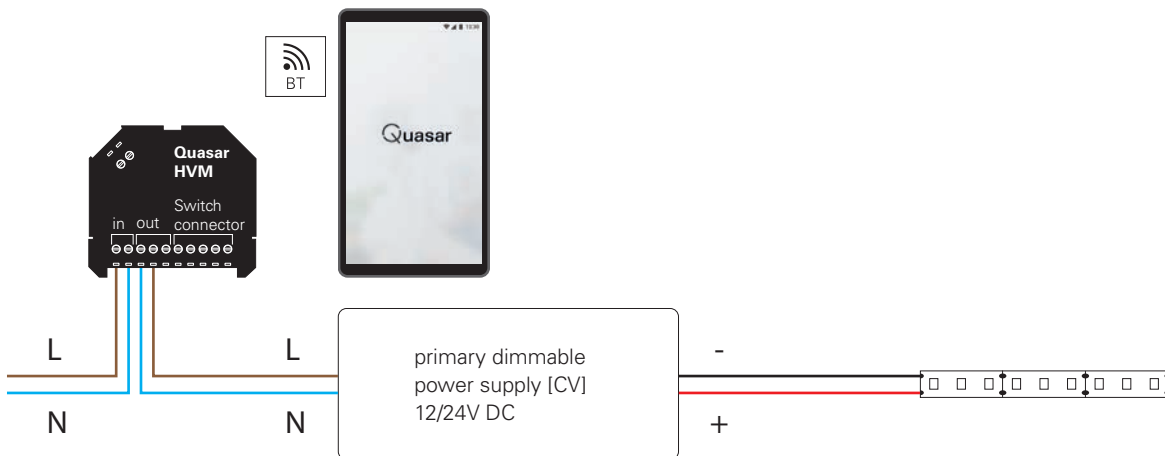

Quasar HVM [843007] S. 939 matching power supplies p. 904-905

c] 1-channel stripe – secondary dimming e.g. via radio remote control or app

Depending on the customer's performance requirements or operating preferences, other options are often necessary. For secondary dimming, the constant output voltage of the power adapter is dimmed using a downstream PWM dimmer. Different types and designs of PWM dimmers are available, for example radio remote control or smartphone app.

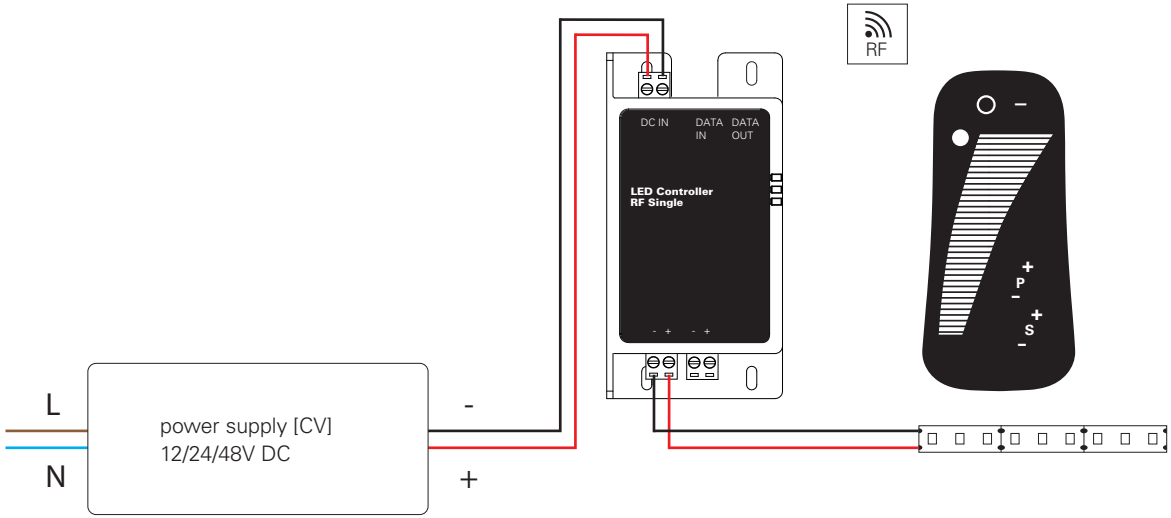

matching power supplies p. 899-902, 905

dimmed via remote control, RF system [843056] S. 946

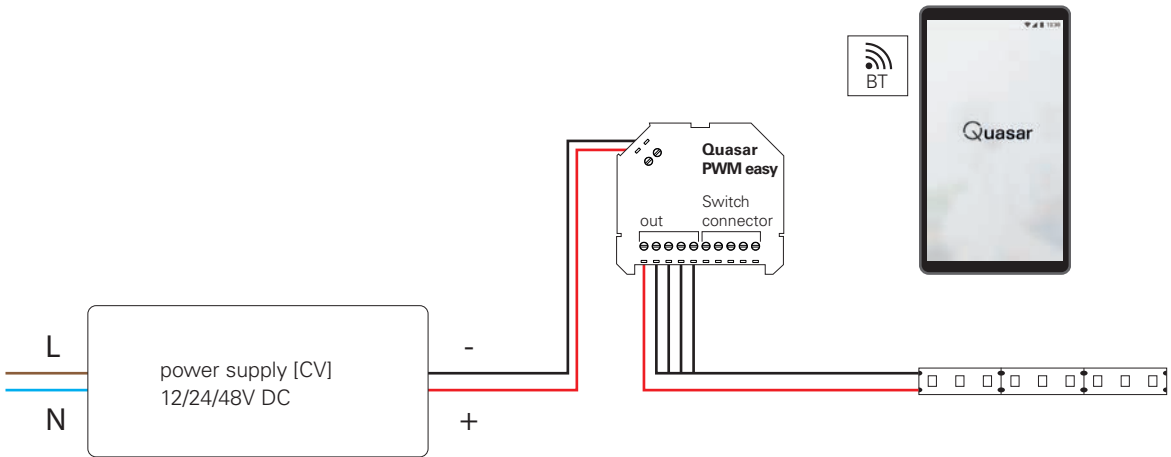

matching power supplies p. 899-902, 905

dimmed via smartphone app and/or additional pushbuttons, Quasar [843053] S. 941

d] 1-channel stripe – secondary dimming via DMX

DMX control is mainly used in theatres, event locations, bars and clubs, but it also offers advantages in other areas of application. Control is via a DMX signal supplied by a corresponding DMX controller. Various types of the latter exist, from a simple wall controller for 1-4 zones to a software solution in combination with a PC interface, allowing even the most complex control setups.

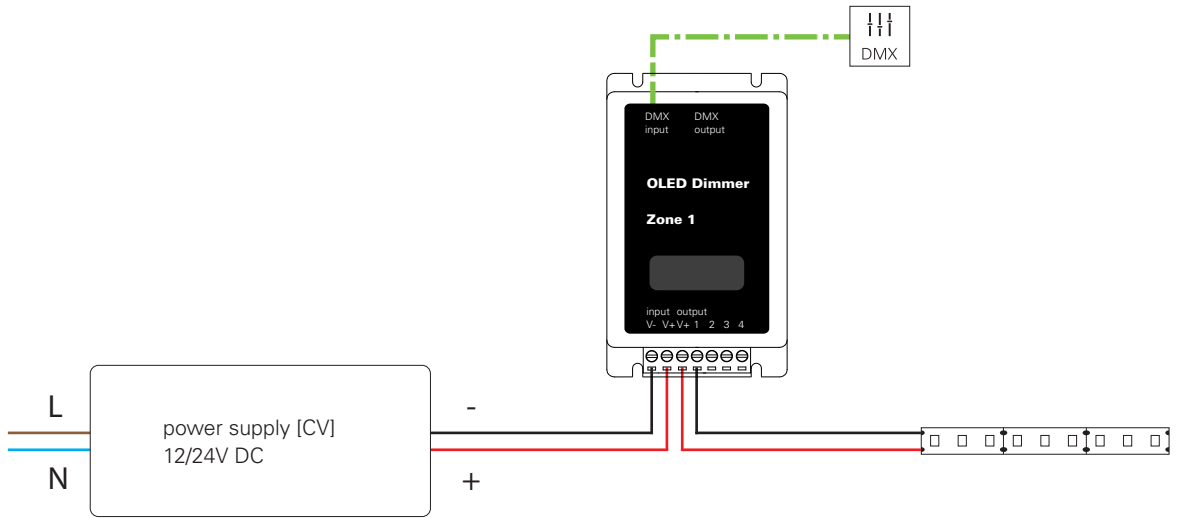

matching power supplies p. 899-902, 905

DMX controller from p. 950 | DMX dimmer from p. 951

e] 1-channel stripe on power adapter with integrated PWM dimmer, controllable by Dali, 1-10V, KNX

Power supplies with integrated PWM dimmers simplify installation as only one component needs to be fitted and wired. The usual control signals from the building installation and automation can be used. For reasons of compatibility and comfort, I recommend gearing the selection to the building's existing control system as the mains units barely differ visually and in their design. Please note that the different control signals are generally NOT compatible with each other and the corresponding power supply type must be used in each case.

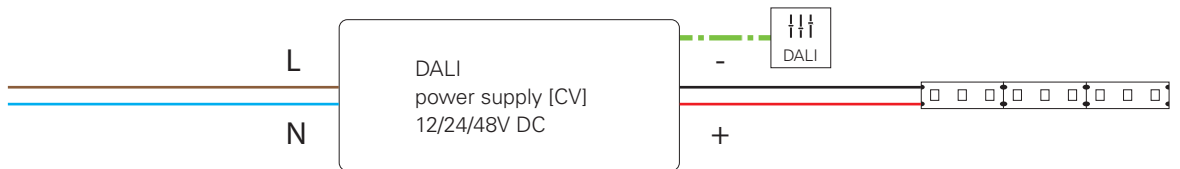

matching power supplies p. 908-909

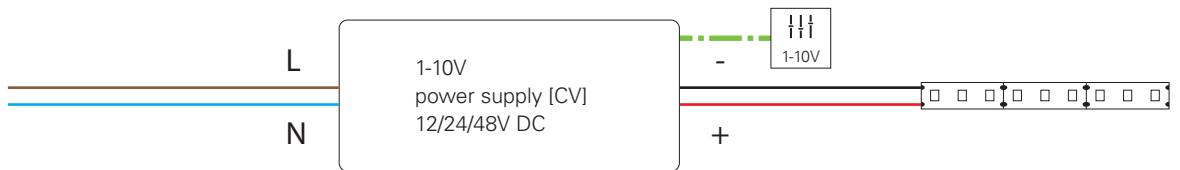

matching power supplies p. 906-907

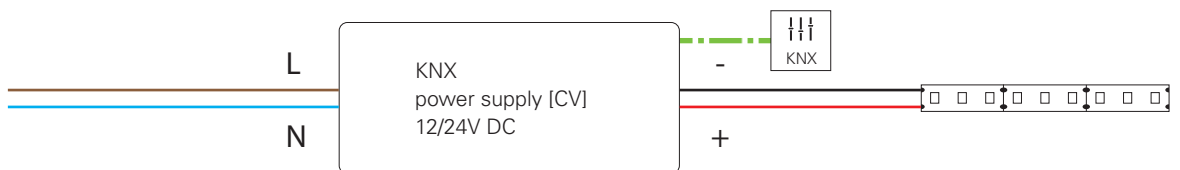

matching power supplies p. 910

Operation of multi-channel stripes [2-4 channels / WW-CW, RGB, RGBW]

Multi-channel LED stripes [WW-CW, RGB, RGBW] must be dimmed simultaneously via several channels [two to four]. For example, the colour mixing of an RGB stripe requires that different brightnesses [dimming levels] of the individual colours red, green and blue are mixed together [additive colour mixing]. As a rule, a multi-channel PWM dimmer is connected behind the output voltage of a standard power adapter [without dimming function]. This generates the brightness values of the individual colours via remote control, app, DMX or DALI.

Operation of multi-channel stripes [2-4 channels / WW-CW, RGB, RGBW]

- f) secondary dimming / colour control via radio remote control or app [RF system, Quasar]
- g) secondary dimming / colour control via DMX signal
- h) secondary dimming / colour control via DALI

f] 2-4-channel-stripe – secondary dimming via remote control or app

RGBW control

dimmed via remote control,
RF system [e.g. 843057 WW-CW, 843058 RGB,
843059 RGBW] from p. 946
matching power supplies p. 899-902, 905

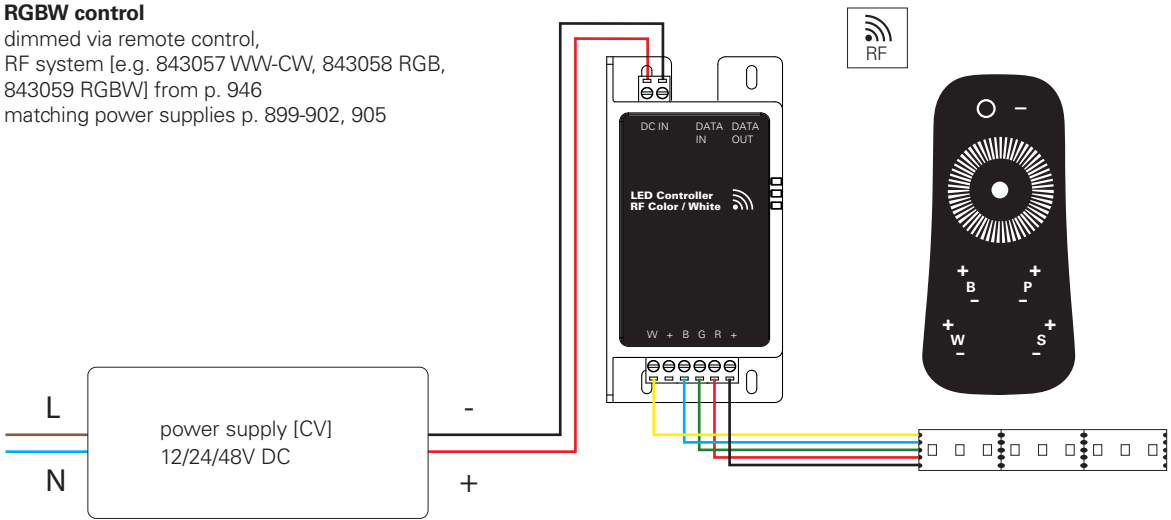

RGBW control

dimmed via smartphone app and/or
additional pushbuttons, Quasar [843056] p. 941
matching power supplies p. 899-902, 905

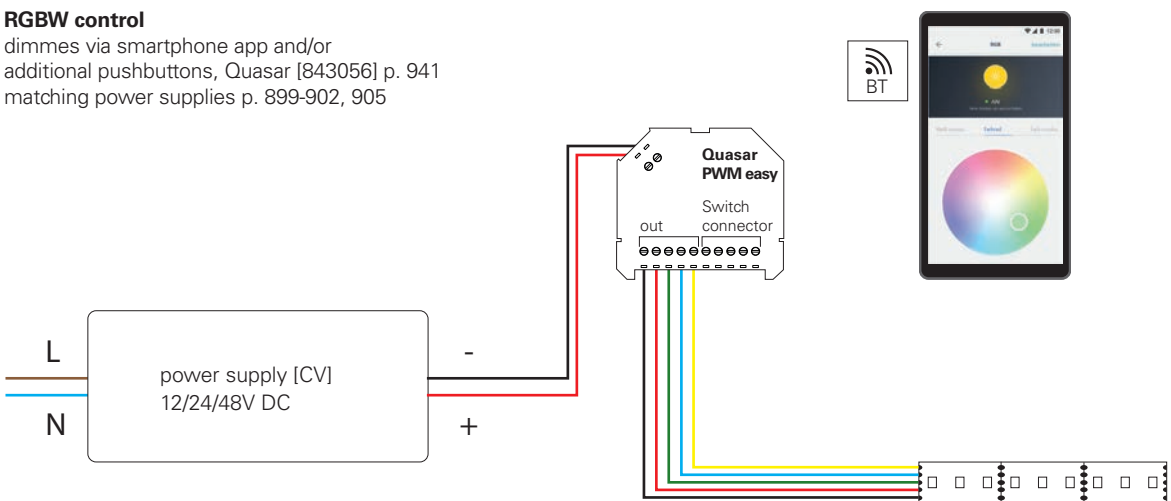

g] 2-4-channel-stripe – secondary dimming via DMX

The control of multi-channel LED stripes by DMX differs only in the use of the multi-channel LED stripe concerned channel DMX PWM dimmer and a suitable DMX controller.

RGBW control

DMX controller from p. 950
 DMX dimmer from p. 951
 matching power supplies p. 899-902, 905

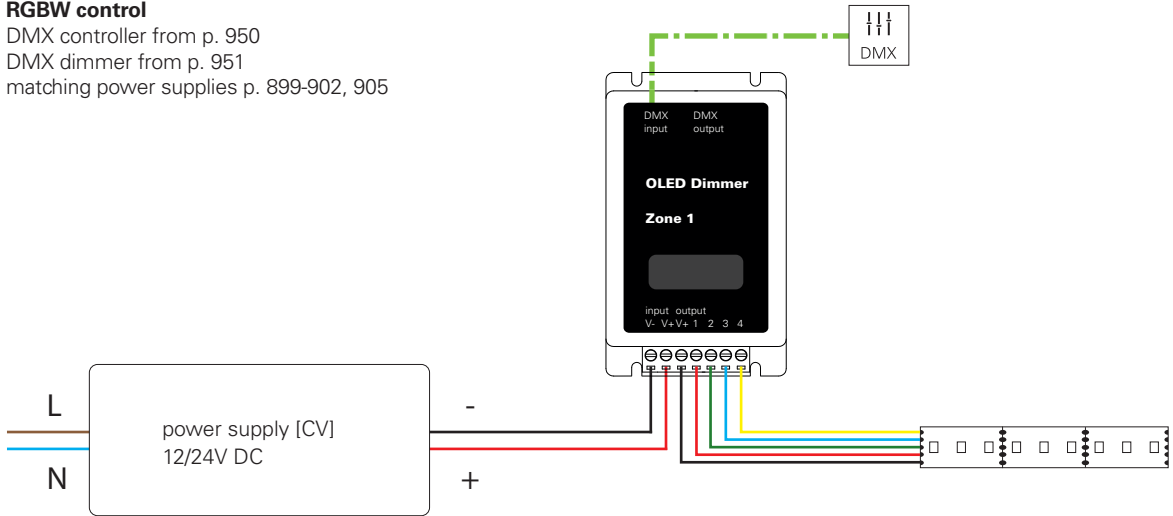

h] 2-4-channel-stripe – secondary dimming via Dali

As with the control of multi-channel stripes by DMX, in the case of control by Dali, a suitable Dali PWM dimmer is connected downstream of the mains unit which receives pre-programmed control commands. As with 1-channel control by Dali, this type is particularly recommended if an existing Dali network is already installed.

WW/CW control

DALI-PWM dimmer p. 962
 matching power supplies p. 899-902, 905

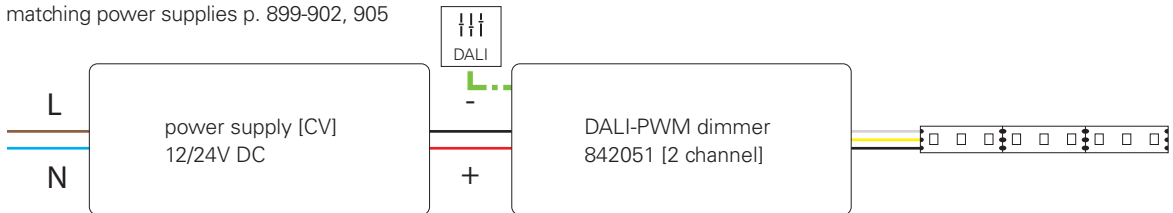

RGB control

DALI-PWM- dimmer p. 962
 matching power supplies p. 899-902, 905

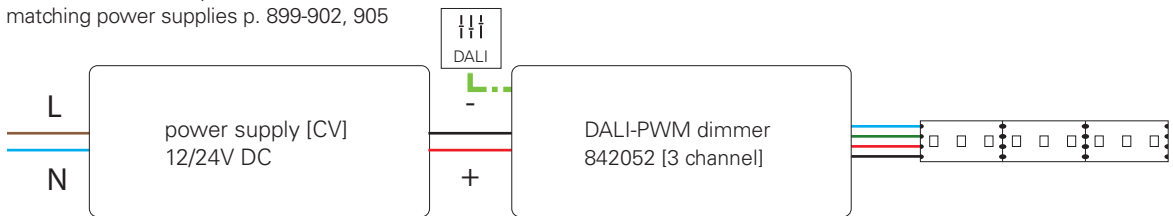

RGBW control

DALI-PWM dimmer p. 963
 matching power supplies p. 899-902, 905

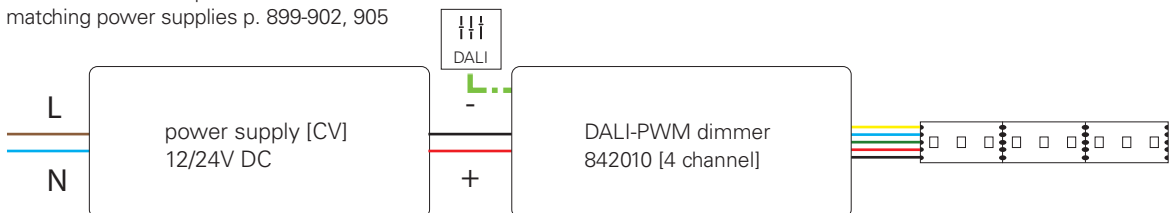

THINGS TO KNOW ABOUT LED STRIPES

Which LED chips and sizes are most commonly installed in our company?

On these two pages, we focus on LED stripes, or more precisely on the LED chips installed on them. These are installed in a wide variety of sizes, power classes, quantities and distances for a wide variety of stripes in 12V, 24V, 48V and 230V.

quality promise

Our LED stripes are subjected to constant quality control during production. Thus, we can guarantee the high quality of our LED stripes.

STRUCTURE OF A STANDARD LED CHIP

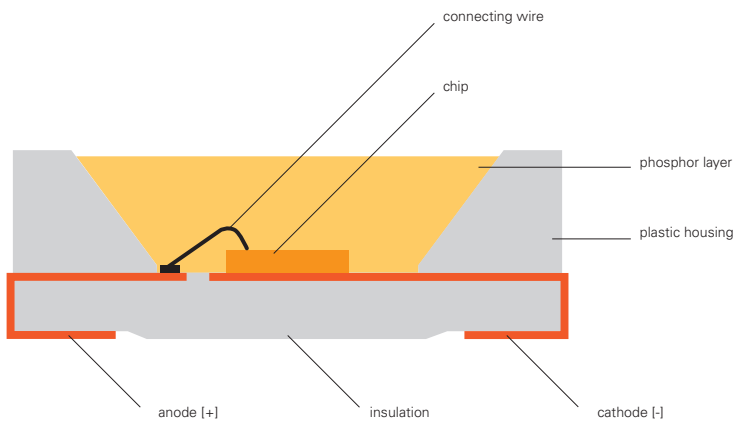

WHAT DO THE NUMBERS MEAN FOR A LED STRIPE?

The numbers clearly indicate the size [width and length] and shape of the LED chips installed on a carrier [stripe]. For example, the LED chip 5050 – one of the world's most

frequently used LED chips – has a width of LED chips – each with a length and width of 5 mm. A 2835 LED chip therefore has a width of 2.8 mm and a length of 3.5 mm.

SMD 5050 | single
chip dimensions: 5 x 5 mm

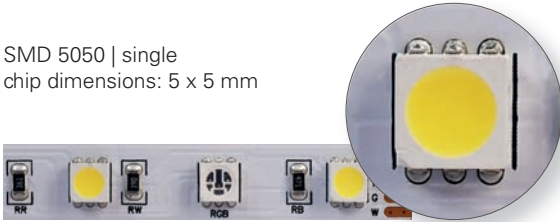

SMD 2835 | single
chip dimensions: 2,8 x 3,5 mm

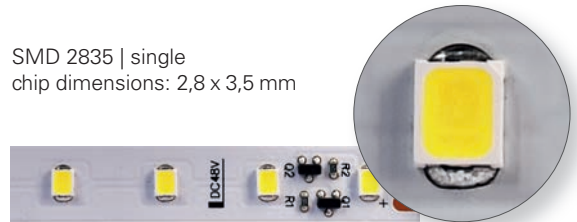

SMD 5050 | RGB
chip dimensions: 5 x 5 mm

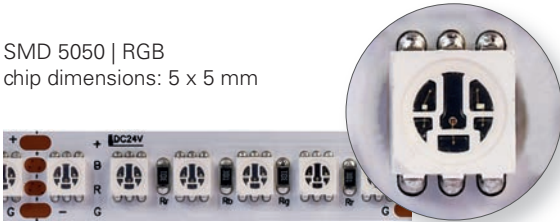

SMD 2835 | WW / CW
chip dimensions: 2,8 x 3,5 mm



SMD 5050 | WW / CW
chip dimensions: 5 x 5 mm



SMD 2216 | single
chip dimensions: 1,6 x 2,2 mm



SMD 3528 | single
chip dimensions: 2,8 x 3,5 mm

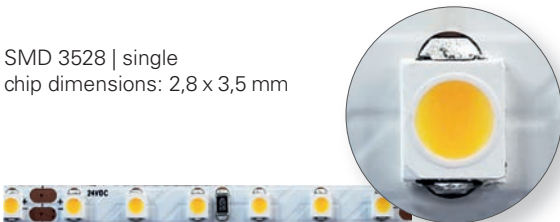

SMD 1808 | single
chip dimensions: 0,8 x 1,8 mm

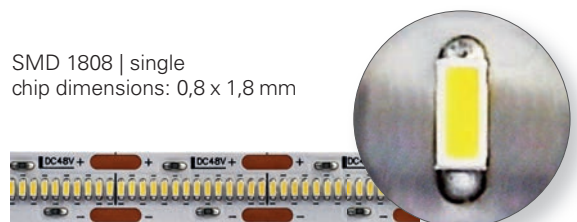

COB | single

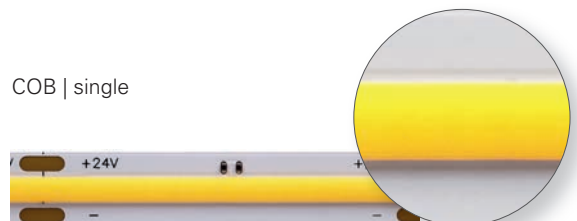

ASSEMBLY & HANDLING

LED stripes are usually assembled, i.e. shortened to individually required lengths, in order to be able to be installed precisely in the respective project. The stripes must be cut correctly to avoid the failure of individual chips or segments. The following illustrations show the correct handling:

RIGHT: LED stripe is cut at the right place [marked places / copper plates]. With a correctly cut LED stripe, all segments light up completely.



WRONG: LED stripe is not cut at the marked point. The incorrectly cut LED stripe is therefore damaged, causing a complete segment to fail and no longer light up.



MOUNTING & HANDLING

After the LED stripes have been correctly assembled, there are other sources of error that must be avoided during handling and installation. In the following, we show you the four most frequently occurring problems:

LED stripe with torn connection cable and LED chip. This damage can be caused by e.g. twisting, bending, pressing on by objects / friction and force during insertions and feed-throughs.



RIGHT: The LED stripe has been installed taking into account the minimum bending radius. This ensures that the LED stripe is not damaged during installation.



WRONG: The LED stripe was bent due to carelessness or an installation situation at a corner. The damaged segment no longer lights up, the solder joints, LED chips or carriers have been damaged.



RIGHT: If an LED stripe is to be laid vertically around a corner, the bending radius cannot usually be maintained. To avoid the problem described above, the stripe should be cut at a marked point and routed over the corner using a soldered wire connection.



WRONG: The LED stripe was bent within the segment. As a result, solder joints, LED chips and/or substrates have been damaged and the damaged segment begins to flicker or no longer lights up permanently.



RIGHT: If the LED stripe is to be laid horizontally around a corner, the stripe must be cut at a marked point and led around the corner using a soldered wire connection.



WRONG: The LED stripe was bent horizontally around the corner. The result: solder joints, LED chips and/or carriers have been damaged and the damaged segment begins to flicker or no longer lights up permanently.





CUSTOMISED SOFT GROUTING

Precisely fitting, flexible and of the highest quality - that's what we stand for and give you a 5-year guarantee. All assembled tapes are delivered with a 3m feed on one side and open tinned wire ends.

INSIGHT AND BACKGROUND KNOWLEDGE ABOUT A PRODUCT MADE IN GERMANY WITH A LOT OF KNOW-HOW

Here we show you the assembled strips from the back. You do not see the installed LED stripe here, but a metal stripe. The metal stripe is responsible for several things:

- it provides a flat and clean support surface for mounting the LED stripe
- it not only serves as a carrier for the LED stripe, but also enables precise positioning in the potting mould
- it improves the heat distribution/dissipation of the stripe
- it stabilises the completely assembled / moulded stripe

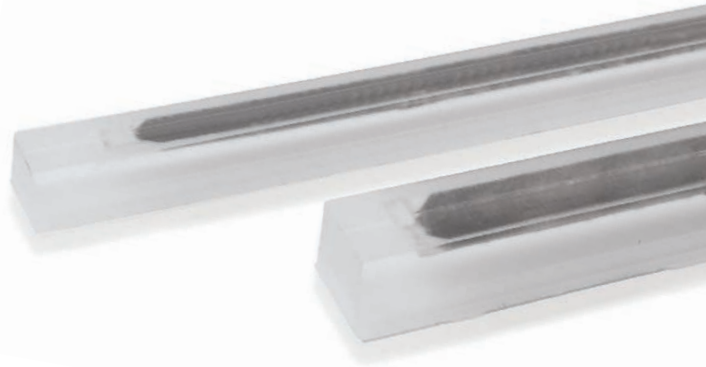

Below you can see a side view of the assembled tape. Through years of experience in potting technology, you receive a product of the highest quality and a great deal of know-how. The following design details are leading in this respect:

- The metal support with LED stripe is completely enclosed by the potting compound [floating potting, IP67 guaranteed].
- The cores of the feed are encapsulated in a kind of wave and the potting compound completely encloses the cores. [IP protection guaranteed, additional strain relief to protect the solder contacts from damage or breakage].
- Compared to the coloured top layer, the feed is cast slightly backwards, so that space is gained to better align the cores depending on the connection situation on site.
- The LED stripes are encapsulated with different flexible materials [different colouring / light transmission]. The clear potting in the lower area ensures the highest possible lumen yield and the upper milky coloured area ensures a homogeneous light pattern.
- The potted LED module fits perfectly into the corresponding tile profile, so there is no cavity for moisture or dirt.



SOFT GROUTING – THIS IS HOW IT WORKS

You know which tile profile you would like to install or has already been installed?

Please take this information and select your profile series from the table below. Depending on the profile series, you will receive 1 to 2 light colours for your profile to choose from. After determining the desired light colour, find out the article number of your soft cast. Smallest possible length 80 mm, longest possible length 2980 mm [depending on the length of the profile]. Tolerance +/- 2mm

You will receive a customised / encapsulated LED stripe incl. 3m feed and open tinned wire ends. You can press this stripe into your existing or separately available profile and remove it again if required.

profile series	light colour	lm/m	W/m	item	rm. price
EL-01-08	2700K	365lm	9,0W	840362	274,95 €
EL-01-08	RGB	440lm	17,5W	840366	274,95 €
EA-03-12	2700K	360lm	9,0W	840363	324,95 €
EA-03-12	RGB	415lm	17,5W	840367	324,95 €
EV-01-08	2700K	395lm	9,0W	840364	274,95 €
EV-01-08	RGB	445lm	17,5W	840368	274,95 €
EV-02-08	2700K	390lm	9,0W	840365	274,95 €
EV-02-08	RGB	410lm	17,5W	840369	274,95 €
EL-03-12	RGB+2700K	790lm	26,0W	840370	334,95 €
EV-01-12	RGB+2700K	780lm	26,0W	840371	334,95 €
EV-02-12	RGB+2700K	785lm	26,0W	840372	334,95 €

HARD GROUTING – THIS IS HOW IT WORKS

Do you have a heavy-duty application, e.g. walkable or water-protected?

Select the appropriate profile and end caps [if available] for your application. Please make sure that you select a profile that covers the required minimum inner profile width. This ensures that the LED strip is completely enclosed by the potting compound [floating potting, IP68 guaranteed]. The required minimum inner profile width can be found in the table below. After determining your profile and the desired light colour, please also refer to the table for the article number of your hard encapsulation. Smallest possible length 80 mm, longest possible length 3980 mm [depending on the length of the profile]. Tolerance +/- 2mm

You will receive a customised / encapsulated LED stripe in an optionally selected profile with a 3m-feed and open tinned wire ends. Make sure not to deform the encapsulated profile during installation.

inside width	light colour	lm/m	W/m	item	rm. price
11,7 - 21,7mm	3000K	ca. 800lm	14,4W	840380	379,95 €
11,7 - 21,7mm	4000K	ca. 800lm	14,4W	840381	379,95 €
11,7 - 21,7mm	6000K	ca. 800lm	14,4W	840382	379,95 €
11,7 - 21,7mm	3000K-6000K	ca. 2x 600lm	23,0W	840383	419,95 €
11,7 - 21,7mm	RGB	ca. 600lm	14,4W	840384	409,95 €
16,0 - 21,7mm	RGB+3000K	RGB ca. 600lm Weiß ca. 500lm	23,0W	840385	439,95 €

GENERAL INFORMATION

A required potting projection of at least 30 mm is included in the requested dimension. This ensures tightness on the cable side and on the end piece. If a desired dimension is specified for which the potting projection cannot be maintained, the LED stripe is shortened by one segment and conveyed.

The prices quoted are per running metre. Invoicing is per metre or part thereof. Please note that after delivery we cannot accept any liability for further treatment or processing on your part or for positioning and attachment. As this is a custommade product, it cannot be exchanged or returned.

width in mm	voltage [DC]	W / m	type	light colour	colour temperature	lm / m	LED / m	length in mm	protection class	item number	page
4,0	24V	5,5	COB	ww	3000K	855	480	5000	IP20	840327	825
4,0	24V	5,5	COB	nw	4000K	950	480	5000	IP20	840328	825
4,0	24V	11,0	Standard	ww	2700K	995	266	5000	IP20	840175	838
4,0	24V	11,0	Standard	ww	3000K	1090	266	5000	IP20	840210	838
4,0	24V	11,5	Standard	nw	4000K	1100	266	5000	IP20	840267	838
5,0	24V	8,5	Standard	ww	2700K	680	120	5000	IP20	840158	837
5,0	24V	10,5	Standard	ww	3000K	730	120	5000	IP20	840159	837
5,0	24V	11,0	Standard	RGB		500	120	5000	IP20	840276	853
6,5	24V	9,5	D FLEX Side View	ww	3000K	287	120	5000	IP44	840376	875
6,5	24V	10,0	D FLEX Side View	RGB		120	120	5000	IP44	840377	878
7,0	24V	8,0	D FLEX Side View	ww	3000K	295	120	5000	IP68	840283	876
7,0	24V	8,0	D FLEX Side View	RGB		110	120	5000	IP68	840284	879
7,0	24V	12,5	Standard	ww cw	3000-6500K	1070	196	5000	IP67	840349	850
8,0	12V	6,5	Standard	ww	3000K	555	120	5000	IP20	840165	833
8,0	12V	7,0	Standard	ww	2700K	570	120	5000	IP20	840164	833
8,0	12V	7,0	Standard	cw	6500K	630	120	5000	IP20	840167	833
8,0	12V	7,0	Standard	nw	4000K	670	120	5000	IP20	840166	833
8,0	12V	7,0	Standard	nw	4000K	660	120	5000	IP33	840170	833
8,0	12V	10,0	Standard	ww cw	3000-6500K	760	120	5000	IP20	840097	847
8,0	24V	11,0	Standard	ww cw	3000-6500K	1025	196	5000	IP20	840350	849
8,0	24V	13,5	Standard	ww	3000K	1100	180	5000	IP20	840179	838
8,0	24V	13,5	Standard	ww	3000K	1100	180	50000	IP20	930512	838
8,0	24V	13,5	Standard	nw	4000K	1220	180	5000	IP20	840180	838
8,0	24V	13,5	Standard	nw	4000K	1225	180	50000	IP20	930513	838
8,0	24V	14,0	Standard	ww	2700K	1110	180	5000	IP20	840178	838

quick finder sorted in ascending order by width and performance

width in mm	voltage [DC]	W / m	type	light colour	colour temperature	lm / m	LED / m	length in mm	protection class	item number	page
9,5	24V	10,0	D FLEX Top View	RGB		315	120	5000	IP68	840286	871
9,5	24V	10,5	D FLEX Top View	ww	3000K	730	144	5000	IP68	840285	867
10,0	48V	4,0	Standard	ww	3000K	400	78	15000	IP44	840317	844
10,0	48V	4,0	Standard	ww	3000K	405	78	50000	IP44	840338	844
10,0	48V	4,0	Standard	nw	4000K	455	78	15000	IP44	840319	844
10,0	48V	4,0	Standard	nw	4000K	455	78	50000	IP44	840340	844
10,0	48V	4,0	Standard	ww	3000K	485	78	15000	IP20	840318	843
10,0	48V	4,0	Standard	ww	3000K	485	78	50000	IP20	840337	843
10,0	48V	4,0	Standard	nw	4000K	530	78	15000	IP20	840320	843
10,0	48V	4,0	Standard	nw	4000K	530	78	50000	IP20	840339	843
10,0	24V	9,5	Standard	ww	3000K	705	120	10000	IP20	840291	837
10,0	24V	10,5	COB	nw	3000K	900	480	5000	IP20	840330	825
10,0	24V	11,0	COB	ww	3000K	885	480	5000	IP20	840329	825
10,0	24V	10,5	COB	ww cw	2700-6500K	960	576	5000	IP20	840374	829
10,0	12V	10,5	Standard	ww cw	3000-6500K	1025	120	5000	IP20	840142	847
10,0	24V	12,0	COB	nw	4000K	1130	480	5000	IP20	840304	826
10,0	24V	12,5	COB	ww	3000K	1120	480	5000	IP20	840296	826
10,0	24V	13,0	Standard	RGB		580	60	5000	IP20	840254	853
10,0	24V	14,0	Standard	RGB		665	96	5000	IP20	840147	854
10,0	24V	14,5	Standard	RGB		665	96	50000	IP20	930516	854
10,0	24V	16,0	COB	ww	3000K	2230	480	5000	IP20	840323	826
10,0	24V	16,0	COB	nw	4000K	2565	480	5000	IP20	840324	826
10,0	24V	16,0	Standard	RGB ww	3000K	820	60	5000	IP20	840236	857
10,0	24V	16,0	Standard	RGB ww	3000K	820	60	50000	IP20	930517	857
10,0	24V	16,5	Standard	RGB nw	4000K	775	60	5000	IP20	840353	858
10,0	24V	16,5	Standard	RGB nw	4000K	775	60	50000	IP20	840354	858
10,0	24V	16,5	Standard	RGB cw	6500K	795	60	5000	IP20	840356	858

width in mm	voltage [DC]	W / m	type	light colour	colour temperature	lm / m	LED / m	length in mm	protection class	item number	page
10,0	24V	16,5	COB	RGB		660	840	5000	IP20	840375	831
10,0	24V	16,0	Standard	RGB NW	4000K	765	60	5000	IP44	840373	859
10,0	24V	16,5	Standard	RGB CW	6500K	840	60	5000	IP44	840357	859
10,0	48V	19,0	Standard	NW	4000K	1755	700	5000	IP20	840346	843
10,0	48V	19,0	Standard	WW	3000K	1645	700	5000	IP20	840344	843
10,0	24V	18,5	Standard	WW	2700K	1215	240	5000	IP20	840192	839
10,0	24V	19,0	Standard	WW	3000K	1605	240	5000	IP20	840193	839
10,0	24V	19,0	Standard	WW	3000K	1605	240	50000	IP20	930514	839
10,0	24V	20,0	Standard	NW	4000K	1770	240	5000	IP20	840194	839
10,0	24V	20,0	Standard	NW	4000K	1770	240	50000	IP20	930515	839
10,0	24V	19,0	Standard	WW	3000K	1625	120	5000	IP20	840325	839
10,0	24V	19,0	Standard	WW	3000K	1740	120	50000	IP20	840335	839
10,0	24V	19,0	Standard	NW	4000K	1560	120	5000	IP20	840326	839
10,0	24V	19,5	Standard	NW	4000K	1560	120	50000	IP20	840336	839
10,0	24V	20,0	Standard	CW	6000K	1720	120	5000	IP20	840124	840
10,0	24V	21,0	Standard	WW	3000K	1595	120	5000	IP20	840122	840
10,0	24V	22,5	Standard	WW	3000K	2520	160	5000	IP44	840333	841
10,0	24V	22,5	Standard	NW	4000K	2555	160	5000	IP44	840334	841
10,0	24V	22,5	Standard	WW CW	2700-6500K	1765	120	5000	IP20	840348	849
10,0	24V	22,5	Standard	NW	4000K	2815	160	5000	IP20	840332	840
10,0	24V	22,5	Standard	WW	3000K	2570	160	5000	IP20	840331	840
10,0	24V	23,5	Standard	WW CW	2700-6500K	1565	120	5000	IP44	840347	850
10,5	12V	7,0	Standard	WW	2700K	550	120	5000	IP67	840172	834
10,5	24V	11,5	Standard	WW	2700K	900	180	5000	IP67	840186	841
10,5	24V	11,0	Standard	WW	3000K	930	180	5000	IP67	840187	841
12,0	24V	10,5	D FLEX Side View	WW	3000K	368	144	5000	IP68	840287	877
12,0	24V	10,5	D FLEX Side View	RGB WW	3200K	210	84	5000	IP68	840290	881

quick finder sorted in ascending order by width and performance

width in mm	voltage [DC]	W / m	type	light colour	colour temperature	lm / m	LED / m	length in mm	protection class	item number	page
12,0	24V	14,0	Standard		3000K	585	96	5000	IP20	840144	857
12,0	48V	20,0	Standard		4000K	1705	700	5000	IP67	840345	844
12,0	48V	21,0	Standard		3000K	1680	700	5000	IP67	840343	844
12,0	24V	22,0	Standard		3000K	955	192	5000	IP20	840308	858
12,0	24V	22,0	Standard		4000K	985	192	5000	IP20	840309	858
12,0	24V	27,5	Standard			1045	120	5000	IP44	840351	855
12,0	24V	28,0	Standard			1055	120	5000	IP20	840352	854
12,5	24V	12,5	Standard			530	60	5000	IP67	840256	855
12,5	24V	15,0	COB		3000K	2225	480	5000	IP67	840321	827
12,5	24V	15,0	COB		4000K	2455	480	5000	IP67	840322	827
12,5	24V	15,0	Standard		3000K	735	60	5000	IP67	840239	859
15,0	24V	15,5	Standard		2700-6500K	1035	72	5000	IP20	840359	860
15,0	24V	15,5	Standard		2700-6500K	1035	72	50000	IP20	840360	860
15,0	230V	18,0	Standard		3000K	1580	120	15000	IP65	840310	883
15,0	230V	18,0	Standard		3000K	1580	120	50000	IP65	840311	883
15,0	230V	19,0	Standard		4000K	1695	120	15000	IP65	840312	883
15,0	230V	19,0	Standard		4000K	1695	120	50000	IP65	840313	883
16,0	24V	10,5	D FLEX Top View		3200K	320	84	5000	IP68	840289	873
16,5	24V	10,5	D FLEX Top View		3000K	515	144	5000	IP68	840288	869
17,0	24V	15,5	Standard		2700-6500K	960	72	5000	IP67	840358	861
20,0	24V	13,5	D LENSE LINE		3000K	1490	210	5000	IP67	840297	863
20,0	24V	13,5	D LENSE LINE		3000K	1320	210	5000	IP67	840298	863
21,0	24V	8,0	D LENSE LINE			295	210	5000	IP67	840299	865
21,0	24V	8,0	D LENSE LINE			320	210	5000	IP67	840300	865

COB | 1CH | 24V

COB stripes in warm white 3000K und neutral white 4000K
These LED stripes are ideal when the focus is on a homogeneous light pattern.



COB-480-24V-3000K / 4000K-5M

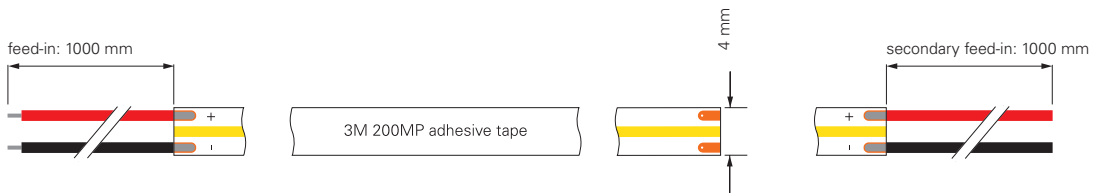
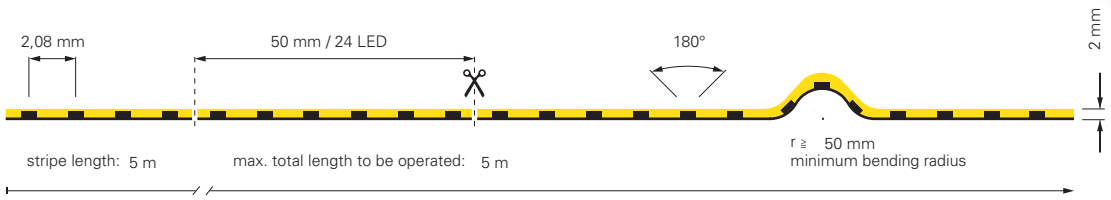

840327	5 m roll	WW	3000K [+/- 150K]	480 LED/m	5,5 W/m	155,45 lm/W	855 lm/m	149,95 €
840328	5 m roll	NW	4000K [+/- 150K]	480 LED/m	5,5 W/m	172,73 lm/W	950 lm/m	149,95 €

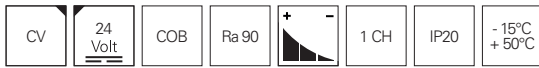

COB-480-24V-3000K / 4000K-5M

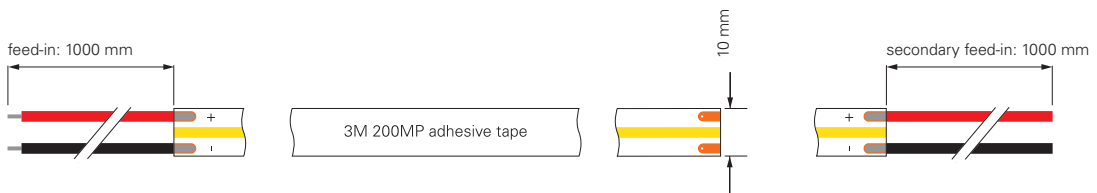
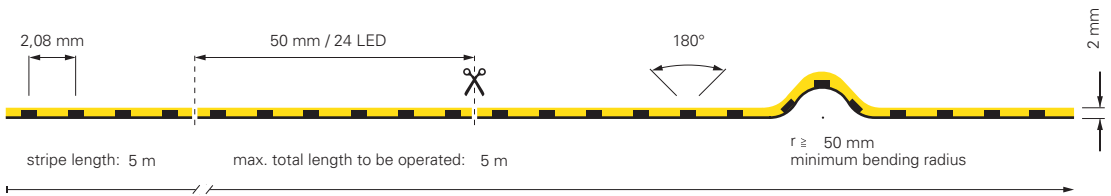

840329	5 m roll	WW	3000K [+/- 150K]	480 LED/m	11,0 W/m	80,45 lm/W	855 lm/m	159,95 €
840330	5 m roll	NW	4000K [+/- 150K]	480 LED/m	10,5 W/m	85,71 lm/W	900 lm/m	159,95 €

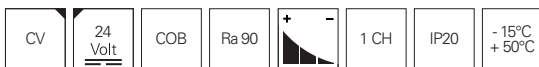

COB-480-24V-3000K / 4000K-5M

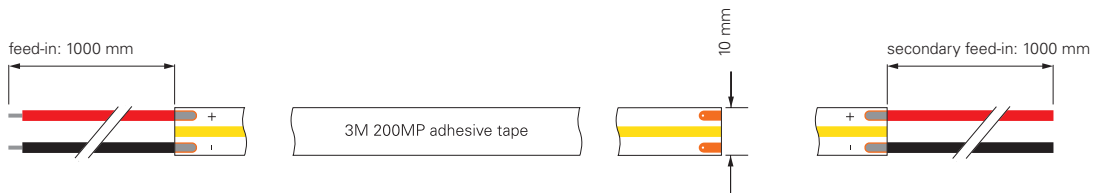
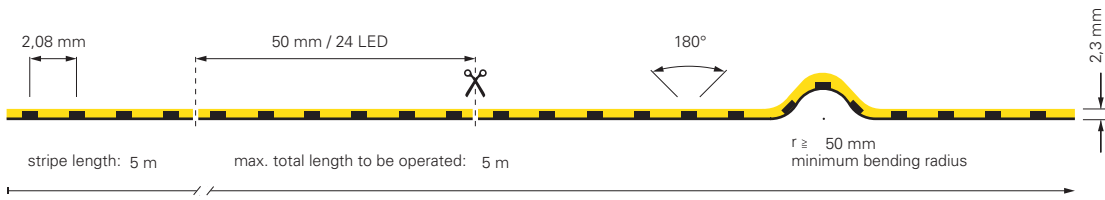

840296	5 m roll	WW	3000K [± 150K]	480 LED/m	12,5 W/m	89,60 lm/W	1120 lm/m	154,95 €
840304	5 m roll	NW	4000K [± 150K]	480 LED/m	12,0 W/m	94,17 lm/W	1130 lm/m	154,95 €



COB-480-24V-3000K / 4000K-5M

new

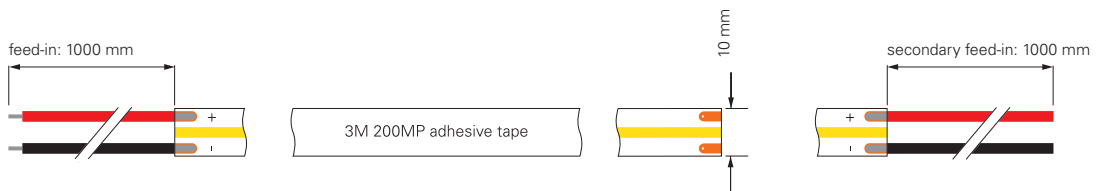
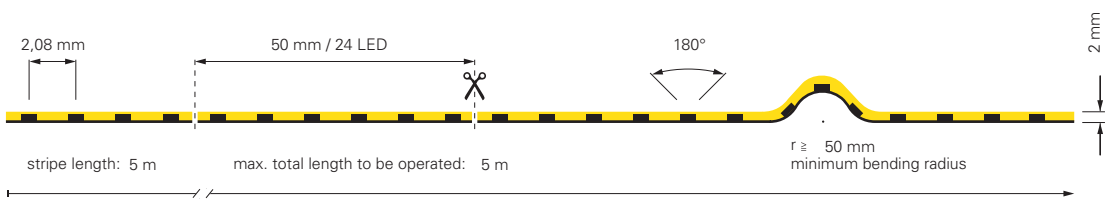

840323	5 m roll	WW	3000K [± 150K]	480 LED/m	16 W/m	139,38 lm/W	2230 lm/m	179,95 €
840324	5 m roll	NW	4000K [± 150K]	480 LED/m	16 W/m	160,31 lm/W	2565 lm/m	179,95 €



COB-480-24V-3000K / 4000K-5M-SILIKON

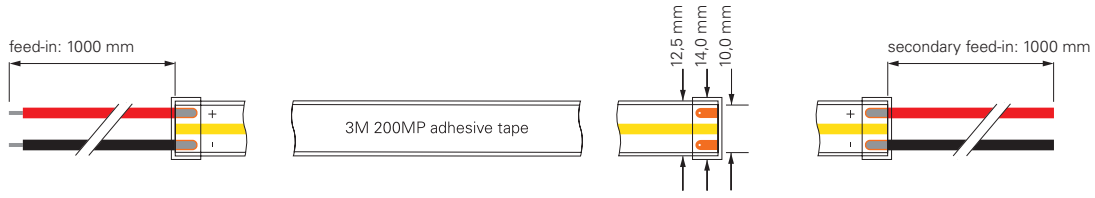
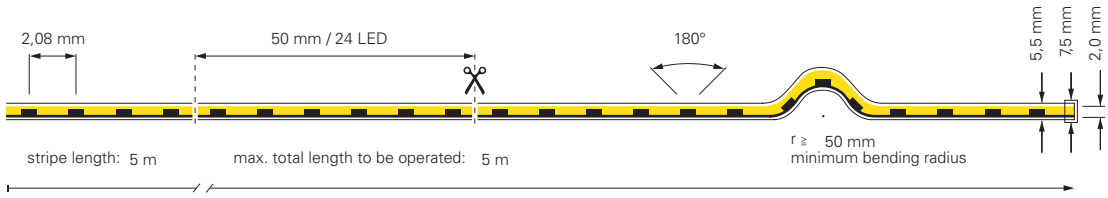

840321	5 m roll	3000K [± 150K]	480 LED/m	15 W/m	148,33 lm/W	2225 lm/m	199,95 €
840322	5 m roll	4000K [± 150K]	480 LED/m	15 W/m	163,67 lm/W	2455 lm/m	199,95 €

CV

24 Volt

COB

Ra 90

1 CH

IP67

-15°C
+50°C

incl. accessories: 10x retaining bracket, 20x stainless steel screw, 2x endcap

COB | 2CH | 24V

COB stripe in warm white 2700K – cold white 6500K
These LED stripes are ideal when the focus is on a homogeneous light pattern. With these COB stripes, you have the option of mixing white tones between 2700K and 6500K through flexible control.





COB-576-24V-2700-6500K-5M

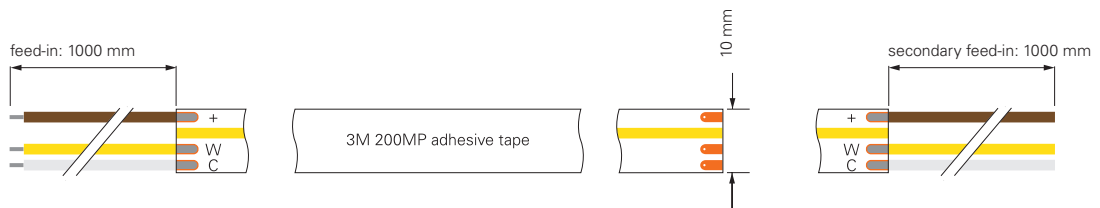
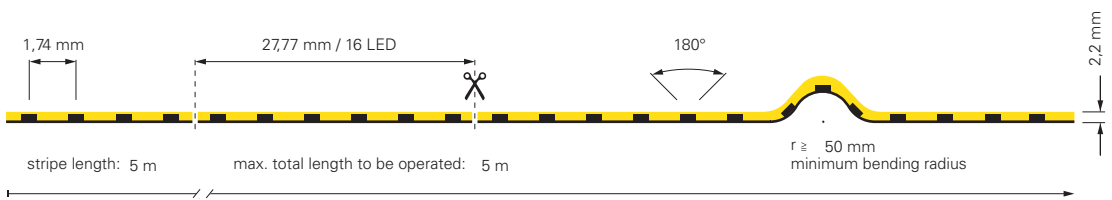

840374 5 m roll ww cw 2700-6500K [+/- 150K] 576 LED/m 10,5 W/m 91,43 lm/W 960 lm/m **299,95 €**



COB | 3CH | 24V

COB stripe in RGB

These LED stripes are ideal when the focus is on a homogeneous light pattern. With these COB stripes, you have the option of setting individual colours or mixed colours as desired through flexible control.



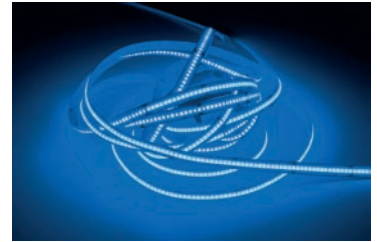
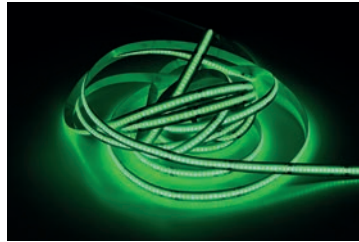
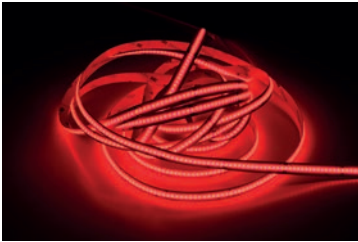

COB-840-24V-RGB-5M

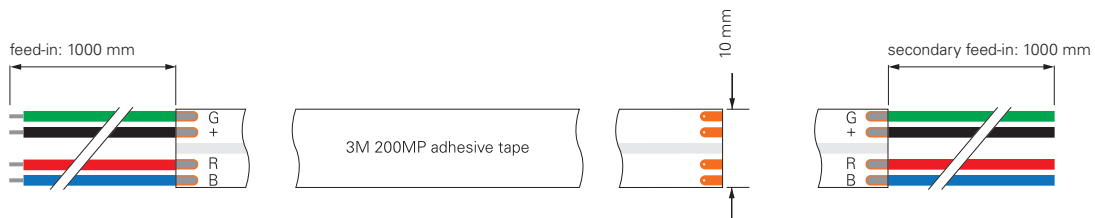
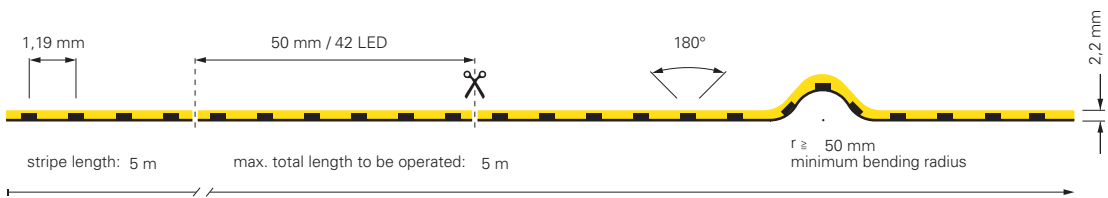

840375 5 m roll  460-620 nm 840 LED/m 16,5 W/m 40 lm/W 660 lm/m **399,95 €**

CV	24 Volt	COB		3 CH	IP20	-15°C +50°C
----	---------	-----	---	------	------	----------------

STANDARD | 1CH | 12V

LED stripes in warm white 2700K + 3000K, neutral white 4000K and cold white 6500K
These LED stripes are ideally suited for all standard applications and special assemblies with the most diverse requirements. With voltages of 12V, different protection classes, lumens, number of LEDs, power and much more, you will find the right LED stripe for your application.



3528-120-12V-2700K / 3000K / 4000K / 6500K-5M

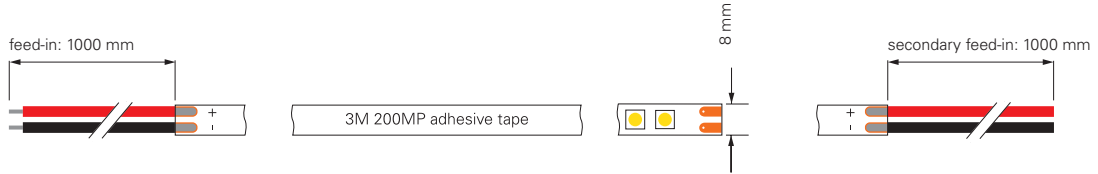
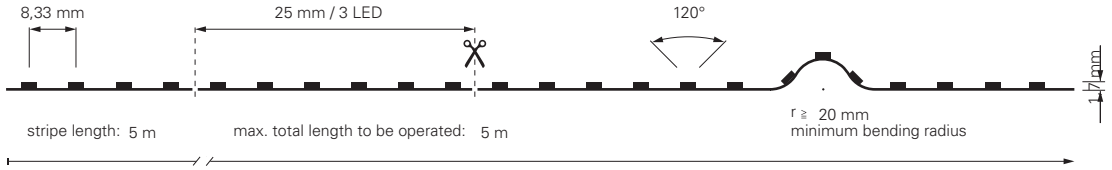

840164	5 m roll	WW	2700K [+/- 150K]	120 LED/m	7,0 W/m	81,43 lm/W	570 lm/m	89,95 €
840165	5 m roll	WW	3000K [+/- 150K]	120 LED/m	6,5 W/m	85,38 lm/W	555 lm/m	89,95 €
840166	5 m roll	NW	4000K [+/- 150K]	120 LED/m	7,0 W/m	95,71 lm/W	670 lm/m	89,95 €
840167	5 m roll	CW	6500K [+/- 150K]	120 LED/m	7,0 W/m	90,00 lm/W	630 lm/m	89,95 €



3528-120-12V-4000K-5M-NANO

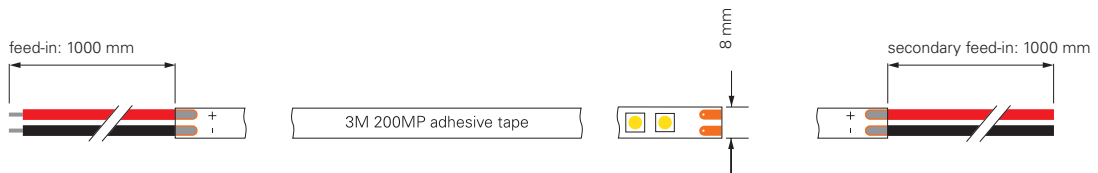
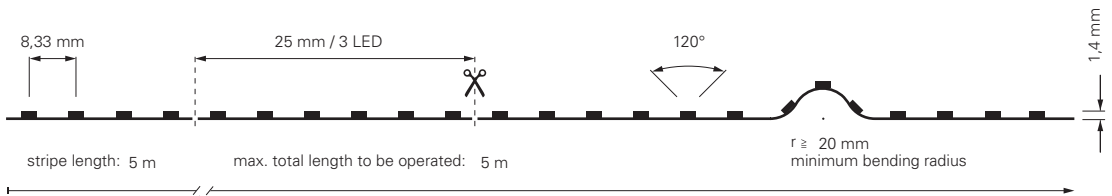

840170	5 m roll	NW	4000K [+/- 150K]	120 LED/m	7 W/m	94,29 lm/W	660 lm/m	119,95 €
---------------	----------	----	------------------	-----------	-------	------------	----------	-----------------



3528-120-12V-2700K-5M-SILIKON

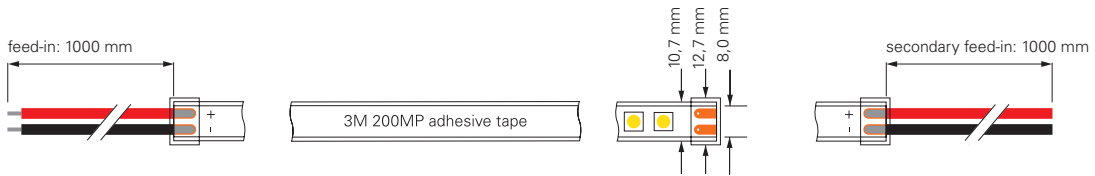
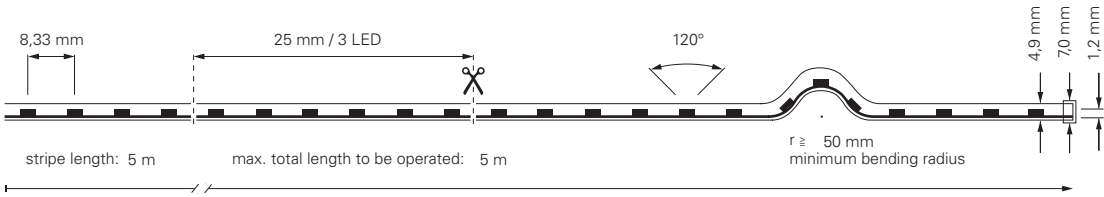

840172 5 m roll  2700K [+/- 150K] 120 LED/m 7 W/m 78,57 lm/W 550 lm/m **149,95 €**



incl. accessories: 10x retaining bracket, 20x stainless steel screw, 2x endcap



STANDARD | 1CH | 24V

LED stripes in warm white 2700K + 3000K, neutral white 4000K and cold white 6500K
These LED stripes are ideally suited for all standard applications and special assemblies with the most diverse requirements. With voltages of 24V, different protection classes, lumens, number of LEDs, power and much more, you will find the right LED stripe for your application.



3528-120-24V-2700K / 3000K-5M

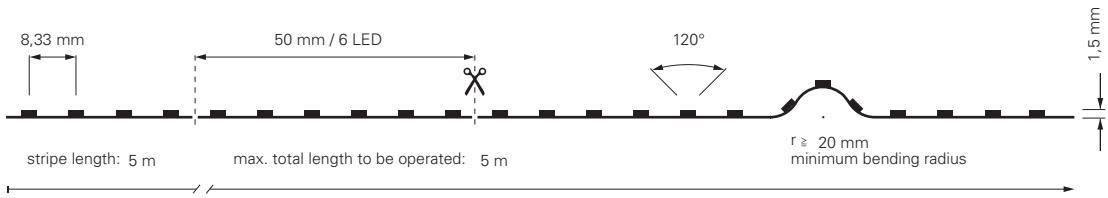

840158	5 m roll	2700K [+/- 150K]	120 LED/m	8,5 W/m	80,00 lm/W	680 lm/m	79,95 €
840159	5 m roll	3000K [+/- 150K]	120 LED/m	10,5 W/m	69,52 lm/W	730 lm/m	79,95 €

CV	24 Volt	SMD 3528	Ra 90		1 CH	IP20	-15°C +50°C
----	---------	----------	-------	--	------	------	----------------

2835-120-24V-3000K-10M

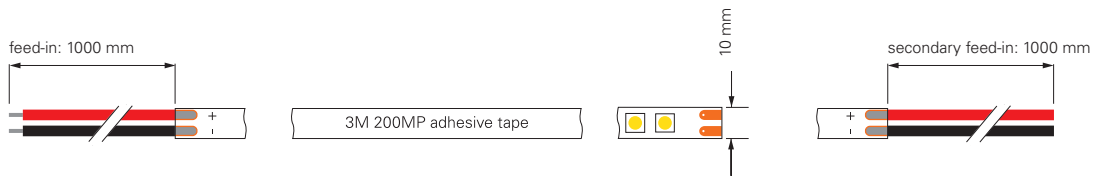
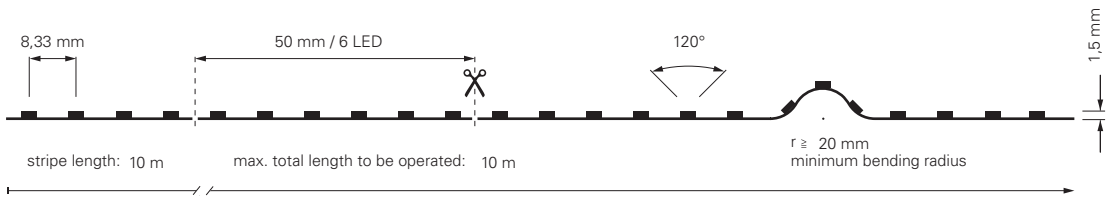

840291	10 m roll	3000K [+/- 150K]	120 LED/m	9,5 W/m	74,21 lm/W	705 lm/m	399,95 €
---------------	-----------	------------------	-----------	---------	------------	----------	-----------------

CV	24 Volt	SMD 2835	Ra 90		1 CH	IP20	-15°C +50°C
----	---------	----------	-------	--	------	------	----------------

2216-266-24V-2700K / 3000K / 4000K-5M

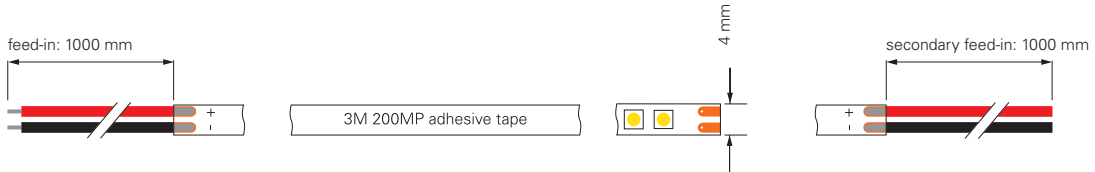
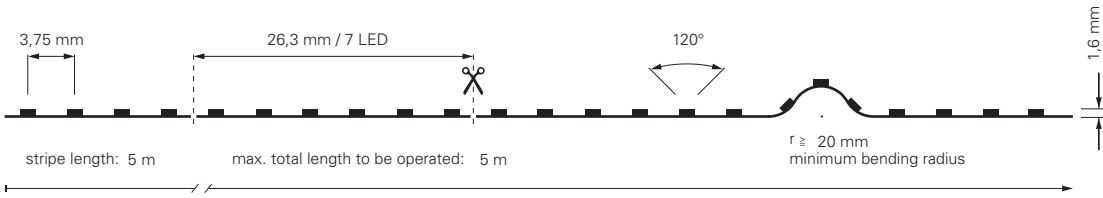

840175	5 m roll	WW	2700K [+/- 150K]	266 LED/m	11,0 W/m	90,45 lm/W	995 lm/m	169,95 €
840210	5 m roll	WW	3000K [+/- 150K]	266 LED/m	11,0 W/m	99,09 lm/W	1090 lm/m	169,95 €
840267	5 m roll	NW	4000K [+/- 150K]	266 LED/m	11,5 W/m	95,65 lm/W	1100 lm/m	169,95 €



3528-180-24V-3000K-5M / 3000K-50M / 2700K-5M / 4000K-5M / 4000K-50M

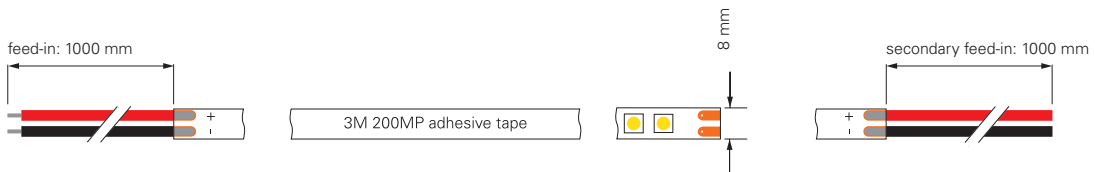
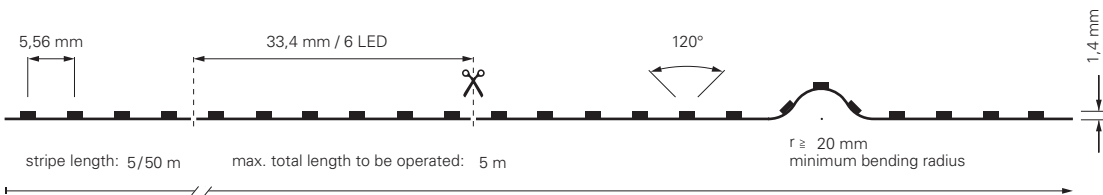

840179	5 m roll	WW	3000K [+/- 150K]	180 LED/m	13,5 W/m	81,48 lm/W	1100 lm/m	129,95 €
930512	50 m roll	WW	3000K [+/- 150K]	180 LED/m	13,5 W/m	81,48 lm/W	1100 lm/m	1199,95 €
840178	5 m roll	WW	2700K [+/- 150K]	180 LED/m	14,0 W/m	79,29 lm/W	1110 lm/m	129,95 €
840180	5 m roll	NW	4000K [+/- 150K]	180 LED/m	13,5 W/m	90,37 lm/W	1220 lm/m	129,95 €
930513	50 m roll	NW	4000K [+/- 150K]	180 LED/m	13,5 W/m	90,74 lm/W	1225 lm/m	1199,95 €



3528-240-24V-2700K-5M / 3000K-5M / 3000K-50M / 4000K-5M / 4000K-50M

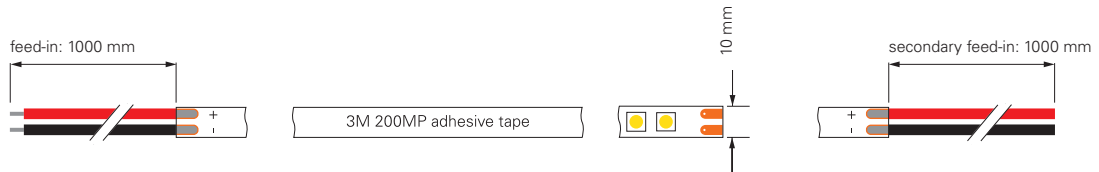
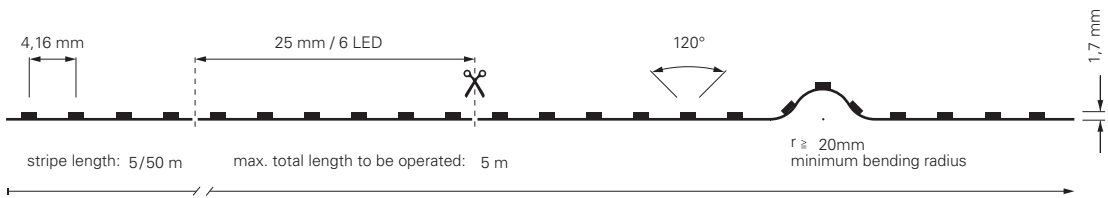

840192	5 m roll	WW	2700K [+/- 150K]	240 LED/m	18,5 W/m	65,68 lm/W	1215 lm/m	169,95 €
840193	5 m roll	WW	3000K [+/- 150K]	240 LED/m	19,0 W/m	84,47 lm/W	1605 lm/m	169,95 €
930514	50 m roll	WW	3000K [+/- 150K]	240 LED/m	19,0 W/m	84,47 lm/W	1605 lm/m	1499,95 €
840194	5 m roll	NW	4000K [+/- 150K]	240 LED/m	20,0 W/m	88,50 lm/W	1770 lm/m	169,95 €
930515	50 m roll	NW	4000K [+/- 150K]	240 LED/m	20,0 W/m	88,50 lm/W	1770 lm/m	1499,95 €



2835-120-24V-3000K-5M / 3000K-50M / 4000K-5M / 4000K-50M

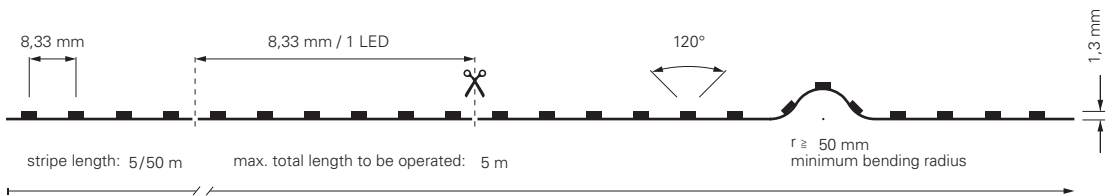

840325	5 m roll	WW	3000K [+/- 150K]	120 LED/m	19,0 W/m	85,53 lm/W	1625 lm/m	169,95 €
840335	50 m roll	WW	3000K [+/- 150K]	120 LED/m	19,0 W/m	91,58 lm/W	1740 lm/m	1599,95 €
840326	5 m roll	NW	4000K [+/- 150K]	120 LED/m	19,0 W/m	82,11 lm/W	1560 lm/m	169,95 €
840336	50 m roll	NW	4000K [+/- 150K]	120 LED/m	19,5 W/m	80,00 lm/W	1560 lm/m	1599,95 €



2835-120-24V-3000K / 6000K-5M

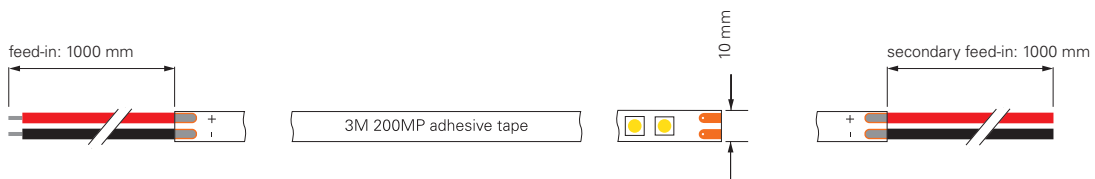
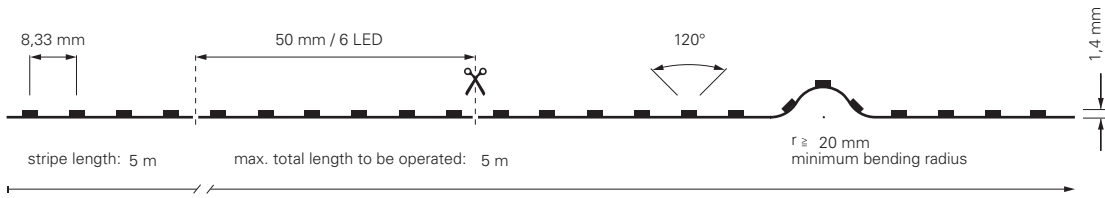

840122	5 m roll	ww	3000K [+/- 150K]	120 LED/m	21 W/m	75,95 lm/W	1595 lm/m	199,95 €
840124	5 m roll	cw	6000K [+/- 150K]	120 LED/m	20 W/m	86,00 lm/W	1720 lm/m	199,95 €



2835-160-24V-3000K / 4000K-5M

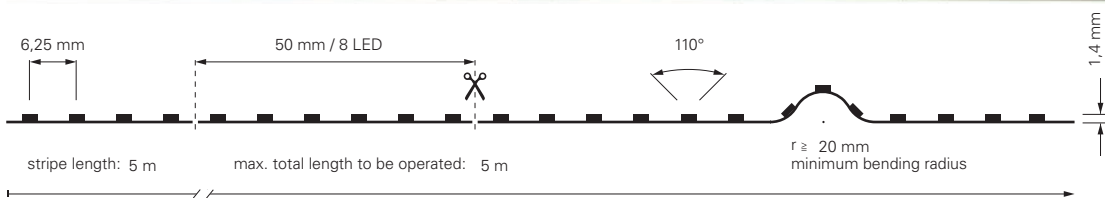

840331	5 m roll	ww	3000K [+/- 150K]	160 LED/m	22,5 W/m	114,22 lm/W	2570 lm/m	249,95 €
840332	5 m roll	nw	4000K [+/- 150K]	160 LED/m	22,5 W/m	125,11 lm/W	2815 lm/m	249,95 €



2835-160-24V-3000K / 4000K-5M-SILIKON

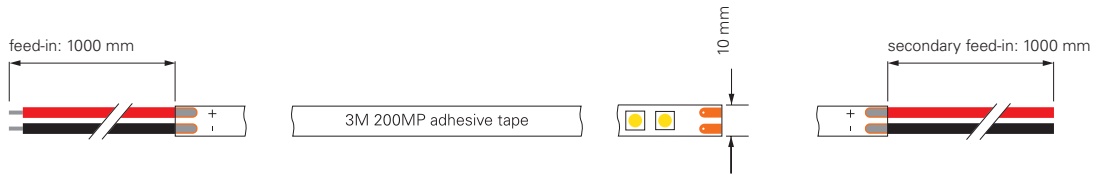
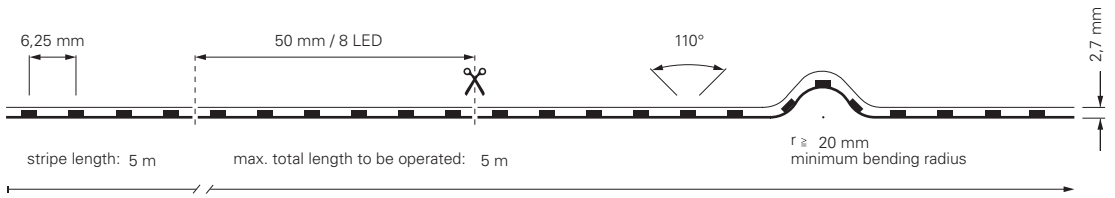

840333	5 m roll	3000K [+/- 150K]	160 LED/m	22,5 W/m	112,00 lm/W	2520 lm/m	269,95 €
840334	5 m roll	4000K [+/- 150K]	160 LED/m	22,5 W/m	113,56 lm/W	2555 lm/m	269,95 €

CV	24 Volt	SMD 2835	Ra 90		1 CH	IP44	-15°C +50°C
----	---------	----------	-------	--	------	------	----------------

3528-180-24V-2700K / 3000K-5M-SILIKON

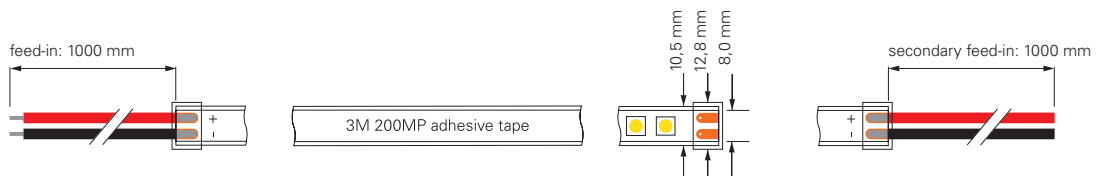
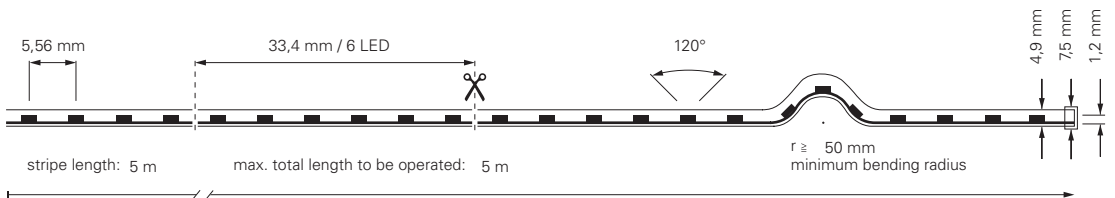

840186	5 m roll	2700K [+/- 150K]	180 LED/m	11,5 W/m	78,26 lm/W	900 lm/m	189,95 €
840187	5 m roll	3000K [+/- 150K]	180 LED/m	11,0 W/m	84,55 lm/W	930 lm/m	189,95 €

CV	24 Volt	SMD 3528	Ra 90		1 CH	IP67	-15°C +50°C
----	---------	----------	-------	--	------	------	----------------

incl. accessories: 10x retaining bracket, 20x stainless steel screw, 2x endcap

STANDARD | 1CH | 48V

48V LED stripes in warm white 3000K, neutral white 4000K
These LED stripes are ideally suited when the focus is on long distances to be illuminated. Due to the voltage of 48V, distances of up to 50m can be operated at a stretch.



2835-78-48V-3000K-15M / 3000K-50M / 4000K-15M / 4000K-50M

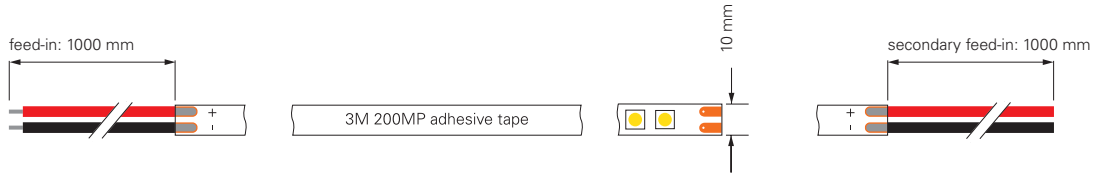
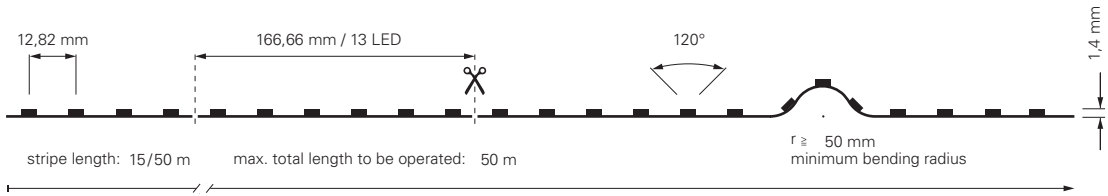

840318	15 m roll	WW	3000K [+/- 150K]	78 LED/m	4 W/m	121,25 lm/W	485 lm/m	449,95 €
840337	50 m roll	WW	3000K [+/- 150K]	78 LED/m	4 W/m	121,25 lm/W	485 lm/m	1399,95 €
840320	15 m roll	NW	4000K [+/- 150K]	78 LED/m	4 W/m	132,50 lm/W	530 lm/m	449,95 €
840339	50 m roll	NW	4000K [+/- 150K]	78 LED/m	4 W/m	132,50 lm/W	530 lm/m	1399,95 €



1808-700-48V-3000K / 4000K-5M

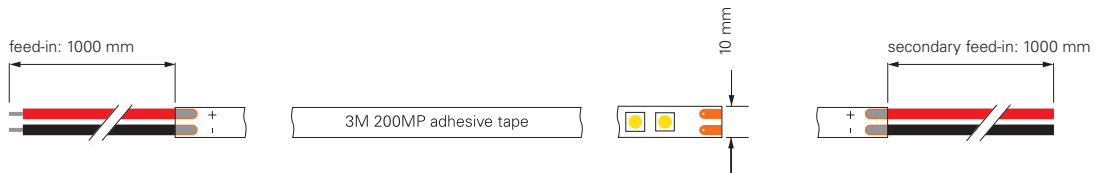
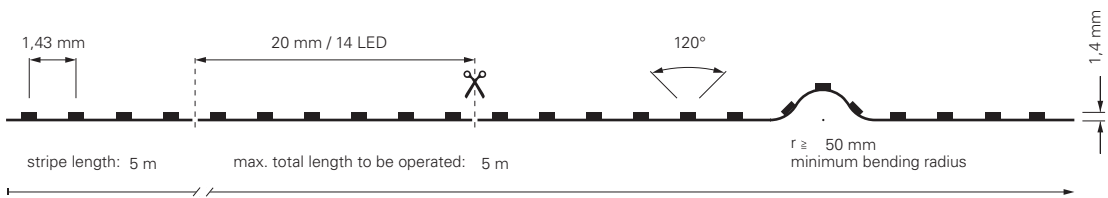

840344	5 m roll	WW	3000K [+/- 150K]	700 LED/m	19 W/m	86,58 lm/W	1645 lm/m	279,95 €
840346	5 m roll	NW	4000K [+/- 150K]	700 LED/m	19 W/m	92,37 lm/W	1755 lm/m	279,95 €



2835-78-48V-3000K-15M / 3000K-50M / 4000K-15M / 4000K-50M-SILIKON

new

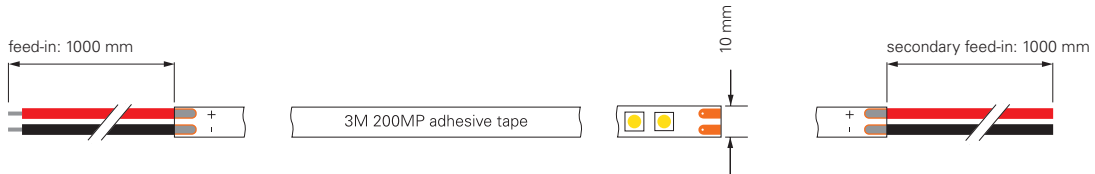
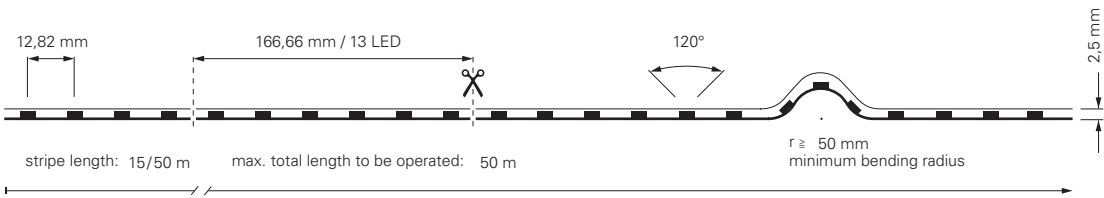

840317	15 m roll	WW	3000K [+/- 150K]	78 LED/m	4 W/m	100,00 lm/W	400 lm/m	499,95 €
840338	50 m roll	WW	3000K [+/- 150K]	78 LED/m	4 W/m	101,25 lm/W	405 lm/m	1599,95 €
840319	15 m roll	NW	4000K [+/- 150K]	78 LED/m	4 W/m	113,75 lm/W	455 lm/m	499,95 €
840340	50 m roll	NW	4000K [+/- 150K]	78 LED/m	4 W/m	113,75 lm/W	455 lm/m	1599,95 €



1808-700-48V-3000K / 4000K-5M-SILIKON

new

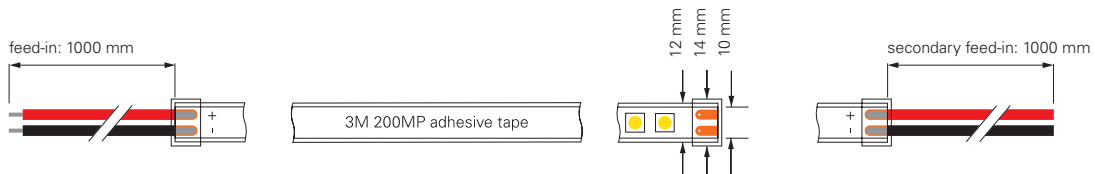
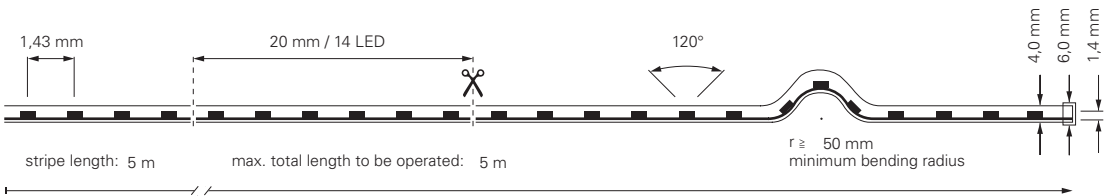

840343	5 m roll	WW	3000K [+/- 150K]	700 LED/m	21 W/m	80,00 lm/W	1680 lm/m	299,95 €
840345	5 m roll	NW	4000K [+/- 150K]	700 LED/m	20 W/m	85,25 lm/W	1705 lm/m	299,95 €

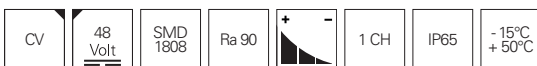

incl. accessories: 10x retaining bracket, 20x stainless steel screw, 2x endcap

With the kind support of BEST Bellemann Elektro Service Team GmbH, Rauenberg-Malschenberg

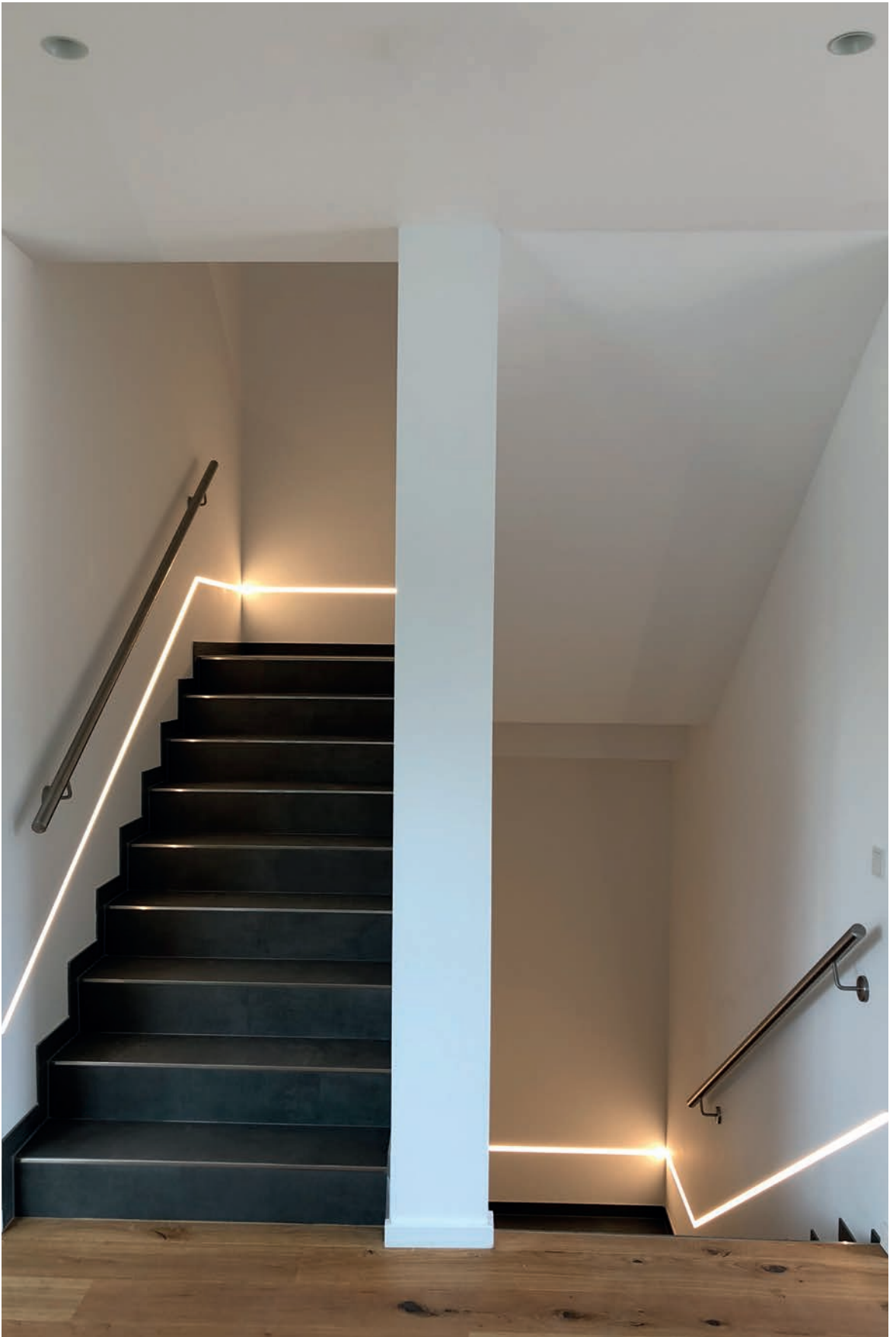

STANDARD | 2CH | 12V

standard stripes in warm white 2700K - cold white 6500K,
warm white 3000K - cold white 6500K
With these standard stripes you have the possibility to mix
white tones between 2700K and 6500K / 3000K and 6500K
through a flexible control.



3528-120-12V-3000K+6500K-5M

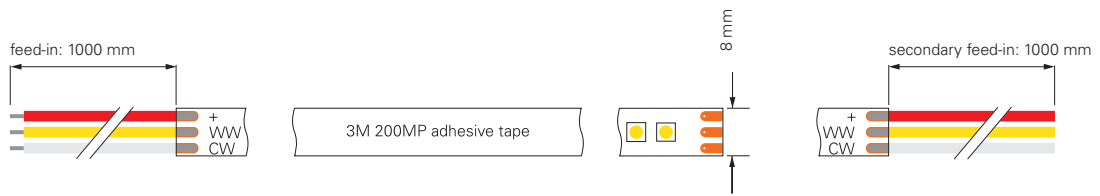
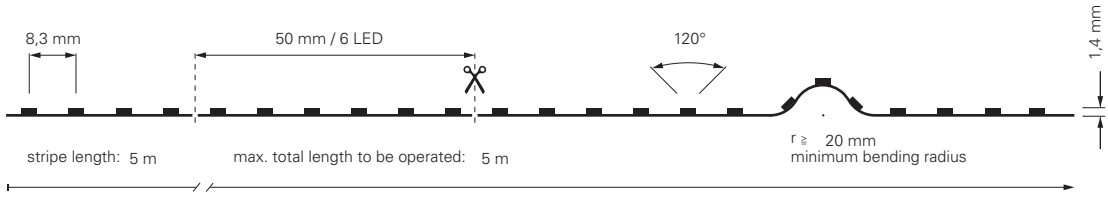

840097 5 m roll ■ ■ 3000-6500K [+/- 150K] 120 LED/m 10 W/m 76 lm/W 760 lm/m **123,95 €**



3528-120-12V-3000K-6500K-5M

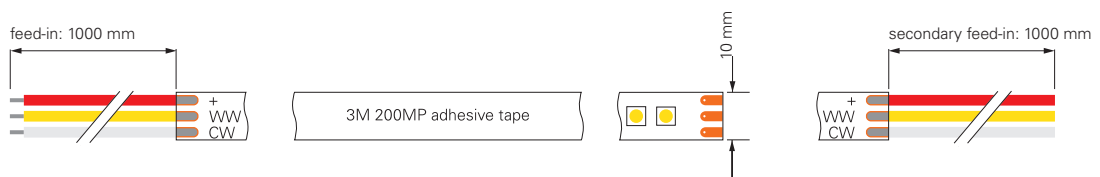
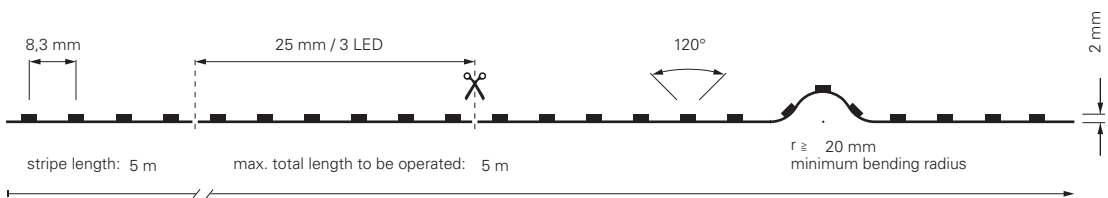

840142 5 m roll ■ ■ 3000-6500K [+/- 150K] 120 LED/m 10,5 W/m 97,62 lm/W 1025 lm/m **199,95 €**



STANDARD | 2CH | 24V

standard stripes in warm white 2700K - cold white 6500K,
warm white 3000K - cold white 6500K

These LED stripes are ideally suited for all standard applications and special assemblies with the most diverse requirements. With these standard stripes, you have the option of mixing white tones between 2700K and 6500K /3000K and 6500K through flexible control.



2216-196-24V-3000-6500K-5M

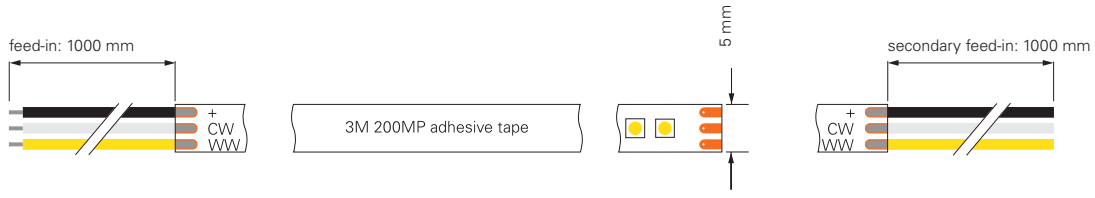
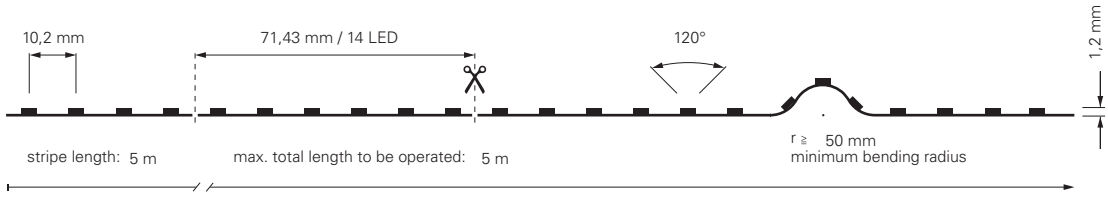

840350 5 m roll ww cw 3000-6500K [+/- 150K] 196 LED/m 11 W/m 93,18 lm/W 1025 lm/m **129,95 €**

CV	24 Volt	SMD 2216	Ra 90		IP20	-15°C +50°C
----	---------	----------	-------	--	------	----------------

2835-120-24V-2700-6500K-5M

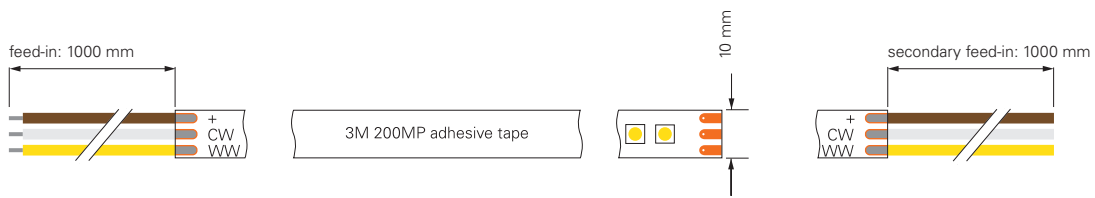
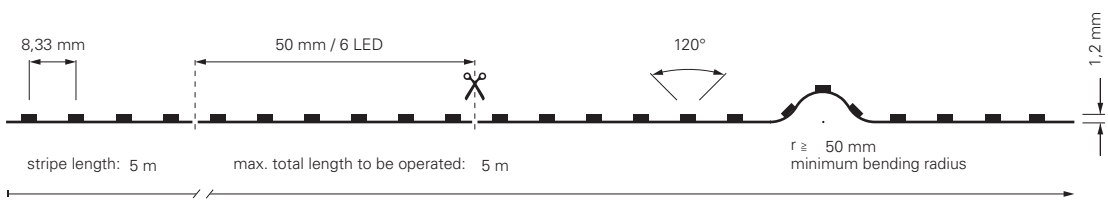

840348 5 m roll ww cw 2700-6500K [+/- 150K] 120 LED/m 22,5 W/m 78,44 lm/W 1765 lm/m **199,95 €**

CV	24 Volt	SMD 2835	Ra 90		IP20	-15°C +50°C
----	---------	----------	-------	--	------	----------------

2835-120-24V-2700-6500K-5M-SILIKON

new

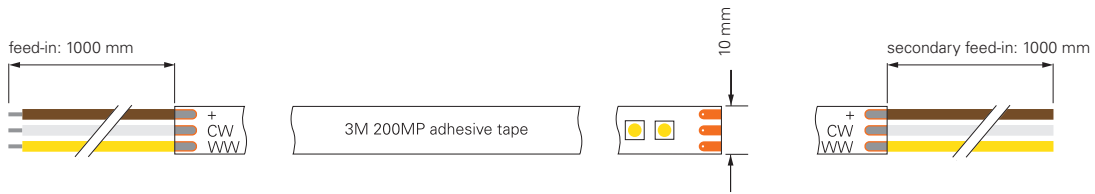
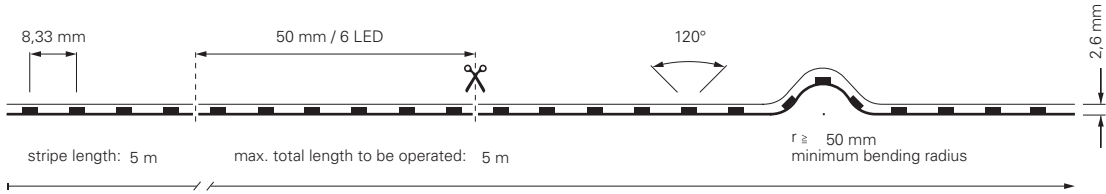

840347 5 m roll ww cw 2700-6500K [±150K] 120 LED/m 23,5 W/m 66,6 lm/W 1565 lm/m **219,95 €**



2216-196-24V-3000-6500K-5M-SILIKON

new

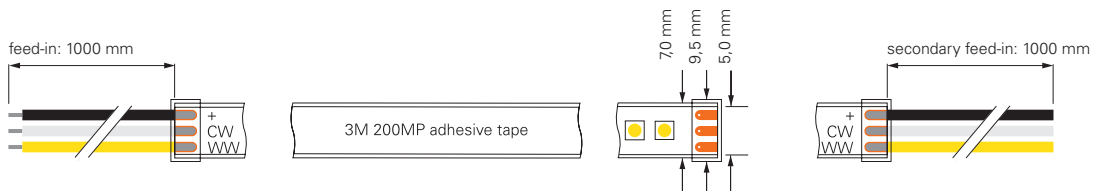
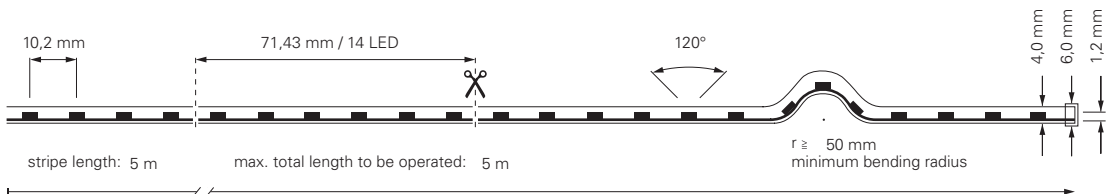

840349 5 m roll ww cw 3000-6500K [±150K] 196 LED/m 12,5 W/m 85,6 lm/W 1070 lm/m **149,95 €**



incl. accessories: 10x retaining bracket, 20x stainless steel screw, 2x endcap



STANDARD | 3CH | 24V

These LED stripes in RGB are ideally suited for all standard applications and special assemblies with the most diverse requirements. With these standard stripes, you have the option of setting individual colours or flexible control to set individual colours or mixed colours as desired.



3535-120-24V-RGB-5M

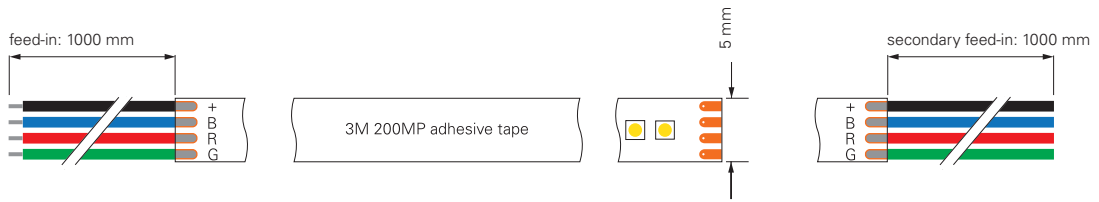
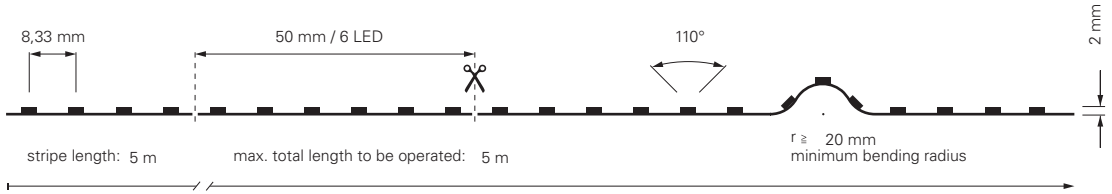

840276 5 m roll  470-630 nm 120 LED/m 11 W/m 45,45 lm/W 500 lm/m **109,95 €**

CV	24 Volt	SMD 3535		3 CH	IP20	-15°C +50°C
----	---------	----------	---	------	------	----------------

5050-60-24V-RGB-5M

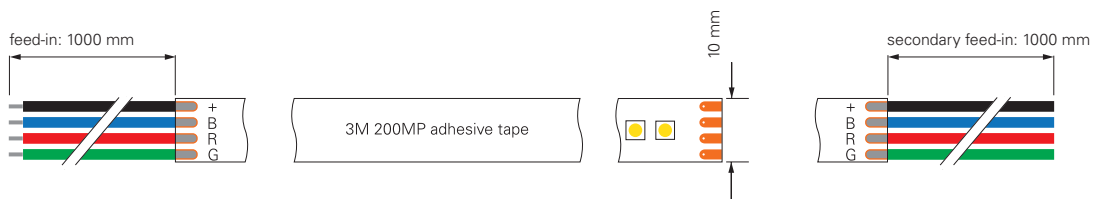
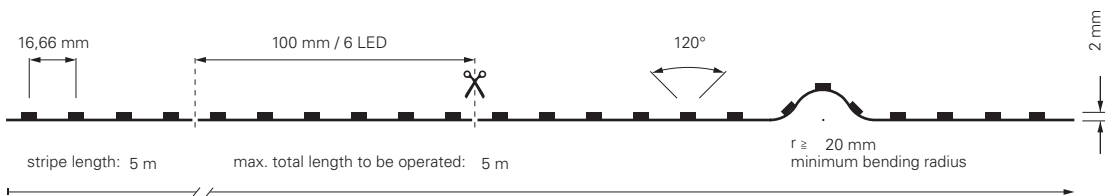

840254 5 m roll  470-630 nm 60 LED/m 13 W/m 45 lm/W 580 lm/m **134,95 €**

CV	24 Volt	SMD 5050		3 CH	IP20	-15°C +50°C
----	---------	----------	---	------	------	----------------

5050-96-24V-RGB-5M / RGB-50M

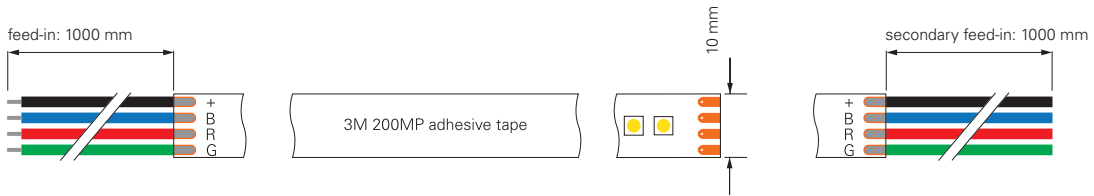
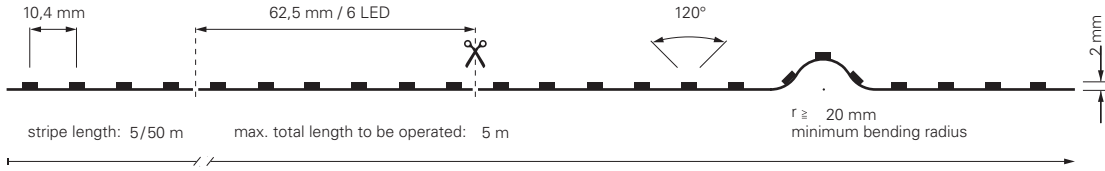

840147	5 m roll		450-630 nm	96 LED/m	14,0 W/m	47,50 lm/W	665 lm/m	173,95 €
930516	50 m roll		450-630 nm	96 LED/m	14,5 W/m	45,86 lm/W	665 lm/m	1599,95 €



5050-120-24V-RGB-5M

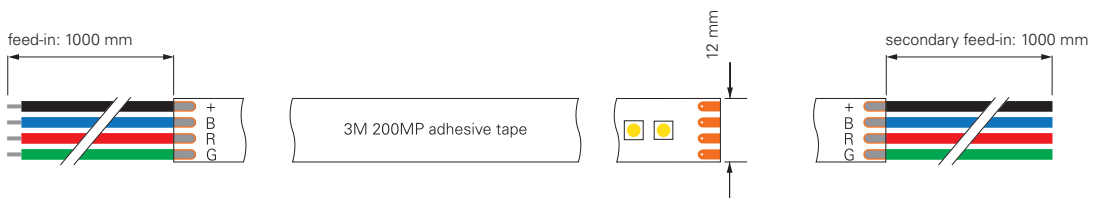
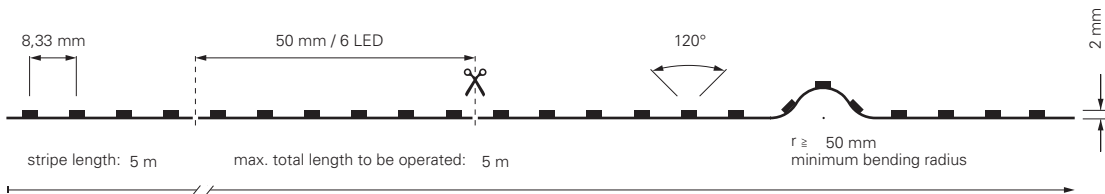

840352	5 m roll		460-620 nm	120 LED/m	28 W/m	37,68 lm/W	1055 lm/m	189,95 €
---------------	----------	--	------------	-----------	--------	------------	-----------	-----------------





5050-120-24V-RGB-5M-SILIKON

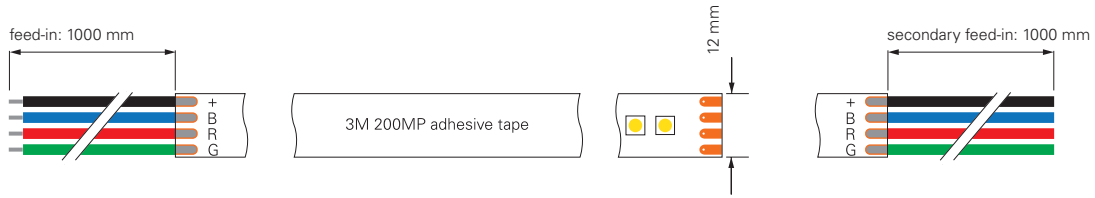
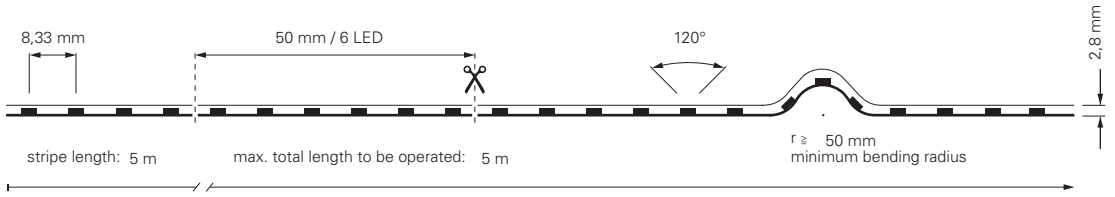

840351 5 m roll 460-620 nm 120 LED/m 27,5 W/m 38 lm/W 1045 lm/m **209,95 €**

CV	24 Volt	SMD 5050		3 CH	IP44	-15°C +50°C
----	---------	----------	--	------	------	----------------

5050-60-24V-RGB-5M-SILIKON

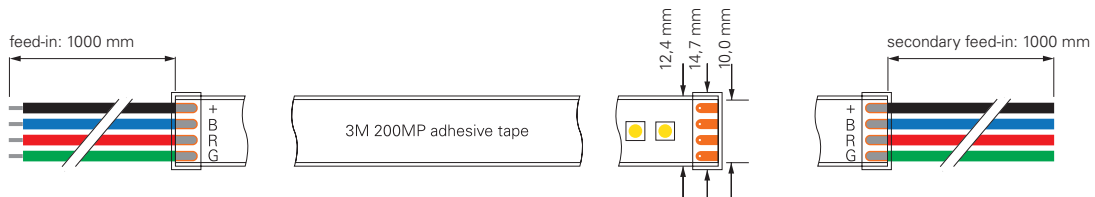
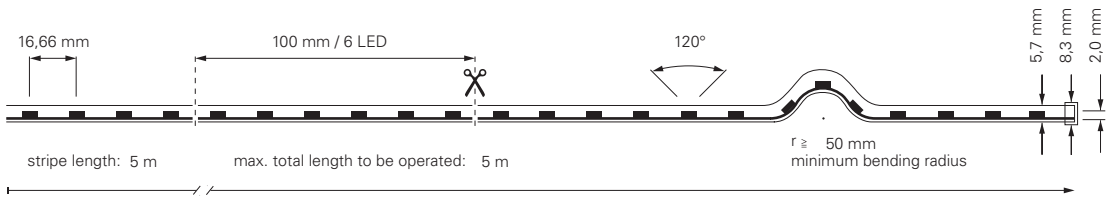

840256 5 m roll 470-630 nm 60 LED/m 12,5 W/m 42,4 lm/W 530 lm/m **159,95 €**

CV	24 Volt	SMD 5050		3 CH	IP67	-15°C +50°C
----	---------	----------	--	------	------	----------------

incl. accessories: 10x retaining bracket, 20x stainless steel screw, 2x endcap

STANDARD | 4CH | 24V

LED stripes in RGB + 3000K, 4000K, 6500K

These LED stripes are ideally suited for all standard applications and special assemblies with the most diverse requirements. With these LED stripes, you have the option of setting single colours, warm white, neutral white, cold white or mixed colours as desired through flexible control.



5050-96-24V-RGB+3000K-5M

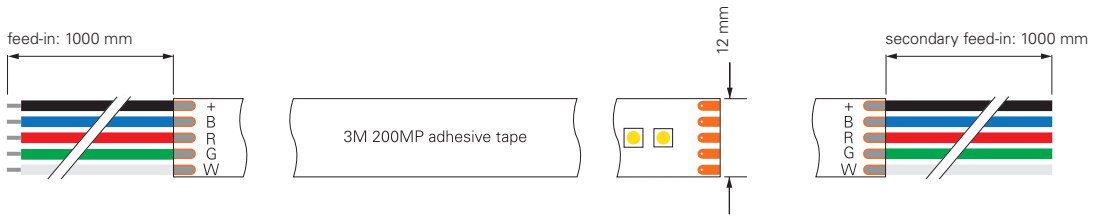
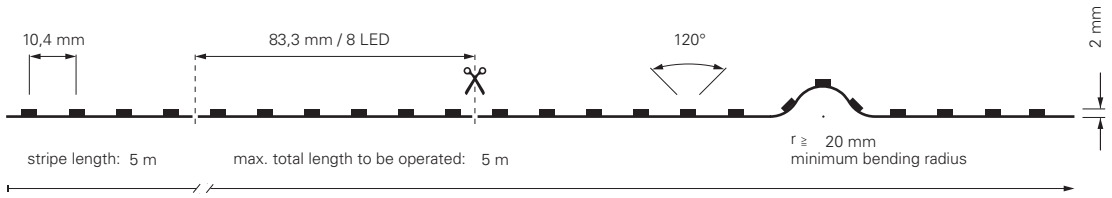

840144 5 m roll 450-630 nm 96 LED/m 14W/m 41,79 lm/W 585 lm/m **173,95 €**



5050-60-24V-RGB+3000K-5M + 5050-60-24V-RGB+3000K-50M

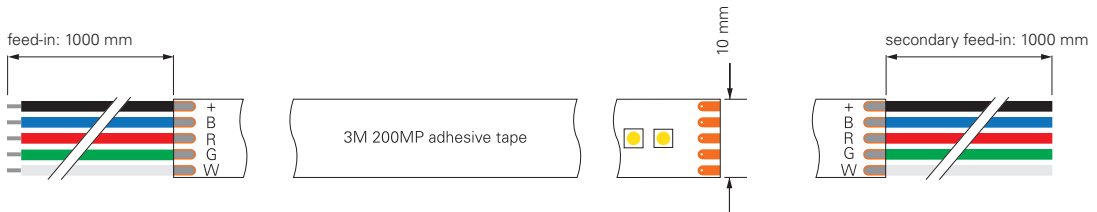
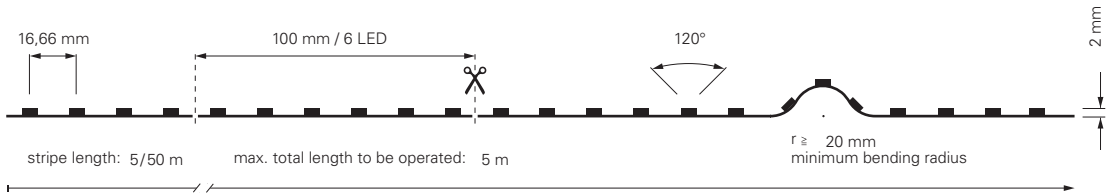

840236 5 m roll 450-630 nm 60 LED/m 16 W/m 51,25 lm/W 820 lm/m **149,95 €**

930517 50 m roll 450-630 nm 60 LED/m 16 W/m 51,25 lm/W 820 lm/m **1299,95 €**



5050-60-24V-RGB+4000K-5M / RGB+4000K-50M / RGB+6500K-5M

new

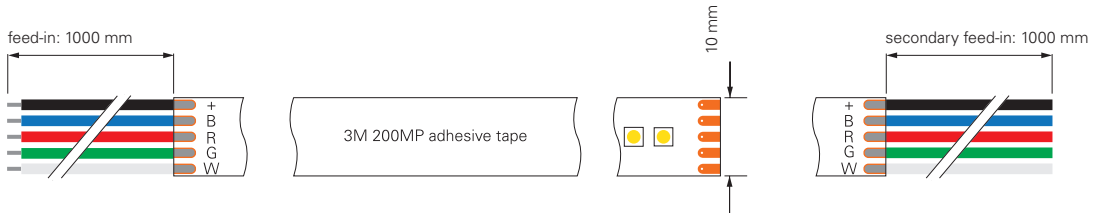
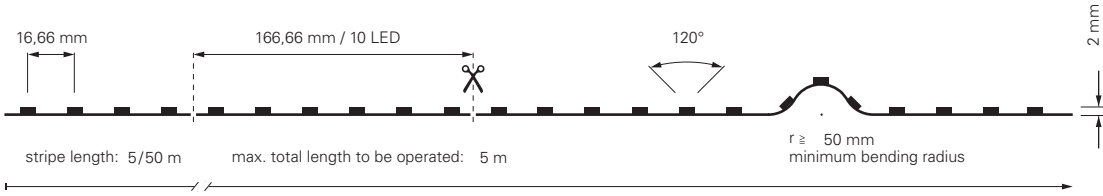

840353	5 m roll	RGB	NW	460-630 nm	60 LED/m	16,5 W/m	46,97 lm/W	775 lm/m	149,95 €
840354	50 m roll	RGB	NW	460-630 nm	60 LED/m	16,5 W/m	46,97 lm/W	775 lm/m	1399,95 €
840356	5 m roll	RGB	cw	460-630 nm	60 LED/m	16,5 W/m	48,18 lm/W	795 lm/m	149,95 €



3535-192-24V-RGB+3000K-5M / RGB+4000K-5M

new

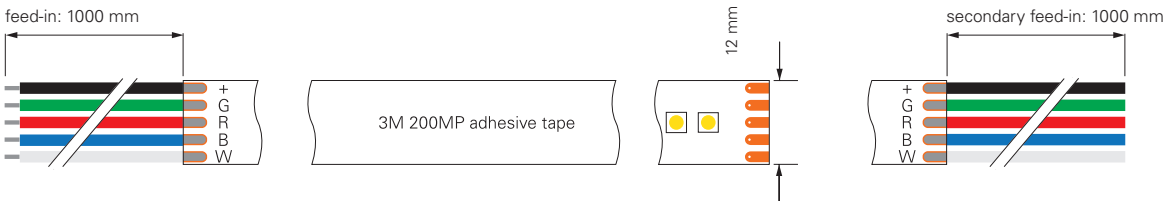
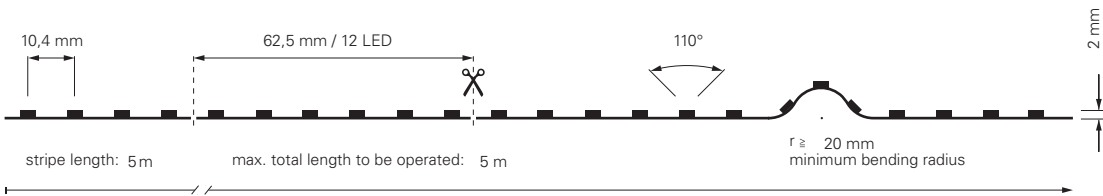

840308	5 m roll	RGB	WW	470-630 nm	192 LED/m	22 W/m	43,41 lm/W	955 lm/m	173,95 €
840309	5 m roll	RGB	NW	470-630 nm	192 LED/m	22 W/m	44,77 lm/W	985 lm/m	173,95 €



5050-60-24V-RGB+4000K / RGB-6500K-5M-SILIKON

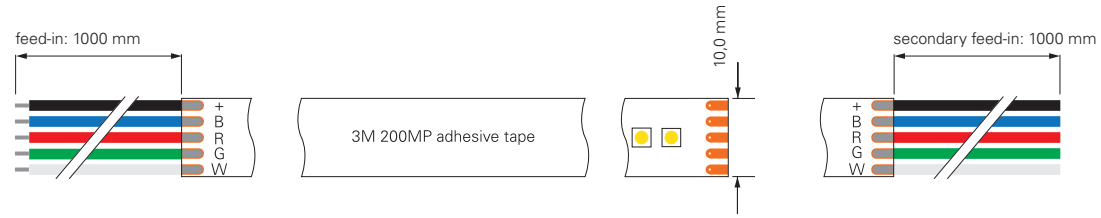
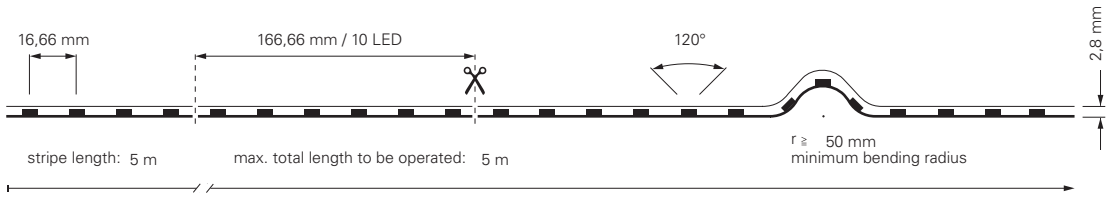

840373	5 m roll	RGB NW	460-630 nm	60 LED/m	16,0 W/m	47,81 lm/W	765 lm/m	159,95 €
840357	5 m roll	RGB CW	460-630 nm	60 LED/m	16,5 W/m	50,91 lm/W	840 lm/m	159,95 €

CV 24 Volt SMD 5050 Ra 80 4 CH IP44 -15°C +50°C

5050-60-24V-RGB+3000K-5M-SILIKON

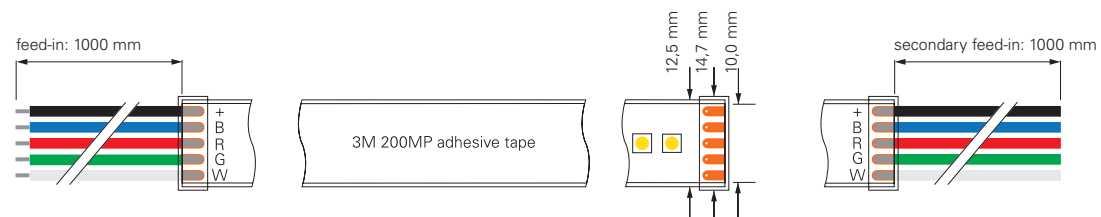
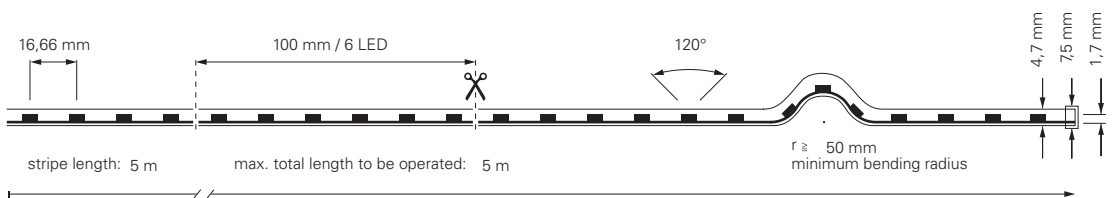

840239	5 m roll	RGB WW	450-630 nm	60 LED/m	15 W/m	49 lm/W	735 lm/m	179,95 €
---------------	----------	--------	------------	----------	--------	---------	----------	-----------------

CV 24 Volt SMD 5050 4 CH IP67 -15°C +50°C

incl. accessories: 10x retaining bracket, 20x stainless steel screw, 2x endcap

STANDARD | 3+2CH | 24V

LED stripes in RGB + 2700 - 6500K

These LED stripes cover all applications and special assemblies with the most diverse and highest requirements. This special design is a 3+2 channel LED stripe. These can be controlled separately from each other [RGB /2700K - 6500] thanks to the separate assignment and double feed.

5050-72-24V-RGB+2700K-6500K-5M / RGB+2700K-6500K-50M

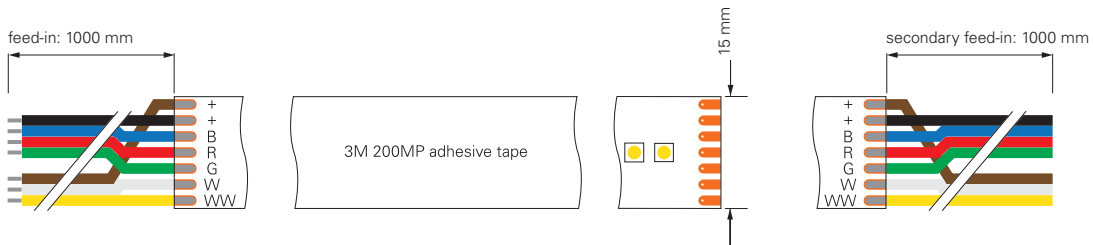
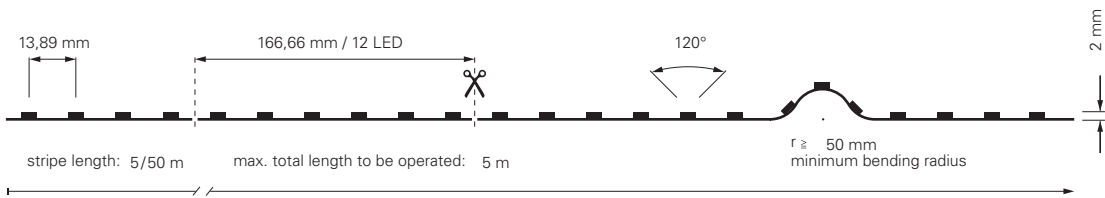

840359	5 m roll		460-630 nm	72 LED/m	15,5 W/m	66,77 lm/W	1035 lm/m	269,95 €
840360	50 m roll		460-630 nm	72 LED/m	15,5 W/m	66,77 lm/W	1035 lm/m	2499,95 €

CV	24 Volt	SMD 5050	Ra 80		3+2 CH	IP20	-15°C +50°C
----	---------	----------	-------	--	--------	------	----------------



5050-72-24V-RGB+2700K-6500K-5M-SILIKON

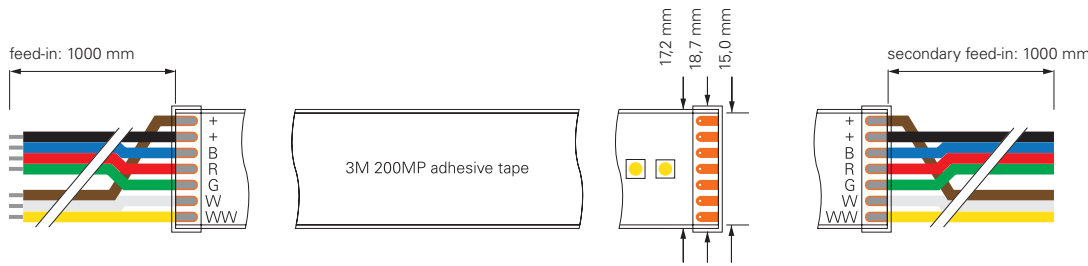
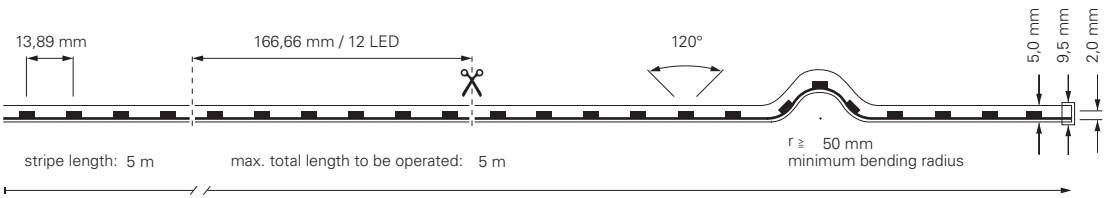

840358 5 m roll RGB WW CW 460-630 nm 72 LED/m 15,5 W/m 61,94 lm/W 960 lm/m **299,95 €**

CV	24 Volt	SMD 5050	Ra 80		IP65	-15°C +50°C
----	---------	----------	-------	--	------	----------------

incl. accessories: 10x retaining bracket, 20x stainless steel screw, 2x endcap

D LENSE LINE | 1CH | 24V

D LENSE LINE in warm white 3000K

These special LED stripes are equipped with lenses, making it possible to realise a targeted light emission [beam angle with 10° or 45°].



D LENSE LINE IP67 3000K 10°

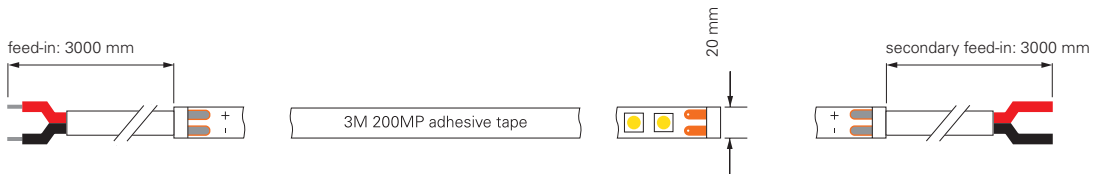
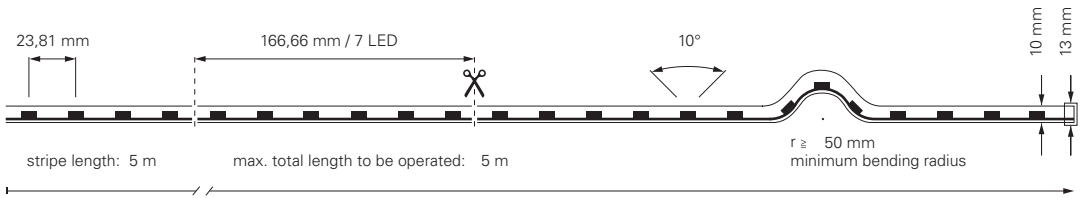



840297 5 m roll  3000K [±150K] 210 LED/m 13,5 W/m 110,37 lm/W 1490 lm/m **289,95 €**

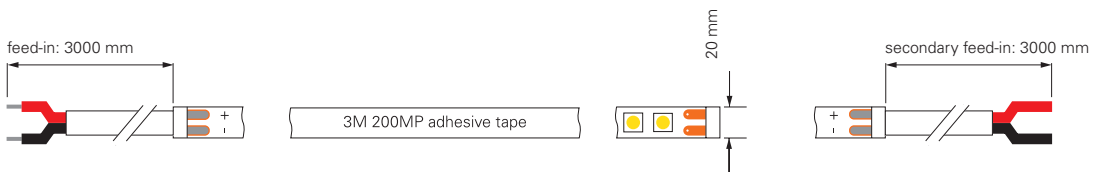
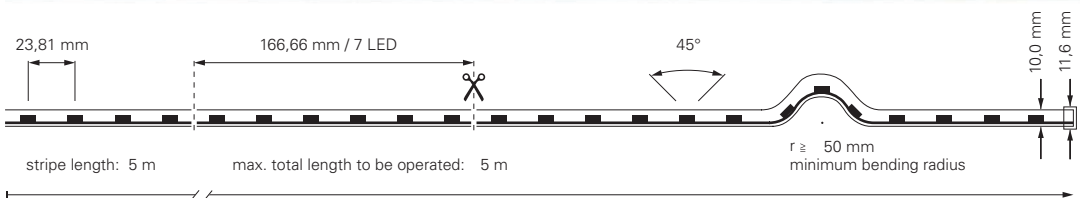

incl. accessories: 6x retaining clip, 6x stainless steel screw

D LENSE LINE IP67 3000K 45°



840298 5 m roll  3000K [±150K] 210 LED/m 13,5 W/m 97,78 lm/W 1320 lm/m **289,95 €**



incl. accessories: 6x retaining clip, 6x stainless steel screw

D LENSE LINE | 3CH | 24V

D LENSE LINE in RGB

These special LED stripes are equipped with lenses, making it possible to realise a targeted light emission (beam angle with 10° or 45°).

Flexible control gives you the option of specifically setting individual or mixed colours.



D LENSE LINE IP67 RGB 10°

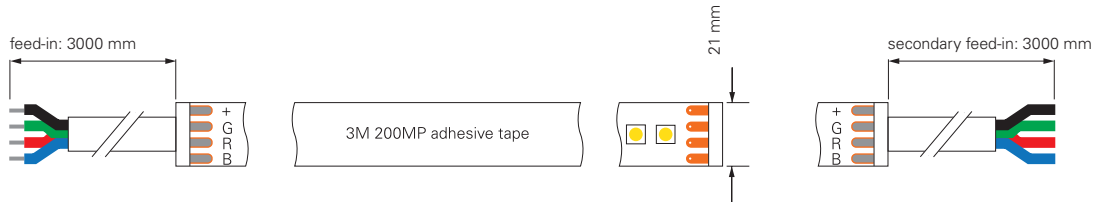
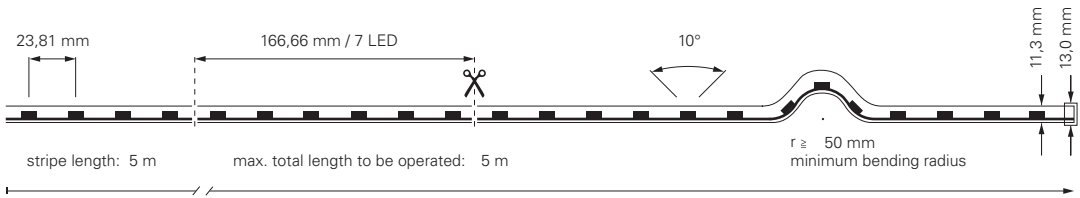



840299 5 m roll  470-630 nm 210 LED/m 36,2W/5m 8 W/m/36,88 lm/W 298 lm/m **299,95 €**

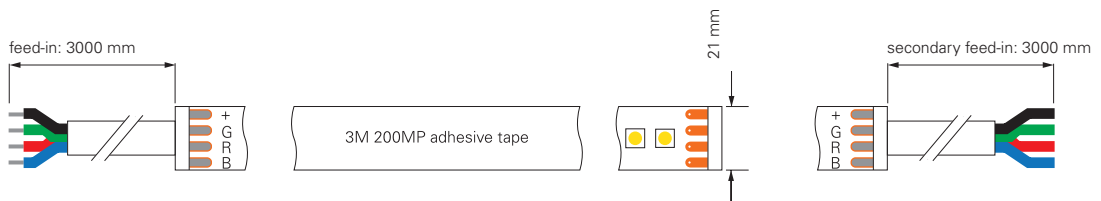
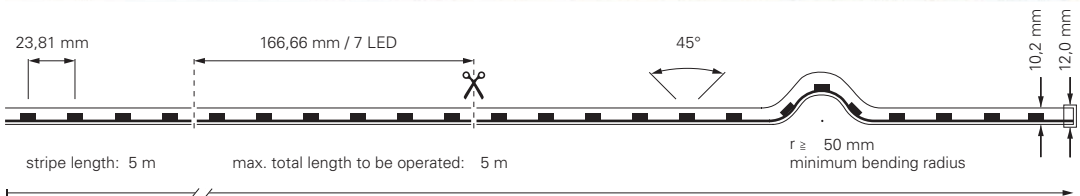

incl. accessories: 6x retaining clip, 6x stainless steel screw

D LENSE LINE IP67 RGB 45°



840300 5 m roll  470-630 nm 210 LED/m 8 W/m 40 lm/W 320 lm/m **299,95 €**



incl. accessories: 6x retaining clip, 6x stainless steel screw

D FLEX LINE – FLEXIBLE IN MANY WAYS

Are you looking for a flexible, water-protected and homogeneously illuminated LED stripe? With our D FLEX LINE series, we combine all requirements in one continuous row. Our D Flex Line stripes are available in two basic versions, as Top View and Side View. The difference lies in the built-in positioning of the LED stripes, because this results in two significant differences in the possible mounting / placement of the stripes.

Due to a completely flexible potting, the D FLEX LINE achieve a degree of protection of up to IP68 as well as a completely homogeneous light pattern in the different LED stripes versions warm white, RGB and RGB + warm white due to the respective placement of the LED stripe. The shape and encapsulation also have a significant influence on the radiation behaviour of our strips, allowing you to achieve a beam angle of up to 180°.

The maximum total length to be operated is 5m. You can shorten the continuous rooflights at the and marked points. Each D Flex Line stripe is supplied with a feed and secondary feed of 3m each. This ensures a flexible, convenient and simple installation is guaranteed. The feed is supplied with tinned wire ends. In addition, our D FLEX LINE tapes are flame retardant and resistant to UV, chlorinated water, salt water and commercial cleaners [note content concentrations, not sea water resistant].



TOP VIEW

The LED stripe is arranged / installed horizontally, which means that the flex stripe can be bent up and down. [note the respective minimum bending radius]

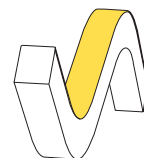

D FLEX LINE TOP VIEW IP68 3000K

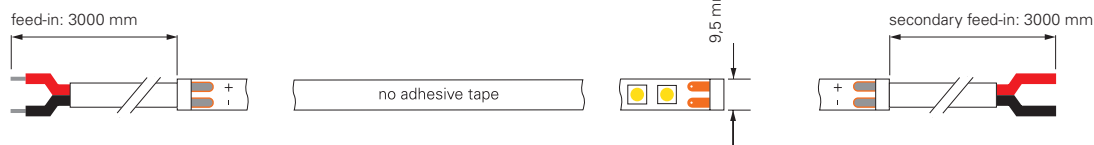
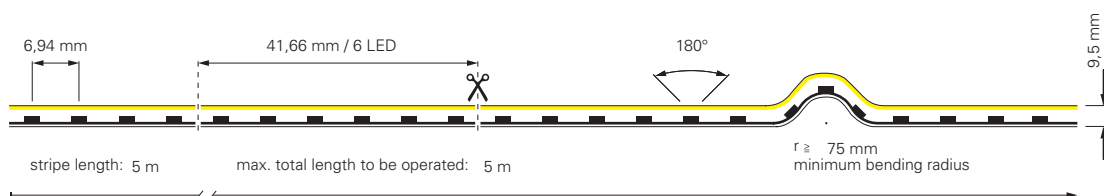

840285 5 m roll  3000K [± 150K] 144 LED/m 10,5 W/m 69,52 lm/W 730 lm/m **469,95 €**



incl. accessories: 10x retaining clip, 10x screw, 2x endcap

- 930446** profile for D Flex Line MINI aluminium anodized L x W x H: 1000 x 12 x 13 mm **12,95 €**
- 930445** profile for D Flex Line MINI plastic | transparent L x W x H: 1000 x 12 x 13 mm **9,95 €**
- 930531** assembly set for D Flex Line | 10 x 10 mm **8,95 €**
- 930593** gel glue for gluing the end caps 3g **4,95 €**

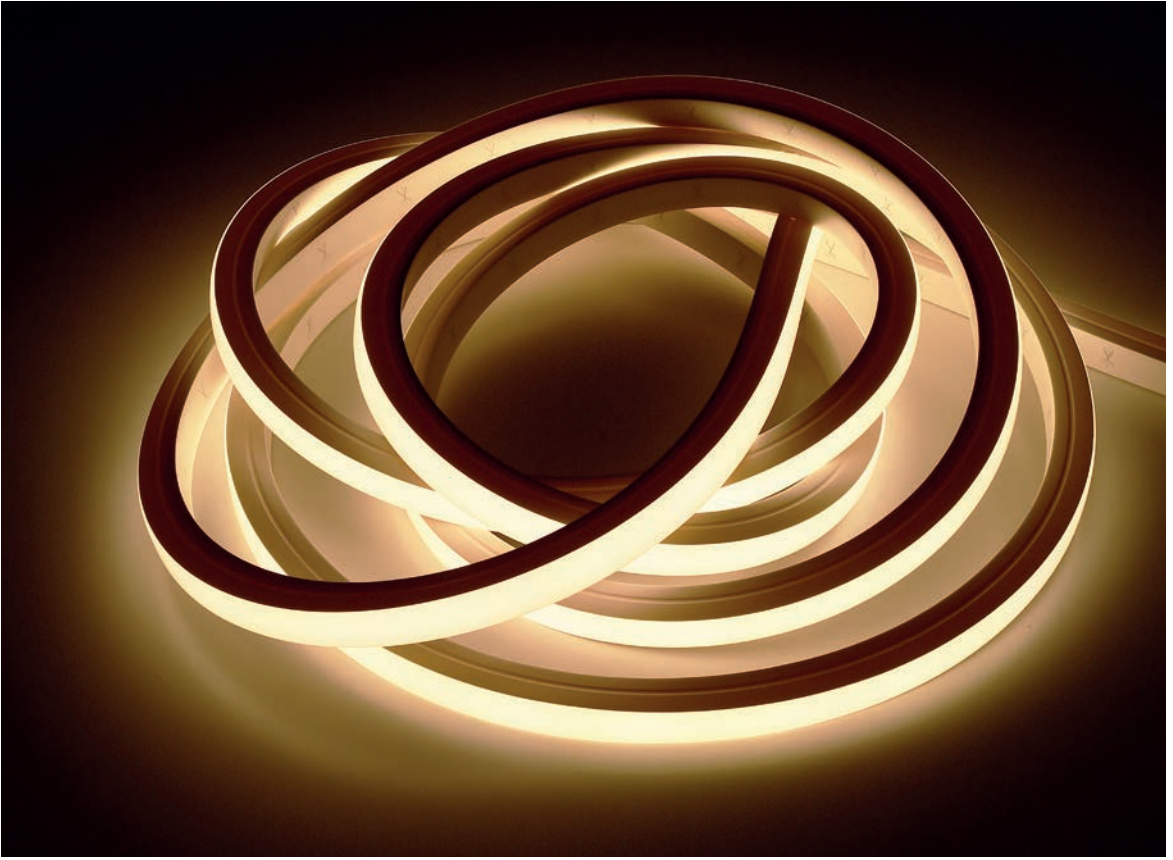

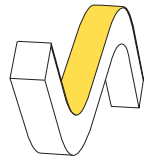

D FLEX LINE MINITOP VIEW IP68 3000K

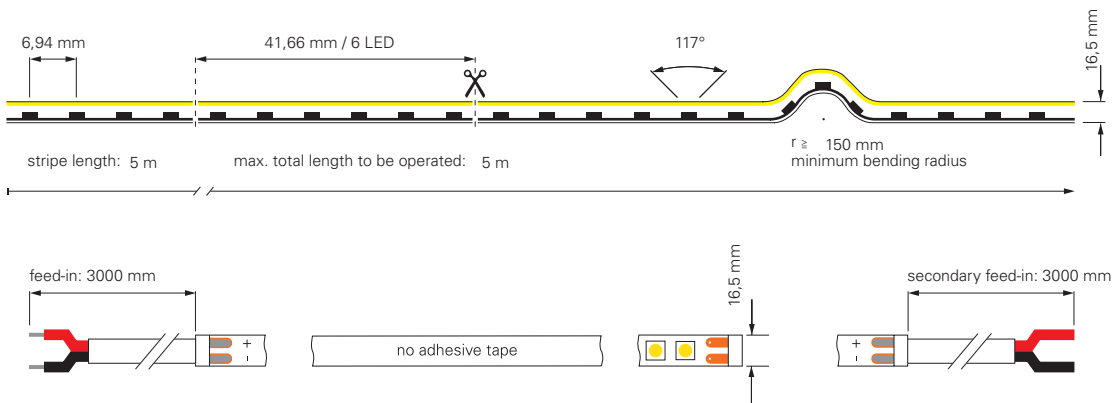

840288 5 m roll  3000K [± 150K] 144 LED/m 10,5 W/m 49,05 lm/W 515 lm/m **689,95 €**



incl. accessories: 10x retaining clip, 10x screw, 2x endcap

- 930448** profile for D Flex Line TOP
aluminium anodized
L x W x H: 1000 x 19 x 18 mm **12,95 €**
- 930449** profile for D Flex Line TOP
plastic | transparent
L x W x H: 1000 x 19 x 18 mm **9,95 €**
- 930533** assembly set for D Flex Line | 16 x 15 mm **8,95 €**
- 930593** gel glue for gluing the end caps 3g **4,95 €**

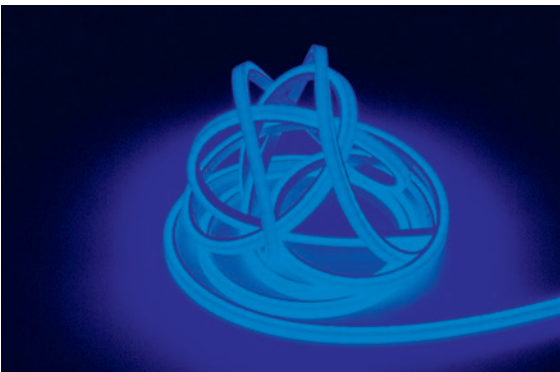
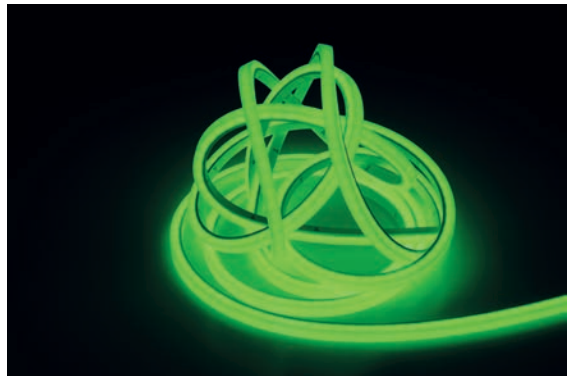
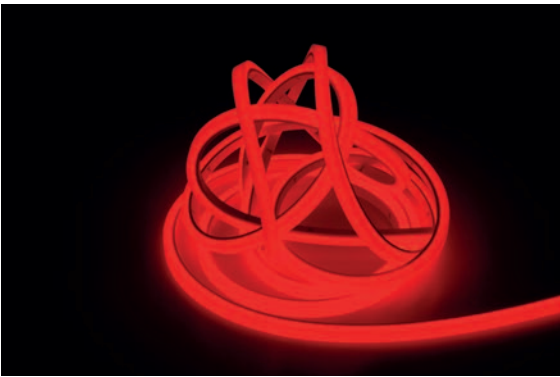
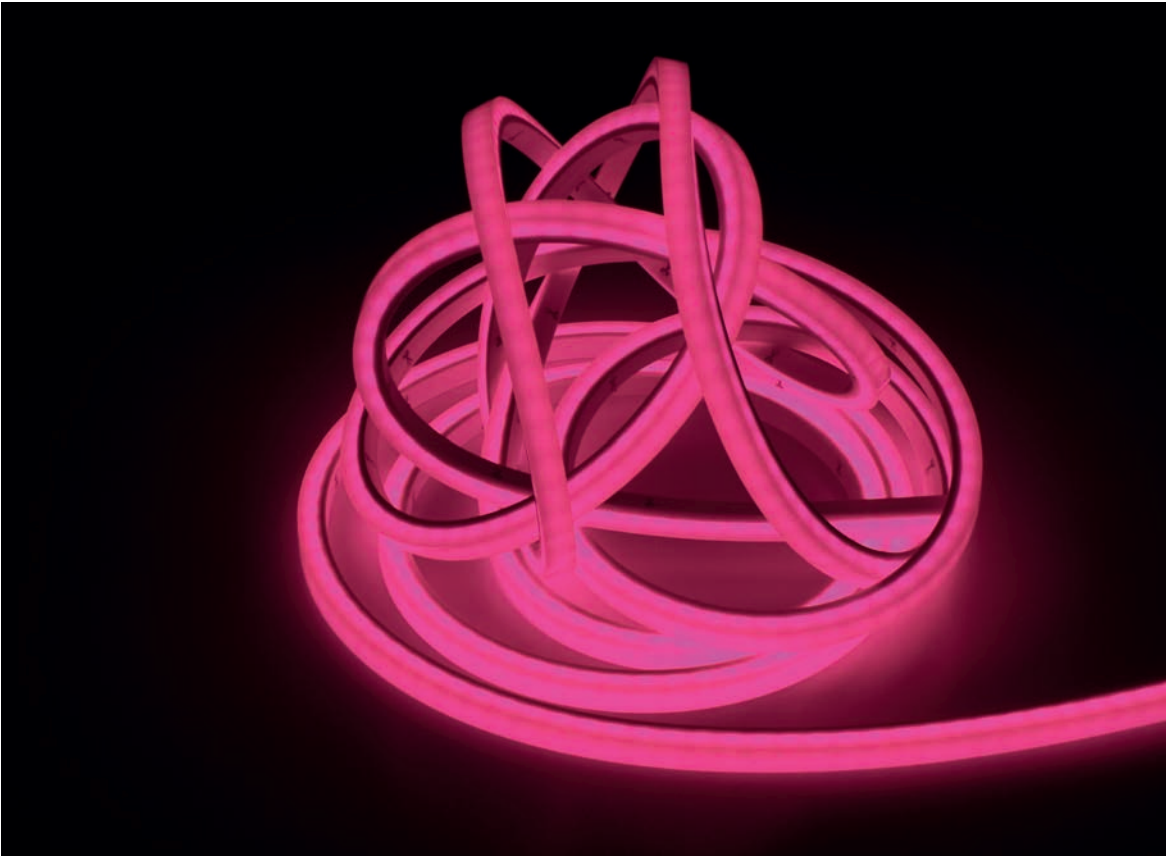



D FLEX LINE TOP VIEW IP68 RGB

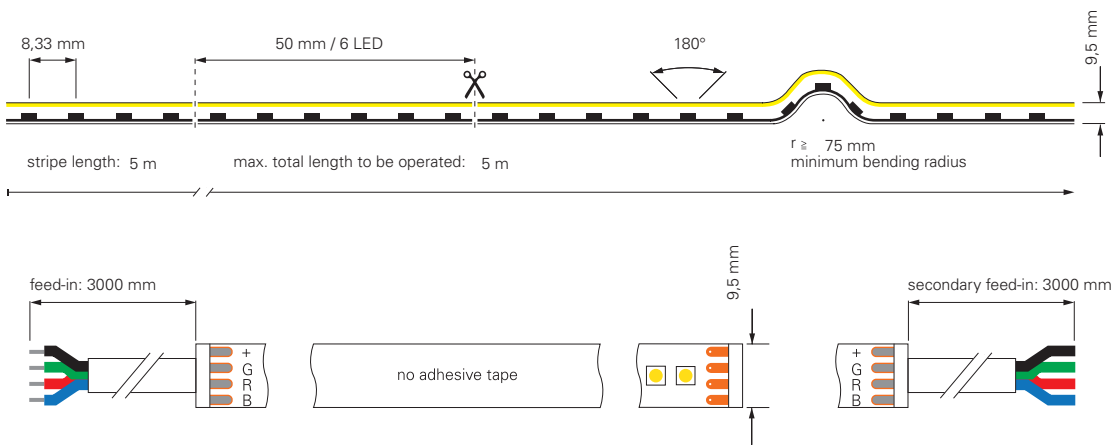

840286 5 m roll  460-620 nm 120 LED/m 10 W/m 31,5 lm/W 315 lm/m **469,95 €**



incl. accessories: 10x retaining clip, 10x screw, 2x endcap

- | | | |
|---------------|---|----------------|
| 930446 | profile for D Flex Line MINI
aluminium anodized
L x W x H: 1000 x 12 x 13 mm | 12,95 € |
| 930445 | profile for D Flex Line MINI
plastic transparent
L x W x H: 1000 x 12 x 13 mm | 9,95 € |
| 930531 | assembly set for D Flex Line 10 x 10 mm | 8,95 € |
| 930593 | gel glue for gluing the end caps 3g | 4,95 € |



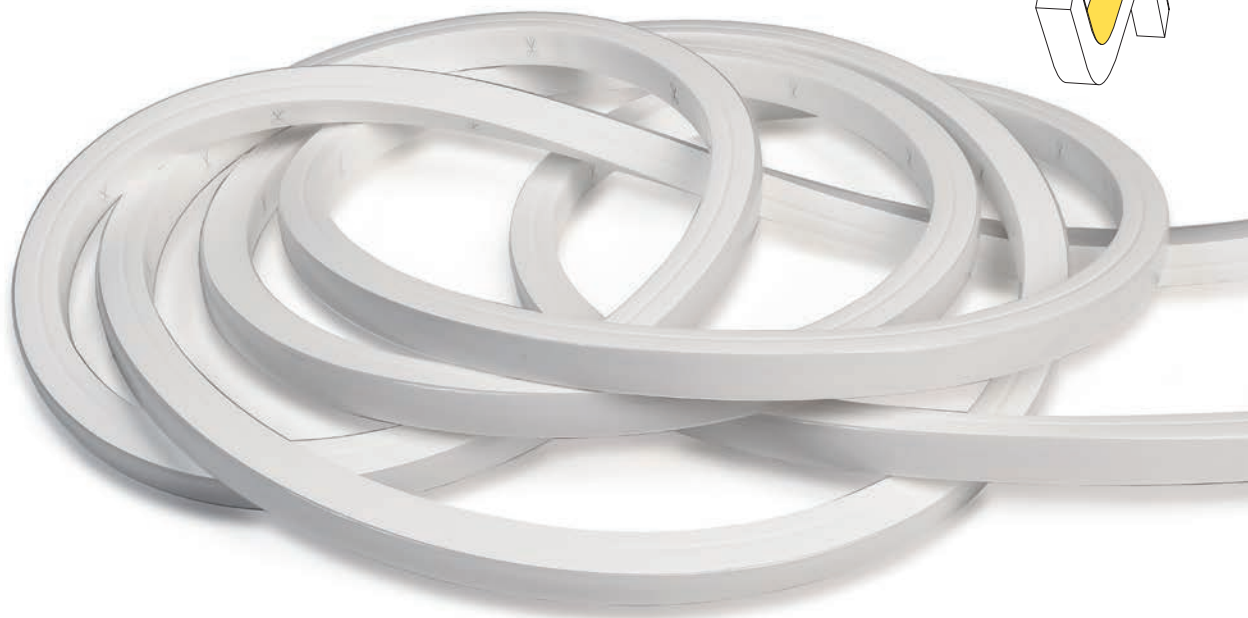
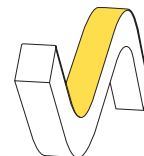

D FLEX LINE TOP VIEW IP68 RGBW

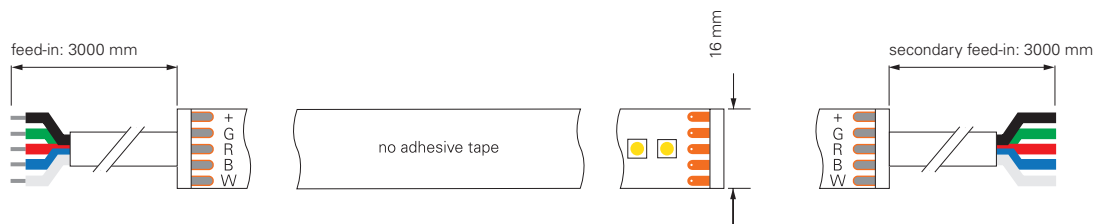
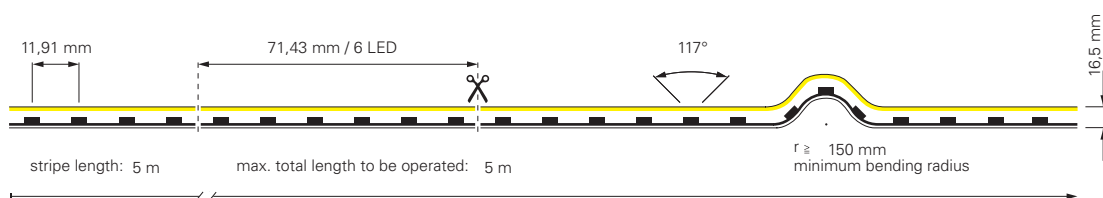

840289 5 m roll 470-620 nm 84 LED/m 10,5 W/m 30,48 lm/W 320 lm/m **689,95 €**



incl. accessories: 10x retaining clip, 10x screw, 2x endcap

- 930448** profile for D Flex Line TOP aluminium anodized L x W x H: 1000 x 19 x 18 mm **12,95 €**
- 930449** profile for D Flex Line TOP plastic | transparent L x W x H: 1000 x 19 x 18 mm **9,95 €**
- 930533** assembly set for D Flex Line | 16 x 15 mm **8,95 €**
- 930593** gel glue for gluing the end caps 3g **4,95 €**



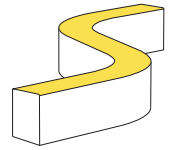

SIDE VIEW

The LED stripe is arranged / installed vertically, which means that the flex stripe can be bent to the left and right. [note the respective minimum bending radius]

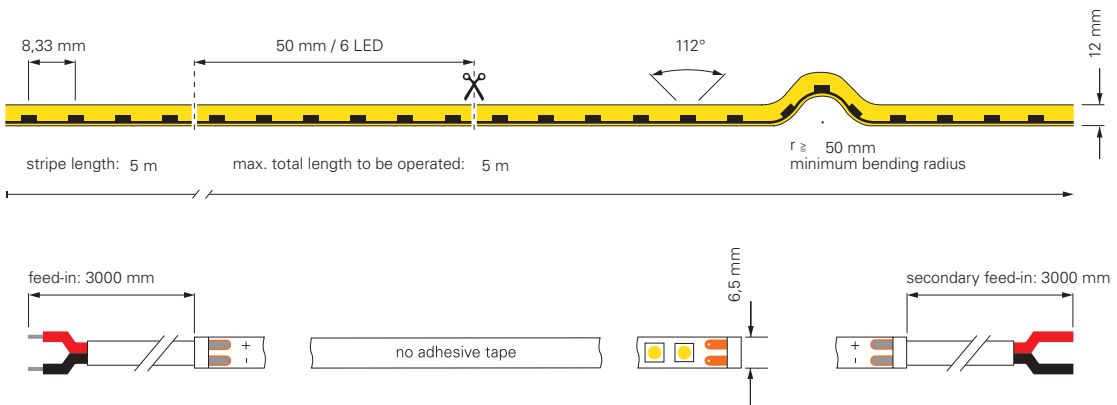

D FLEX LINE MINI SIDE VIEW IP44 3000K



840376 5 m roll  3000K [+/- 150K] 120 LED/m 9,5 W/m 30 lm/W 285 lm/m **299,95 €**



incl. accessories: 10x retaining clip, 10x screw, 2x endcap

- 930443** profile for D Flex Line
aluminium anodized
L x W x H: 1000 x 9 x 13 mm **10,95 €**
- 930444** Flex profile for D Flex Line
aluminium
L x W x H: 500 x 9 x 12 mm **19,95 €**
- 930530** assembly set for D Flex Line | 6,5 x 12 mm **8,95 €**
- 930593** gel glue for gluing the end caps 3g **4,95 €**



D FLEX LINE MINI SIDE VIEW IP68 3000K

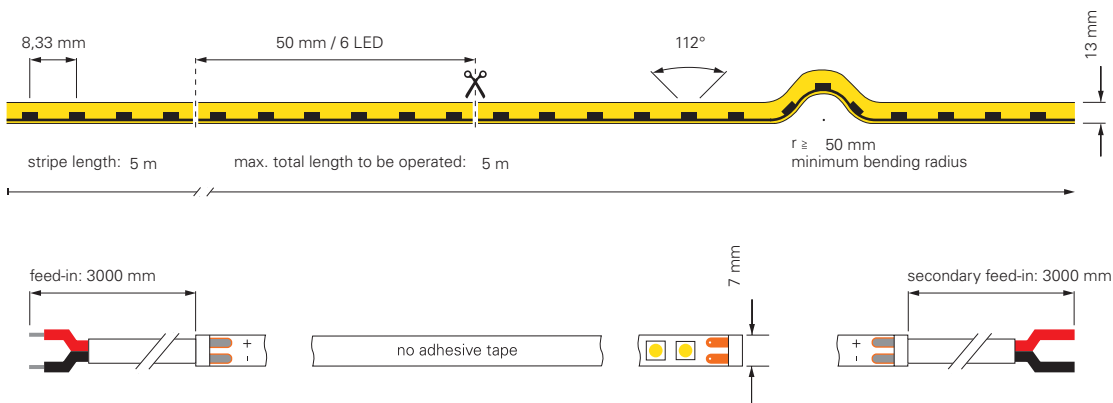

840283 5 m roll  3000K [± 150K] 120 LED/m 8 W/m 36,88 lm/W 295 lm/m **469,95 €**



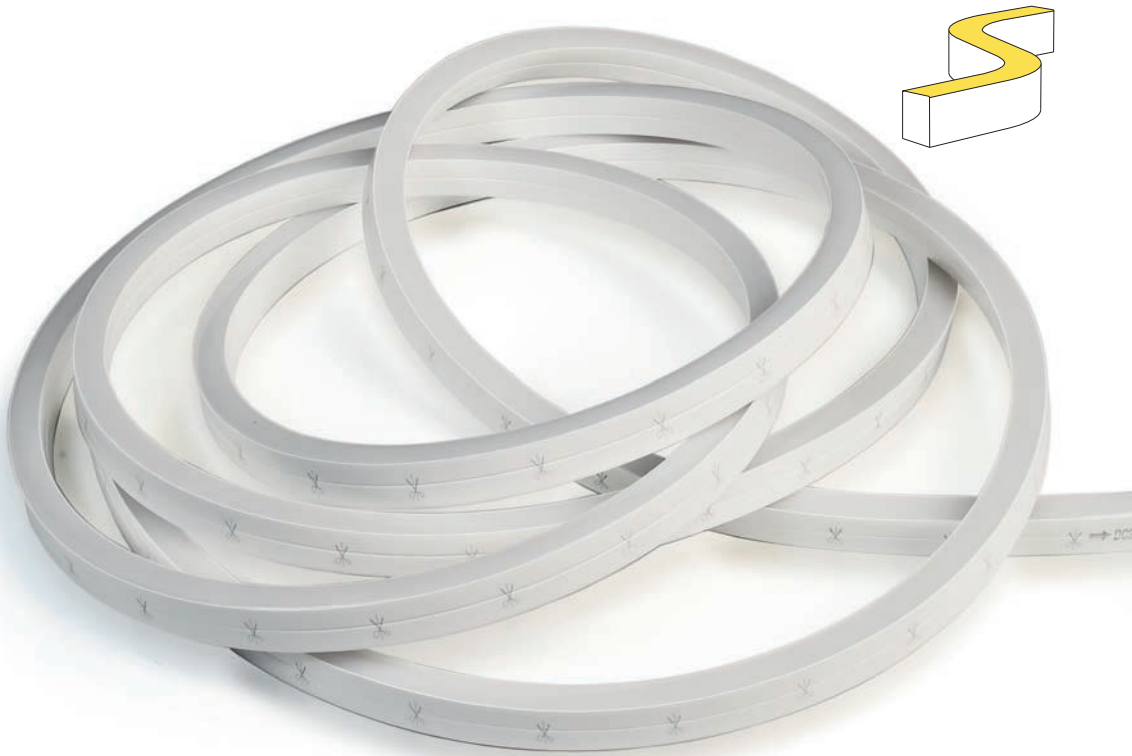

incl. accessories: 10x retaining clip, 10x screw, 2x endcap

- 930443** profile for D Flex Line
aluminium anodized
L x W x H: 1000 x 9 x 13 mm **10,95 €**
- 930444** Flex profile for D Flex Line
aluminium
L x W x H: 500 x 9 x 12 mm **19,95 €**
- 930530** assembly set for D Flex Line | 6,5 x 12 mm **8,95 €**
- 930593** gel glue for gluing the end caps 3g **4,95 €**

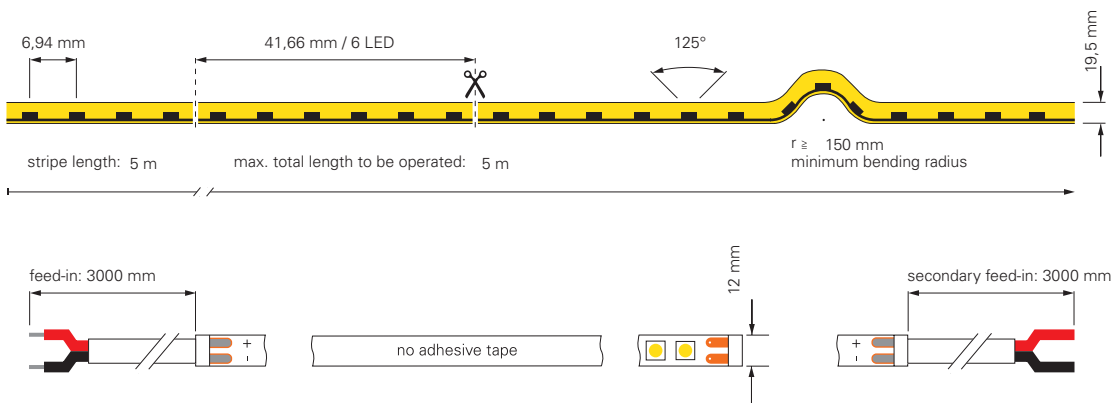

D FLEX LINE MINI SIDE VIEW IP68 3000K



840287 5 m roll  3000K [+/- 150K] 144 LED/m 10,5 W/m 36 lm/W 368 lm/m **689,95 €**



incl. accessories: 10x retaining clip, 10x screw, 2x endcap

- 930447** profile for D Flex Line SIDE aluminium anodized L x W x H: 1000 x 15 x 21 mm **12,95 €**
- 930451** Flex profile for D Flex Line Side aluminium L x W x H: 500 x 15 x 20 mm **24,95 €**
- 930532** assembly set for D Flex Line | 12 x 20 mm **8,95 €**
- 930593** gel glue for gluing the end caps 3g **4,95 €**

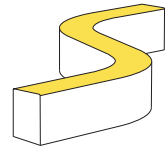

D FLEX LINE MINI SIDE VIEW IP44 RGB

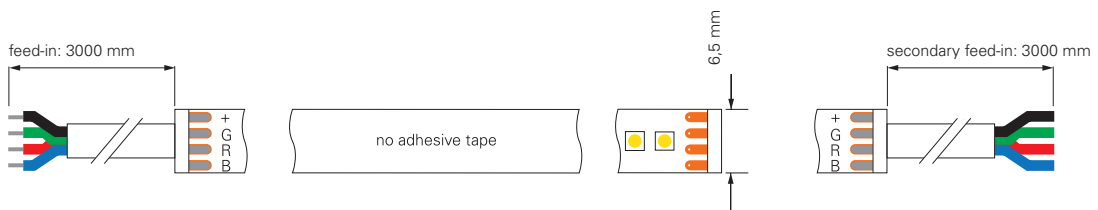
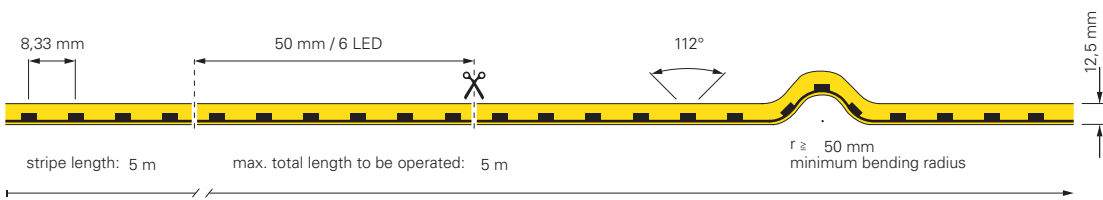

840377 5 m roll  460-620 nm 120 LED/m 10 W/m 12 lm/W 120 lm/m **299,95 €**



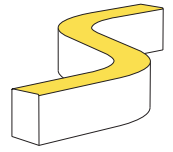

incl. accessories: 10x retaining clip, 10x screw, 2x endcap

- 930443** profile for D Flex Line
aluminium anodized
L x W x H: 1000 x 9 x 13 mm **10,95 €**
- 930444** Flex profile for D Flex Line
aluminium
L x W x H: 500 x 9 x 12 mm **19,95 €**
- 930530** assembly set for D Flex Line | 6,5 x 12 mm **8,95 €**
- 930593** gel glue for gluing the end caps 3g **4,95 €**

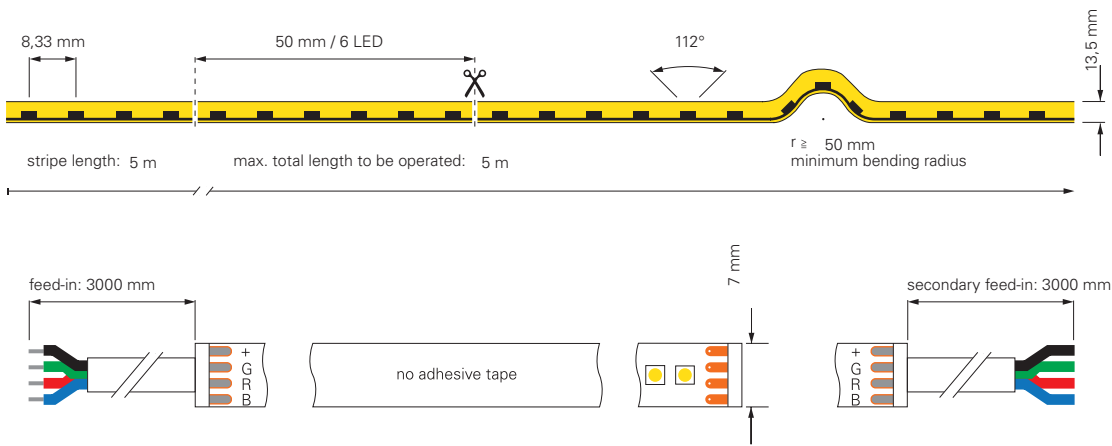

D FLEX LINE MINI SIDE VIEW IP68 RGB



840284 5 m roll  460-620 nm 120 LED/m 8 W/m 13,75 lm/W 110 lm/m **469,95 €**

						
---	---	---	---	---	---	---

incl. accessories: 10x retaining clip, 10x screw, 2x endcap

- 930443** profile for D Flex Line aluminium anodized L x W x H: 1000 x 9 x 13 mm **10,95 €**
- 930444** Flex profile for D Flex Line aluminium L x W x H: 500 x 9 x 12 mm **19,95 €**
- 930530** assembly set for D Flex Line | 6,5 x 12 mm **8,95 €**
- 930593** gel glue for gluing the end caps 3g **4,95 €**

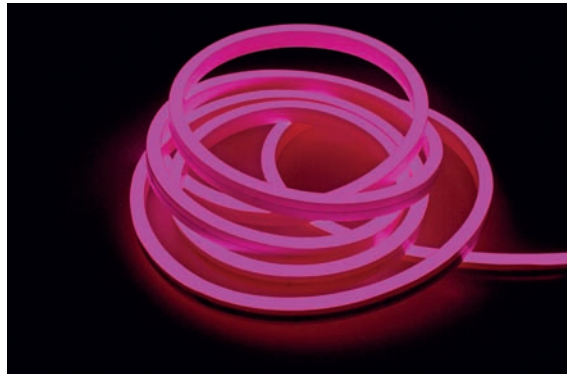
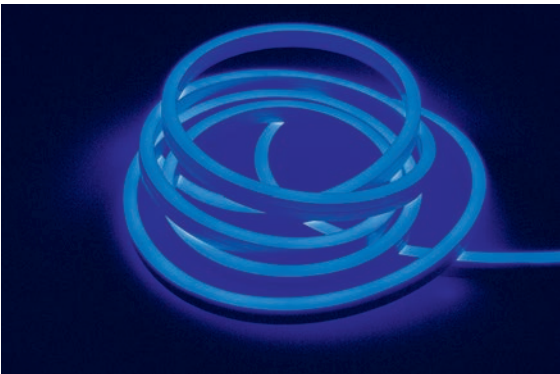
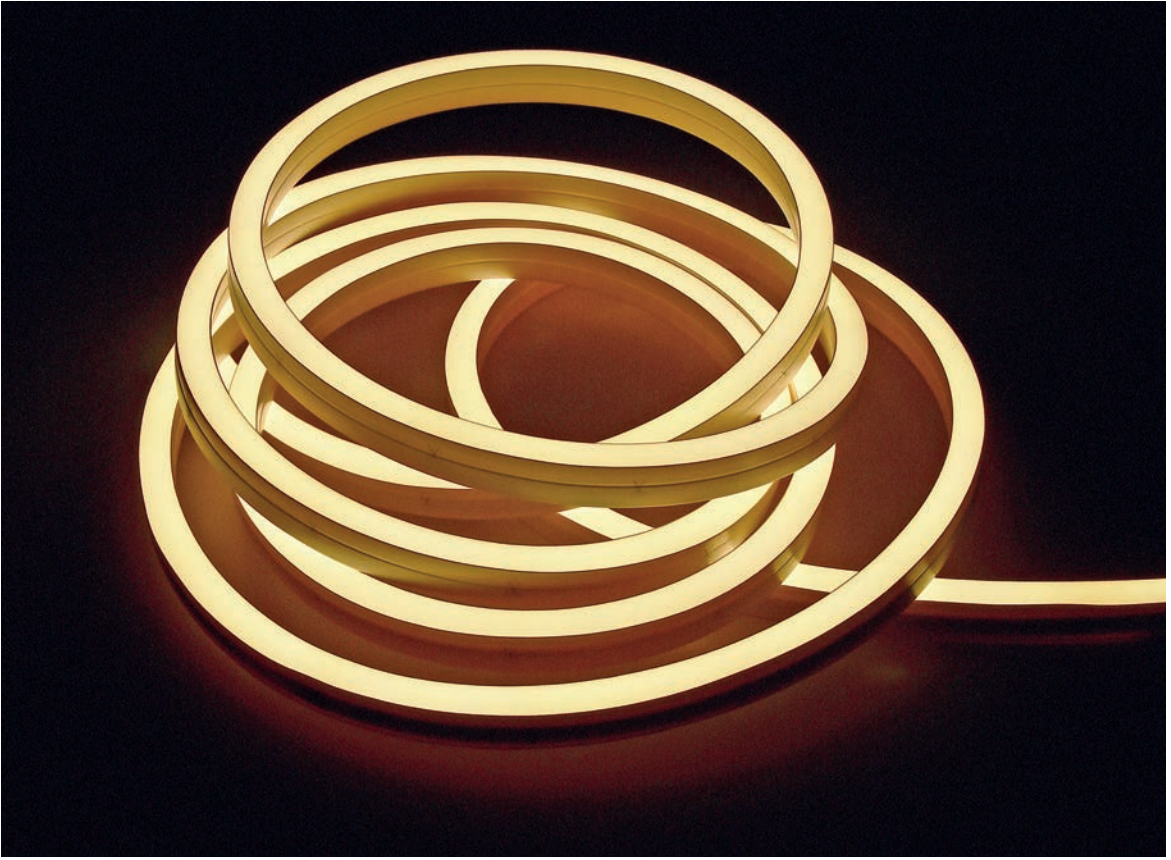



D FLEX LINE SIDE VIEW IP68 RGBW

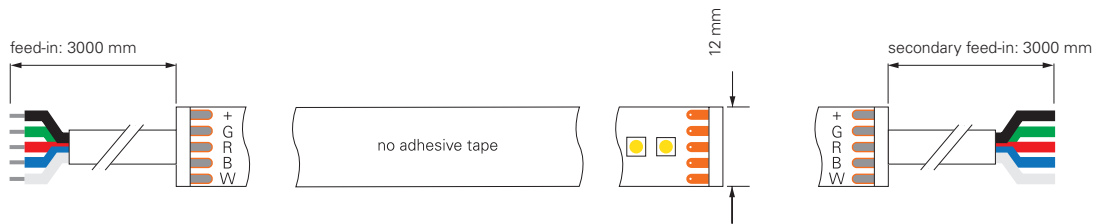
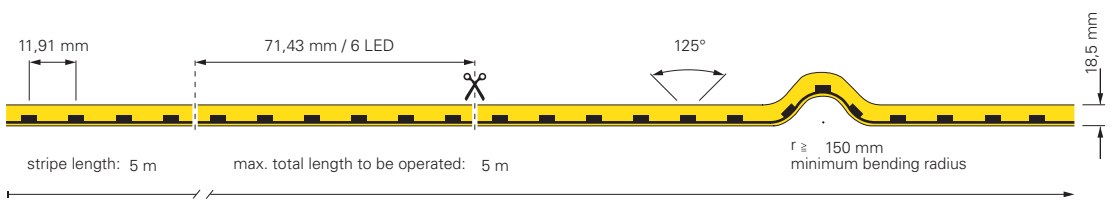

840290 5 m roll  470-630 nm 84 LED/m 10,5 W/m 20 lm/W 210 lm/m **689,95 €**



incl. accessories: 10x retaining clip, 10x screw, 2x endcap

- 930447** profile for D Flex Line SIDE aluminium anodized L x W x H: 1000 x 15 x 21 mm **12,95 €**
- 930451** Flex profile for D Flex Line Side aluminium L x W x H: 500 x 15 x 20 mm **24,95 €**
- 930532** assembly set for D Flex Line | 12 x 20 mm **8,95 €**
- 930593** gel glue for gluing the end caps 3g **4,95 €**

230V | 1CH

This LED stripe is ideally suited if the requirements and focus are on flexible, water-protected and long-lasting lighting routes in indoor and outdoor areas.

Due to the voltage of 230V, no additional power supply unit is required. The delivery is ready for connection with mounted Schuko plug and moulded endcap.

The LED stripe can be dimmed from 100% to 40% by a phase on/phase off dimmer to suit the requirement or ambient lighting.

Applications of large distances, such as on buildings or hotel corridors can be operated in one piece up to 50m.



2835-120-230V-3000K-15M / 3000K-50M / 4000K-15M / 4000K-50M-SILIKON

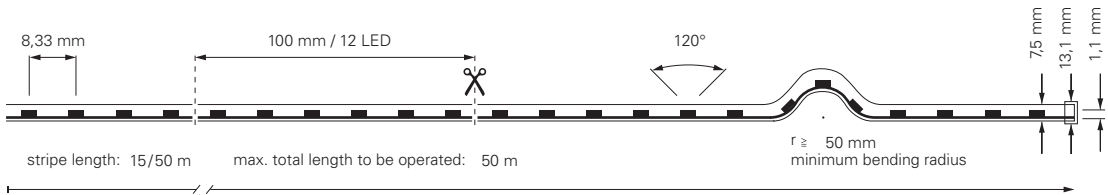

840310	15 m roll	ww	3000K [+/- 150K]	120 LED/m	18 W/m	87,78 lm/W	1580 lm/m	749,95 €
840311	50 m roll	ww	3000K [+/- 150K]	120 LED/m	18 W/m	87,78 lm/W	1580 lm/m	2499,95 €
840312	15 m roll	nw	4000K [+/- 150K]	120 LED/m	19 W/m	89,21 lm/W	1695 lm/m	749,95 €
840313	50 m roll	nw	4000K [+/- 150K]	120 LED/m	19 W/m	89,21 lm/W	1695 lm/m	2499,95 €

230 Volt	SMD 2835	Ra 85	Ra 80		1 CH	IP65	-15°C +50°C
----------	----------	-------	-------	--	------	------	----------------

840310 incl. accessories: 30x clamp, 30x screw, 30x dowel

840311 incl. accessories: 100x clamp, 100x screw, 100x dowel

840312 incl. accessories: 30x clamp, 30x screw, 30x dowel

840313 incl. accessories: 100x clamp, 100x screw, 100x dowel

930560	endcap set 2 pieces	1,95 €
930561	feed-in cable with Schuko plug	29,95 €
930563	Flex connector	24,95 €
930564	assembly brackets set of 10 pieces	7,95 €
930593	gel glue for gluing the end caps 3g	4,95 €

STEP BY STEP GUIDE:
ADDITIONAL FEED | ATTACH FLEX CONNECTOR TO 230V LED STRIPE



ALL STEPS EXPLAINED IN DETAIL

The assembly may only be carried out by a qualified electrician. Please ensure that the 230V LED stripe is disconnected from the power supply during assembly / processing and is secured against being switched on again.

- 1 Shorten the 230V LED stripe at one of the marked / designated points.
- 2 Position the sealing ring around the contacts of the feeder / flex connector plug and push it into the plug as far as possible.
- 3 Bring the plug and LED stripe together. The plug contacts must be inserted on the underside of the LED stripe so that the two components are electrically connected to each other.
- 4 The plug and LED stripe are precisely matched to each other, so the two components must be plugged together as far as possible with a little force [push LED stripe into plug].
- 5 Firmly press the connected components [plug and LED stripe) all the way down into the connection box.
- 6 Place the cover of the connection box at an angle to the wings and press it down with a tilting movement.
- 7 Screw the closed connection box with the two pointed screws [as shown on the housing] from above.
- 8 If the positioning fits, press the two components firmly together. If the silicone adhesive presses on the page, between the inside of the junction box and the plug / LED strip, this is desired. LED stripe presses upwards, this is desirable. This way you can be sure that the silicone glue has been distributed in the inner lower area.
- 9 After complete assembly, check the strength of the connection visually and by bending slightly. When assembling the flex connector, steps 2-9 must be carried out twice [left/right page].
- 10 Setzen Sie den Deckel der Anschlussbox schräg an den Flügeln an.
- 11 Press the lid down firmly with a tilting motion. If the silicone glue pushes out from the sides and top, this is desirable. This way you can be sure that the silicone glue has been distributed inside under the cover.
- 12 Screw the closed connection box with the two pointed screws [as shown on the housing] from above.
- 13 Screw together with the two flat screws [as shown on the casing] from the page.
- 14 Remove excess adhesive without leaving any residue by using a suitable cloth.
- 15 After complete assembly, check the strength of the connection visually and by bending slightly. When assembling the flex connector, steps 2-15 must be carried out twice [left/right page].
- 16 illustration shows the newly mounted feeder
- 17 illustration shows the newly mounted flex connector

STEP BY STEP GUIDE: ATTACH ADDITIONAL END CAP TO 230V LED STRIPE



ALL STEPS EXPLAINED IN DETAIL

The assembly may only be carried out by a qualified electrician. Please ensure that the 230V LED stripe is disconnected from the power supply during assembly / processing and is secured against being switched on again.

- 1 After shortening the 230V LED stripe, you get an open, unprotected end.
- 2 Fill the endcap about 20% - 25% with gel glue. Try to avoid air pockets.
- 3 Endcap and LED stripe are perfectly matched to each other and must be communicated.
- 4 For safety reasons, the endcap sits very tightly on the LED stripe, so the two components must be pushed together with some force. Push the two components together as far as you can. Gel glue is pressed out of the endcap and is desired. This way you can be sure that the adhesive has been distributed inside.
- 5 Remove excess adhesive without leaving any residue by using a suitable cloth.
- 6 illustration shows the newly mounted endcap

- The assembly/processing may only be carried out by a qualified electrician.
- All relevant regulations in connection with the operation of 230V equipment apply.
- To guarantee tightness, take the utmost care to ensure clean and correct processing.
- No liability can be accepted for further processing on your part or for the resulting tightness, positioning and attachment.





POWER SUPPLIES

- 892 technical information
- 895 DC | CV | quick finder
- 899 DC | CV | not dimmable
- 901 DC | CV | not dimmable | IP
- 904 DC | CV | dimmable via leading or trailing edge
- 906 DC | CV | dimmable via 1-10V
- 908 DC | CV | dimmable via DALI / DALI+1-10V / Touch-Dim
- 910 DC | CV | dimmable via KNX
- 911 DC | CV | dimmable via DMX
- 912 DC | CC | quick finder
- 915 DC | CC | not dimmable
- 918 DC | CC | dimmable via leading or trailing edge
- 922 DC | CC | dimmable via DALI / DALI + Intelli-Touch-Dim
- 925 DC | CC | dimmable via KNX
- 926 DC | CC/CV | dimmable via leading edge or Touch-Dim
- 927 AC | CV | quick finder
- 928 AC | CV | dimmable via leading or trailing edge
- 929 AC | CV | dimmable via leading edge
- 930 electronic ballast for metal halide lamps

CONTROLLER

- 934 Quasar
- 944 Casambi Bluetooth
- 946 RF controller | 1 - 4 channel
- 948 RF touchpanel | 1 - 4 channel
- 950 quick finder | DMX controller
- 951 quick finder | DMX dimmer
- 952 DMX wall controller
- 956 DMX controller
- 958 DMX dimmer
- 962 DALI PWM dimmer

LIGHT SOURCES

- 966 G4
- 967 MR16/GU5,3
- 969 GU10
- 971 GU10/ES111
- 972 E14
- 973 E27
- 978 G9 | G53/QR111 | GX53
- 979 R7S
- 980 fluorescent lamp
- 981 metal halide lamps

ACCESSORIES

- 986 indoor | dimming
- 988 indoor | dimming + switching
- 989 indoor | miscellaneous
- 990 indoor | low voltage
- 992 indoor | low voltage | connectors
- 994 outdoor | low voltage | WEIPU HQ connectors
- 998 indoor / outdoor | DMX cable
- 1000 indoor | high voltage
- 1001 indoor | high voltage | connector systems
- 1002 outdoor | high voltage | connector systems
- 1004 outdoor | cable connectors
- 1008 outdoor | mounting accessories
- 1009 indoor / outdoor | mounting material for LED stripes and profile
- 1010 indoor / outdoor | mounting accessories
- 1012 sales assistance | sample case



DC | CV
not dimmable
from page 899



DC | CV
not dimmable | IP
from page 901



DC | CV
dimmable via leading or
trailing edge
from page 904



DC | CV
dimmable via 1-10V
from page 906



DC | CV |
dimmbar via DALI /
DALI+ 1-10V / Touch-Dim
from page 908



DC | CV
dimmable via KNX
page 910



DC | CV
dimmable via DMX
page 911



DC | CC
not dimmable
from page 915



DC | CC
dimmable via leading or
trailing edge
from page 919



DC | CC
dimmbar via DALI /
DALI + Intelli-Touch-Dim
page 922



DC | CC
dimmable via KNX
page 925



DC | CC/CV
dimmable via leading edge
or Touch-Dim
page 926



AC | CV
dimmable via leading or
trailing edge
page 928



AC | CV | dimmable via
leading edge
page 929



electronical ballast
für metal halide lamps
page 931



power supplies



QUALITY, VARIETY AND TECHNICAL DATA FOR YOUR ELECTRICAL PLANNING

THE RIGHT POWER SUPPLY UNIT FOR EVERY APPLICATION

The DEKO-LIGHT power supplies are available in different designs. This means you always have exactly the right power supply unit in the right size for every installation situation and every application. Universally applicable, in best and proven quality.

power supplies design

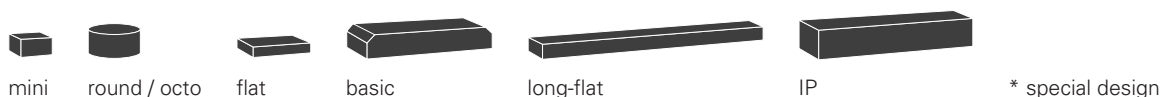

DO YOU ALREADY KNOW OUR LONG-FLAT POWER SUPPLIES?

These power supplies have a lot of power up to 150 watts of concentrated power with a cross-section of just 30 x 22 mm! This power supply unit therefore fits in almost all ceiling covers, shadow gaps or in all other installation situations with little space.



MULTI-POWER SUPPLIES FROM DEKO-LIGHT

All power supplies of the Multi series have one thing in common: They are incredibly versatile and are real multitaskers in daily use. Currently, they are mostly found in the area of constant current power supplies [CC] and can be individually adjusted by means of small microswitches, so-called DIP switches. Therefore different current intensities with different voltage ranges can be selected. For the technician on site, this means that he can supply more than 90% of all common luminaires and control standards very flexibly and with only a few different types of power supply units.

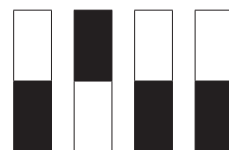

DIP switches on 1 2 3 4

Tip:

If a LED light [CC] is too bright and you want to dim it permanently without having to install additional components, then simply use one of the lower currents of a compatible multi power supply.

WIRE CROSS SECTION

When installing voltage-stable [CV] or current-stable [CC] power supply units and associated components, always ensure that the cable cross-sections are sufficiently dimensioned, especially with regard to the dependence of the cable length.

The specified cable cross-sections [mm²] were adapted to the commercially available cross-sections. The maximum cable length of 10 m should not be exceeded. »Red values« must be avoided urgently.

12 V	2 m	5 m	10 m	12 m
25 W	0,25	0,75	1,50	[2,50]
50 W	0,75	1,50	4,00	[4,00]
75 W	1,00	2,50	4,00	[6,00]
100 W	1,50	4,00	6,00	[10,00]
125 W	1,50	4,00	10,00	[10,00]
150 W	2,50	6,00	10,00	-
200 W	2,50	6,00	-	-
300 W	4,00	10,00	-	-
400 W	6,00	-	-	-

24 V	2 m	5 m	10 m	12 m
25 W	0,25	0,25	0,50	[0,50]
50 W	0,25	0,50	0,75	[1,00]
75 W	0,25	0,75	1,00	[1,50]
100 W	0,50	0,75	1,50	[2,50]
125 W	0,50	1,00	2,50	[2,50]
150 W	0,50	1,50	2,50	[4,00]
200 W	0,75	1,50	4,00	[4,00]
300 W	1,00	2,50	6,00	-
400 W	1,50	4,00	6,00	-

48 V	2 m	5 m	10 m	12 m
25 W	0,25	0,25	0,25	[0,25]
50 W	0,25	0,25	0,25	[0,25]
75 W	0,25	0,25	0,50	[0,50]
100 W	0,25	0,25	0,50	[0,50]
125 W	0,25	0,25	0,50	[0,75]
150 W	0,25	0,50	0,75	[0,75]
200 W	0,25	0,50	1,00	[1,00]
300 W	0,25	0,75	1,50	[1,50]
400 W	0,50	1,00	2,50	[2,50]

PLANNING ELECTRICAL INSTALLATIONS EVEN BETTER

You will certainly notice the new technical data when browsing through our power supplies and ask yourself what it is all about? In future, we would like to support you even better in the planning and dimensioning of your installations. The background to this is that more and more power supplies for lighting are already being installed in standard buildings [directly in the luminaires or as an external power supply].

Due to the inrush currents inherent in the design, e.g. after a power failure and the subsequent simultaneous start of all power supplies, an overload of the circuit breakers may occur. In order to be able to take this into account during the planning stage, we provide you with the necessary data for all our power supplies.

INRUSH CURRENT

In future, you will find the specification of the maximum inrush current directly with our power supply units. The maximum current value [amperes/A], is specified in connection with the respective time [microseconds/ μ s] and defines when exactly the highest current consumption occurs after the mains voltage is applied. You will find this limit value again with many manufacturers in the data sheets of corresponding components, as this can lead to an overload/damage.

DEKO-LIGHT POWER SUPPLIES | DESIGN FLAT

- plastic housing
- suitable for indoor use
- flicker free
- short-circuit proof and overload protection
- overheat control

872629	■	12V	6W	0-500mA	7A/300 μ s	98 x 46 x 11 mm	16,95 €
872632	■	12V	12W	0-1000mA	8A/300 μ s	128 x 50 x 13 mm	19,95 €
872635	■	12V	20W	0-1670mA	12A/300 μ s	128 x 50 x 14 mm	22,95 €
862121	■	12V	50W	0-4160mA	15A/300 μ s	185 x 62 x 22 mm	54,95 €

HOW MANY POWER SUPPLY UNITS PER CIRCUIT BREAKER?

The maximum number of power supply units that may be connected to the respective circuit breaker is directly dependent on the inrush current. In our quick finders you will find the number for the most common types of circuit breaker [B10A, B16A, C10A, C16A].

CAPACITIVE LOAD OF POWER SUPPLIES

Due to their design, power supplies sometimes represent very different capacitive loads. Especially in combination with motion detectors, twilight switches or switching/dimming actuators, this value [as with the capacitor in nF/pF], which is available for many power supplies and specified in our quick finders, plays an important role with regard to the suitability and durability of all components. Please also refer to the manufacturer's data sheets.

electr. data		dimmable via					usage / design			electrical limit values		power supply		
voltage	power	leading / trailing edge	1 - 10V	touch dimmer (Push)	DMX	DALI BUS ready	KNX	indoor	outdoor	design	capacitive load	max. quantity per automatic circuit breaker	item number	page
12V	20W							x		flat	185.8nF	B10A=17, B16A=28, C10A=37, C16A=59	872635	900
12V	2,5-25W	x						x		basic	53.73nF	B10A=35, B16A=56, C10A=74, C16A=118	862051	904
12V	40W							x		basic	251.7nF	B10A=11, B16A=18, C10A=24, C16A=39	862162	901

electr. data		dimmable via						usage / design			electrical limit values		power supply	
voltage	power	leading / trailing edge	1 - 10V	touch dimmer [Push]	DMX	DALI BUS ready	KNX	indoor	outdoor	design	capacitive load	max. quantity per automatic circuit breaker	item number	page
12V	4 W							x	x	mini		B10A=59, B16A=94, C10A=123, C16A=197	872127	899
12V	6 W							x		flat	38.83nF	B10A=17, B16A=28, C10A=37, C16A=59	872629	900
12V	12 W							x	x	octo	45.47nF	B10A=35, B16A=56, C10A=74, C16A=118	872040	899
12V	12 W							x		flat		B10A=17, B16A=28, C10A=37, C16A=59	872632	900
12V	20 W							x		flat	185.8nF	B10A=17, B16A=28, C10A=37, C16A=59	872635	900
12V	2,5-25 W	x						x		basic	53.73nF	B10A=35, B16A=56, C10A=74, C16A=118	862051	904
12V	40 W							x		basic	251.7nF	B10A=11, B16A=18, C10A=24, C16A=39	862162	901
12V	40 W							x	x	IP	621.5nF	B10A=5, B16A=9, C10A=12, C16A=19	872082	901
12V	40 W							x	x	IP		B10A=6, B16A=9, C10A=10, C16A=16	872097	902
12V	40 W			x		x		x		*		B10A=8, B16A=14, C10A=18, C16A=29	843277	908
12V	45 W							x		long-flat	462.1nF	B10A=5, B16A=9, C10A=12, C16A=19	862123	900
12V	50 W							x		flat	485.5nF	B10A=11, B16A=18, C10A=24, C16A=39	862121	900
12V	12-50 W	x						x		basic	46.13nF	B10A=35, B16A=56, C10A=74, C16A=118	862053	904
12V	60 W							x		long-flat	462.1nF	B10A=5, B16A=9, C10A=12, C16A=19	862093	900
12V	60 W							x	x	IP		B10A=6, B16A=9, C10A=10, C16A=16	872098	902
12V	60 W						x	x	x	IP		B10A=6, B16A=9, C10A=10, C16A=16	872109	910
12V	75 W							x		basic	870nF	B10A=11, B16A=18, C10A=24, C16A=39	862127	901
12V	75 W							x	x	IP	621.5nF	B10A=5, B16A=8, C10A=10, C16A=16	872084	901
12V	90 W							x	x	IP		B10A=2, B16A=3, C10A=3, C16A=6	872099	902
12V	100 W							x		basic	842.2nF	B10A=3, B16A=5, C10A=7, C16A=11	862165	901
12V	100 W							x	x	IP	621.5nF	B10A=3, B16A=5, C10A=7, C16A=11	872093	901
12V	100 W							x		long-flat	462.1nF	B10A=3, B16A=5, C10A=7, C16A=11	862125	900
12V	34-100 W	x						x		basic	39.64nF	B10A=3, B16A=5, C10A=7, C16A=11	862091	904
12V	120 W							x	x	IP		B10A=2, B16A=4, C10A=4, C16A=6	872100	902
12V	120 W						x	x	x	IP		B10A=2, B16A=4, C10A=4, C16A=6	872110	910
12V	135 W				x			x		*		B10A=7, B16A=12, C10A=16, C16A=25	843274	911

electr. data		dimmable via						usage / design			electrical limit values		power supply	
voltage	power	leading / trailing edge	1 - 10V	touch dimmer [Push]	DMX	DALI BUS ready	KNX	indoor	outdoor	design	capacitive load	max. quantity per automatic circuit breaker	item number	page
12V	150 W							x		long-flat	462.1nF	B10A=3, B16A=5, C10A=6, C16A=10	862172	900
12V	150 W							x		basic	591.2nF	B10A=2, B16A=4, C10A=6, C16A=9	862167	901
12V	150 W							x	x	IP	621.5nF	B10A=2, B16A=4, C10A=6, C16A=9	872086	901
12V	150 W		x					x	x	IP		B10A=3, B16A=5, C10A=6, C16A=10	872011	906
12V	200 W		x	x		x		x		basic		B10A=3, B16A=5, C10A=5, C16A=9	862160	907 908
12V	66-200 W	x						x	x	IP		B10A=2, B16A=4, C10A=4, C16A=8	872095	904
12V	200 W							x	x	IP	621.5nF	B10A=2, B16A=3, C10A=4, C16A=7	872088	901
24V	4 W							x	x	mini		B10A=59, B16A=94, C10A=123, C16A=197	872128	899
24V	6 W							x		flat	43.5nF	B10A=17, B16A=28, C10A=37, C16A=59	872630	900
24V	12 W							x	x	octo	45.63nF	B10A=35, B16A=56, C10A=74, C16A=118	872041	899
24V	12 W							x		flat	98.59nF	B10A=17, B16A=28, C10A=37, C16A=59	872633	900
24V	20 W							x		flat	192.7nF	B10A=17, B16A=28, C10A=37, C16A=59	872636	900
24V	2,5-25 W	x						x		basic	37.63nF	B10A=35, B16A=56, C10A=74, C16A=118	862052	904
24V	40 W							x		basic	762nF	B10A=11, B16A=18, C10A=24, C16A=39	862163	901
24V	40 W							x	x	IP	626.3nF	B10A=5, B16A=9, C10A=12, C16A=19	872083	901
24V	40 W							x	x	IP		B10A=6, B16A=9, C10A=10, C16A=16	872101	902
24V	40 W			x		x		x		*		B10A=8, B16A=14, C10A=18, C16A=29	843278	908
24V	45 W							x		long-flat	451.2nF	B10A=5, B16A=9, C10A=12, C16A=19	862124	900
24V	12-50 W	x						x		basic	46.13nF	B10A=35, B16A=56, C10A=74, C16A=118	862054	904
24V	50 W							x		flat	604.5nF	B10A=11, B16A=18, C10A=24, C16A=39	862122	900
24V	60 W		x					x				B10A=10, B16A=16, C10A=10, C16A=16	872817	906
24V	60 W							x		long-flat	451.2nF	B10A=5, B16A=9, C10A=12, C16A=19	862094	900
24V	60 W							x	x	IP		B10A=6, B16A=9, C10A=10, C16A=16	872102	902
24V	60 W						x	x	x	IP		B10A=6, B16A=9, C10A=10, C16A=16	872112	910
24V	12-60 W	x						x	x	*			872045	905
24V	75 W							x		basic	760nF	B10A=11, B16A=18, C10A=24, C16A=39	862164	901

electr. data		dimmable via						usage / design			electrical limit values		power supply	
voltage	power	leading / trailing edge	1 - 10V	touch dimmer [Push]	DMX	DALI BUS ready	KNX	indoor	outdoor	design	capacitive load	max. quantity per automatic circuit breaker	item number	page
24V	75 W							x	x	IP	626.3nF	B10A=5, B16A=8, C10A=10, C16A=16	872085	901
24V	90 W							x	x	IP		B10A=2, B16A=3, C10A=3, C16A=6	872103	902
24V	100 W							x		basic	724.2nF	B10A=3, B16A=5, C10A=7, C16A=11	862166	901
24V	34-100 W	x						x		basic	40.1nF	B10A=3, B16A=5, C10A=7, C16A=11	862092	904
24V	100 W							x		long-flat	451.2nF	B10A=3, B16A=5, C10A=7, C16A=11	862126	900
24V	100 W							x	x	IP	626.3nF	B10A=3, B16A=5, C10A=7, C16A=11	872094	901
24V	120 W							x	x	IP		B10A=2, B16A=4, C10A=4, C16A=6	872104	902
24V	120 W						x	x	x	IP		B10A=2, B16A=4, C10A=4, C16A=6	872113	910
24V	135 W				x			x		*		B10A=7, B16A=12, C10A=16, C16A=25	843275	911
24V	150 W							x		basic	591.2nF	B10A=2, B16A=4, C10A=6, C16A=9	862168	901
24V	150 W							x		long-flat	451.2nF	B10A=3, B16A=5, C10A=6, C16A=10	862173	900
24V	150 W							x	x	IP	626.3nF	B10A=2, B16A=4, C10A=6, C16A=9	872087	901
24V	30-150 W	x						x	x	*			872046	905
24V	200 W		x	x		x		x		basic		B10A=4, B16A=6, C10A=7, C16A=12	862161	907 908
24V	66-200 W	x						x	x	IP	145.15nF	B10A=2, B16A=4, C10A=4, C16A=8	872096	904
24V	240 W							x	x	IP	626.3nF	B10A=2, B16A=3, C10A=4, C16A=7	872089	901
24V	320 W							x	x	IP	626.3nF	B10A=2, B16A=3, C10A=4, C16A=6	872091	901
48V	40 W							x	x	IP		B10A=6, B16A=9, C10A=10, C16A=16	872105	902
48V	60 W							x	x	IP		B10A=6, B16A=9, C10A=10, C16A=16	872106	902
48V	75 W							x	x	IP		B10A=4, B16A=7, C10A=7, C16A=11	872116	902
48V	75 W		x					x	x	IP		B10A=4, B16A=7, C10A=7, C16A=11	872117	907
48V	75 W					x		x	x	IP		B10A=4, B16A=7, C10A=7, C16A=11	872118	909
48V	90 W							x	x	IP		B10A=2, B16A=3, C10A=3, C16A=6	872107	902
48V	120 W							x	x	IP		B10A=2, B16A=4, C10A=4, C16A=6	872108	902
48V	150 W							x	x	IP		B10A=2, B16A=3, C10A=3, C16A=5	872119	902
48V	150 W		x					x	x	IP		B10A=2, B16A=3, C10A=3, C16A=5	872120	907

electr. data		dimmable via						usage / design			electrical limit values		power supply	
voltage	power	leading / trailing edge	1 - 10V	touch dimmer [Push]	DMX	DALI BUS ready	KNX	indoor	outdoor	design	capacitive load	max. quantity per automatic circuit breaker	item number	page
48V	150 W					x		x	x	IP		B10A=2, B16A=3, C10A=3, C16A=5	872121	909
48V	240 W							x	x	IP		B10A=2, B16A=4, C10A=4, C16A=6	872122	902
48V	240 W		x					x	x	IP		B10A=2, B16A=4, C10A=4, C16A=6	872123	907
48V	240 W					x		x	x	IP		B10A=2, B16A=4, C10A=4, C16A=6	872124	909
48V	600 W							x	x	IP		B10A=1, B16A=1, C10A=1, C16A=2	872125	902
48V	600 W		x					x	x	IP		B10A=1, B16A=1, C10A=1, C16A=2	872126	907

power supplies design



mini



round / octo



flat



basic



long-flat



IP

* special design

DEKO-LIGHT POWER SUPPLIES | DESIGN MINI

- plastic housing
- suitable for indoor and outdoor use
- flicker free
- short-circuit proof and overload protection



872127	■	12V	4W	0-330mA	5A/260μs	38 x 27 x 21 mm	11,95 €	new
872128	■	24V	4W	0-170 mA	5A/260μs	38 x 27 x 21 mm	11,95 €	new



DEKO-LIGHT POWER SUPPLIES | DESIGN OCTO

- plastic housing
- suitable for indoor and outdoor use
- short-circuit proof and overload protection



872040	■	12V	12W	0-1000mA	3A/300μs	50 x 48 x 24 mm	20,95 €
872041	■	24V	12W	0-500mA	3A/300μs	50 x 48 x 24 mm	20,95 €



DEKO-LIGHT POWER SUPPLIES | DESIGN FLAT

- plastic housing
- suitable for indoor use
- flicker free
- short-circuit proof and overload protection
- overheat control



design example

872629	■	12V	6W	0-500mA	7A/300µs	98 x 46 x 11 mm	16,95 €
872632	■	12V	12W	0-1000mA	8A/300µs	128 x 50 x 13 mm	19,95 €
872635	■	12V	20W	0-1670mA	12A/300µs	128 x 50 x 14 mm	22,95 €
862121	■	12V	50W	0-4160mA	15A/300µs	185 x 62 x 22 mm	54,95 €
872630	■	24V	6W	0-250mA	7A/300µs	98 x 46 x 11 mm	16,95 €
872633	■	24V	12W	0-500mA	8A/300µs	128 x 50 x 13 mm	19,95 €
872636	■	24V	20W	0-830mA	12A/300µs	128 x 50 x 14 mm	22,95 €
862122	■	24V	50W	0-2100mA	15A/300µs	185 x 62 x 22 mm	54,95 €



DEKO-LIGHT POWER SUPPLIES | DESIGN LONG-FLAT

design example

- plastic housing
- suitable for indoor use
- ideal for concealed mounting in ceiling coving
- flicker free
- short-circuit proof and overload protection
- overheat control

862123	■	12V	45W	0-3750mA	30A/300µs	251 x 30 x 16 mm	49,95 €
862093	□	12V	60W	0-5000mA	30A/300µs	305 x 30 x 17 mm	59,95 €
862125	■	12V	100W	0-8340mA	50A/300µs	312 x 30 x 18 mm	96,95 €
862172	■	12V	150W	0-12500mA	60A/300µs	335 x 30 x 22 mm	134,95 €
862124	■	24V	45W	0-1870mA	30A/300µs	251 x 30 x 16 mm	49,95 €
862094	□	24V	60W	0-2500mA	30A/300µs	305 x 30 x 17 mm	59,95 €
862126	■	24V	100W	0-4170mA	50A/300µs	312 x 30 x 18 mm	96,95 €
862173	■	24V	150W	0-6250mA	60A/300µs	335 x 30 x 22 mm	134,95 €



DEKO-LIGHT POWER SUPPLIES | DESIGN BASIC

- plastic housing
- suitable for indoor use
- flicker free
- short-circuit proof and overload protection
- overheat control



design example

862162	■	12V	40W	0-3000 mA	15A/300µs	166 x 52 x 24 mm	48,95 €	
862127	■	12V	75W	0-6300 mA	15A/300µs	184 x 61 x 32 mm	74,95 €	
862165	■	12V	100W	0-8300 mA	50A/300µs	184 x 61 x 32 mm	94,95 €	new
862167	■	12V	150W	0-12500 mA	60A/300µs	210 x 67 x 34 mm	129,95 €	
862163	■	24V	40W	0-1700 mA	15A/300µs	166 x 52 x 24 mm	48,95 €	
862164	■	24V	75W	0-3100 mA	15A/300µs	184 x 61 x 32 mm	74,95 €	
862166	■	24V	100W	0-4200 mA	50A/300µs	184 x 61 x 32 mm	94,95 €	
862168	■	24V	150W	0-6250 mA	60A/300µs	210 x 67 x 34 mm	129,95 €	



DEKO-LIGHT POWER SUPPLIES | DESIGN IP

- aluminium housing
- suitable for indoor and outdoor use
- flicker free
- short-circuit proof and overload protection
- overheat control



design example

872082	■	12V	40W	0-3340 mA	30A/300µs	182 x 58 x 30,5 mm	69,95 €	
872084	■	12V	75W	0-6250 mA	35A/300µs	186 x 64 x 39 mm	89,95 €	
872093	■	12V	100W	0-8340 mA	50A/300µs	186 x 64 x 39 mm	109,95 €	
872086	■	12V	150W	0-12500 mA	60A/300µs	191 x 70 x 40 mm	149,95 €	
872088	■	12V	200W	0-16600 mA	75A/300µs	249 x 72 x 41 mm	165,95 €	
872083	■	24V	40W	0-1670 mA	30A/300µs	182 x 58 x 30,5 mm	69,95 €	
872085	■	24V	75W	0-3125 mA	35A/300µs	199 x 67 x 35 mm	89,95 €	
872094	■	24V	100W	0-4170 mA	50A/300µs	186 x 64 x 39 mm	109,95 €	
872087	■	24V	150W	0-6250 mA	60A/300µs	191 x 70 x 40 mm	149,95 €	
872089	■	24V	240W	0-10000 mA	75A/300µs	249 x 72 x 41 mm	179,95 €	
872091	■	24V	320W	0-13340 mA	85A/300µs	252 x 90 x 44 mm	209,95 €	





design example

MEANWELL POWER SUPPLIES NPF-SERIES

- plastic housing
- suitable for indoor and outdoor use
- flicker free
- short-circuit proof and overload protection
- overheat control

872097	■	12V	40W	0-3340mA	50A/270µs	150 x 53 x 35 mm	69,95 €	new
872098	■	12V	60W	0-5000mA	50A/270µs	150 x 53 x 35 mm	74,95 €	new
872099	■	12V	90W	0-7500mA	60A/550µs	171 x 63 x 38 mm	94,95 €	new
872100	■	12V	120W	0-10000mA	60A/520µs	191 x 63 x 38 mm	119,95 €	new
872101	■	24V	40W	0-1670mA	50A/270µs	150 x 53 x 35 mm	69,95 €	new
872102	■	24V	60W	0-2500mA	50A/270µs	150 x 53 x 35 mm	74,95 €	new
872103	■	24V	90W	0-3750mA	60A/550µs	171 x 63 x 38 mm	94,95 €	new
872104	■	24V	120W	0-5000mA	60A/520µs	191 x 63 x 38 mm	119,95 €	new
872105	■	48V	40W	0-840mA	50A/270µs	150 x 53 x 35 mm	69,95 €	new
872106	■	48V	60W	0-1250mA	50A/270µs	150 x 53 x 35 mm	74,95 €	new
872107	■	48V	90W	0-1880mA	60A/550µs	171 x 63 x 38 mm	94,95 €	new
872108	■	48V	120W	0-2500mA	60A/520µs	191 x 63 x 38 mm	119,95 €	new



MEANWELL POWER SUPPLIES ELG/HLG-SERIES

- aluminium housing
- suitable for indoor and outdoor use
- flicker free
- short-circuit proof and overload protection
- overheat control
- output voltage/current adjustable/dimmable via int. potentiometers



design example

872116	□	ELG	48V	75W	0-1600mA	50A/350µs	180 x 63 x 36 mm	84,95 €	new
872119	□	ELG	48V	150W	0-3130mA	65A/550µs	219 x 63 x 36 mm	149,95 €	new
872122	□	ELG	48V	240W	0-5000mA	60A/510µs	244 x 71 x 38 mm	179,95 €	new
872125	□	HLG	48V	600W	0-12500mA	70A/1000µs	280 x 144 x 49 mm	429,95 €	new





DEKO-LIGHT POWER SUPPLIES | DESIGN BASIC PRIMARY DIMMABLE

- plastic housing
- suitable for indoor use
- ideal for upgrade existing installations, as primarily with commercially rotary [C-capable, via phase angle or section] dimmable
- cannot be combined with PWM dimmers such as RF, DMX, DALI or KNX
- short-circuit proof and overload protection
- overheat control



design example

862051	■	12V	2,5 - 25W	5A/300µs	122 x 52 x 30 mm	56,95 €
862053	■	12V	12,0 - 50W	5A/300µs	184 x 61 x 33 mm	76,95 €
862091	□	12V	34,0 - 100W	50A/300µs	210 x 67 x 34 mm	146,95 €
862052	■	24V	2,5 - 25W	5A/300µs	122 x 52 x 30 mm	56,95 €
862054	■	24V	12,0 - 50W	5A/300µs	184 x 61 x 33 mm	76,95 €
862092	□	24V	34,0 - 100W	50A/300µs	210 x 67 x 34 mm	146,95 €



DEKO-LIGHT POWER SUPPLIES | DESIGN IP PRIMARY DIMMABLE

- metal housing
- suitable for indoor and outdoor use
- ideal for upgrade existing installations, as primarily with commercially rotary [C-capable, via phase angle or section] dimmable
- cannot be combined with PWM dimmers such as RF, DMX, DALI or KNX
- short-circuit proof and overload protection
- overheat control



872095	□	12V	66 - 200W	75A/300µs	249 x 72 x 40 mm	206,95 €
872096	□	24V	66 - 200W	75A/300µs	249 x 72 x 40 mm	206,95 €



ABN SAFETY ISOLATING TRANSFORMER [DC] ACCORDING TO DIN EN 61558-1 PRIMARY DIMMABLE

A safety transformer requires stronger or double insulation and stricter checks apply. It is therefore suitable for applications according to DIN EN 61558 in the area of increased personal protection, e. g. for the operation of luminaires which are installed in swimming pools, fountains, wet cells or similar.



design example

LED SICHERHEITSTRANSFORMATOR

- dimmable via leading edge
- maximum load: 80% continuous operation
- suitable for indoor and outdoor use

872045	■	24V	12 - 60W	150 x 90 x 70 mm	299,95 €
872046	■	24V	30 - 150W	176 x 116 x 110 mm	399,95 €



With the kind support of Loxone Lichtinstallation Eurotec-Ibiza | Foto: fotoeichhorn





DEKO-LIGHT POWER SUPPLIES | DESIGN IP

- aluminium housing
- suitable for indoor and outdoor use
- short-circuit proof and overload protection
- overheat control
- dimmable via 1 - 10V

872011 12V 150W 0-12500mA 60A/300µs 223 x 70 x 40 mm **154,95 €**



HEP POWER SUPPLY LAV60W24V1C

- metal housing
- suitable for indoor use
- short-circuit proof and overload protection
- overheat control
- 1 - 10V dimmbar

872817 24V 60W 0-2500 mA 37,4A/171µs 280 x 30 x 27,5 mm **84,95 €**





design example

MEANWELL POWER SUPPLIES ELG/HLG-SERIES

- aluminium housing
- suitable for indoor and outdoor use
- flicker free
- short-circuit proof and overload protection
- overheat control
- dimmable via 0-10V / 1-10V

872117	<input type="checkbox"/>	ELG	48V	75W	0-1600mA	50A/350µs	180 x 63 x 36 mm	94,95 €	new
872120	<input type="checkbox"/>	ELG	48V	150W	0-3130mA	65A/550µs	219 x 63 x 36 mm	154,95 €	new
872123	<input type="checkbox"/>	ELG	48V	240W	0-5000mA	60A/510µs	244 x 71 x 38 mm	169,95 €	new
862126	<input type="checkbox"/>	HLG	48V	600W	0-12500mA	70A/1000µs	280 x 144 x 49 mm	439,95 €	new



DEKO-LIGHT POWER SUPPLIES | DESIGN BASIC

- aluminium housing
- suitable for indoor use
- short-circuit proof and overload protection
- overheat control
- dimmable via 0-10V / 1-10V, Touch-Dim [Push] or DALI-Bus according to IEC 62386

862160	<input checked="" type="checkbox"/>	12V	200W	0-16700 mA	28A/1250µs	310 x 60 x 45 mm	189,95 €
862161	<input checked="" type="checkbox"/>	24V	200W	0-8300 mA	27A/650µs	310 x 60 x 45 mm	189,95 €





DEKO-LIGHT POWER SUPPLIES DALI DCV

- plastic housing
- suitable for indoor use
- short-circuit proof and overload protection
- overheat control
- Dali Bus ready according to IEC 62386
- supports touch dimmer function [Push]
- soft dimming without flickering

843277 □ 12V 40W 0-3400mA 20A/350µs 122 x 78 x 32 mm **99,95 €**

843278 □ 24V 40W 0-1700mA 20A/350µs 122 x 78 x 32 mm **99,95 €**

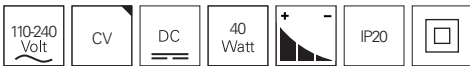

DEKO-LIGHT POWER SUPPLIES DALI | DESIGN BASIC

- aluminium housing
- suitable for indoor use
- short-circuit proof and overload protection
- overheat control
- dimmable via DALI-Bus nach IEC 62386, 0-10V / 1-10V or Touch-Dim [Push]

862160 ■ 12V 200W 0-16700 mA 310 x 60 x 45 mm **189,95 €**

862161 ■ 24V 200W 0-8300 mA 310 x 60 x 45 mm **189,95 €**





design example

MEANWELL POWER SUPPLIES ELG-DALI-SERIES

- aluminium housing
- suitable for indoor and outdoor use
- flicker free
- short-circuit proof and overload protection
- overheat control
- dimmable via DALI-Bus nach IEC 62386

872118	<input type="checkbox"/>	48V	75W	0-1600mA	50A/350µs	180 x 63 x 36 mm	99,95 €	new
872121	<input type="checkbox"/>	48V	150W	0-3130mA	65A/550µs	219 x 63 x 36 mm	159,95 €	new
872124	<input type="checkbox"/>	48V	240W	0-5000mA	60A/510µs	244 x 71 x 38 mm	174,95 €	new





MEANWELL POWER SUPPLIES PWM KNX-SERIES

- plastic housing
- suitable for indoor and outdoor use
- flicker free
- short-circuit proof and overload protection
- overheat control
- dimmable via KNX-Bus

872109	■	12V	60W	0-5000mA	50A/270µs	150 x 53 x 35 mm	149,95 €	new
872110	■	12V	120W	0-10000mA	60A/520µs	191 x 63 x 38 mm	189,95 €	new
872112	■	24V	60W	0-2500mA	50A/270µs	150 x 53 x 35 mm	149,95 €	new
872113	■	24V	120W	0-5000mA	60A/520µs	191 x 63 x 38 mm	189,95 €	new



DEKO-LIGHT POWER SUPPLIES HV DMX 135W

Easy to install and compact DMX unit. A powerful 3 channel dimmer and a 135 Watt power supply are combined in one housing. This makes installation quick and easy. Controllable with all 3 channel control panels and DMX Controllers.



- aluminium housing
- suitable for indoor use
- short-circuit proof and overload protection
- supported DMX 512
- dimmable from 0 - 100%
- soft dimming without flickering
- with integrated 3-channel DMX dimmer

843274	■	12V	135W	0-11250 mA	23A/320µs	196 x 75 x 40 mm	159,95 €
843275	■	24V	135W	0-5630 mA	23A/320µs	196 x 75 x 40 mm	159,95 €

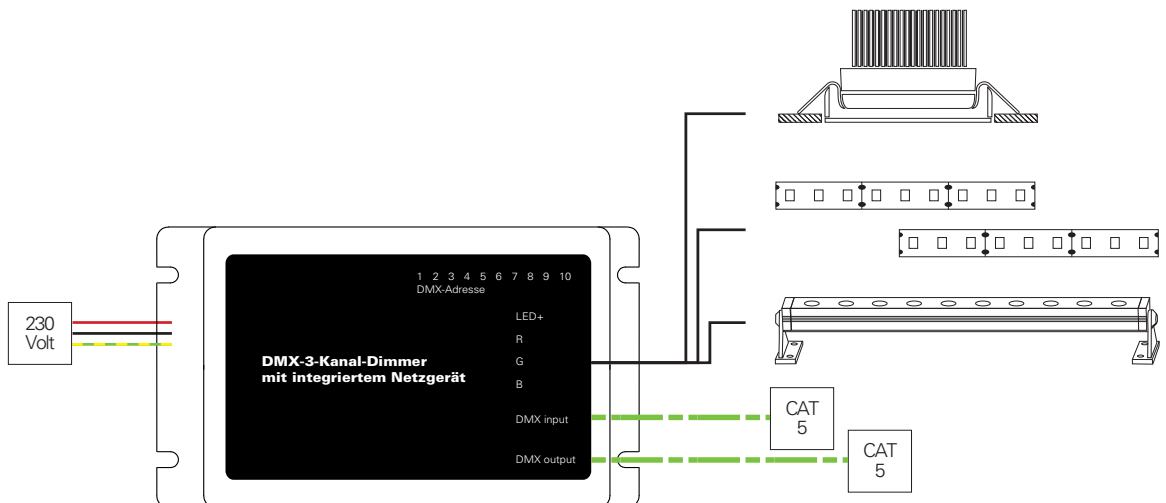

electr. data			dimmable via					usage /design			electrical limit values		power supply	
current	power	voltage	leading / trailing edge	1 - 10V	touch dimmer [Push]	DALI BUS ready	KNX	indoor	outdoor	design	capacitive load	max. quantity per automatic circuit breaker	item number	page
350 mA	1,1-4,0 W	3-12V						x	x	mini	14.32pF	B10A=17, B16A=28, C10A=37, C16A=59	872026	915
350 mA	2,1-4,0 W	6-12V	x					x	x	mini	4.75nF	B10A=35, B16A=56, C10A=74, C16A=118	872013	919
350 mA	0,7-6,0 W	2-18V						x		flat	40.44nF	B10A=17, B16A=28, C10A=37, C16A=59	872628	916
350 mA	3,2-8,0 W	9-23V						x		round	200uF	B10A=17, B16A=28, C10A=37, C16A=59	862212	915
350 mA	3,9-9,0 W	11-26V	x					x		basic		B10A=17, B16A=28, C10A=37, C16A=59	862202	920
350 mA	6,0-9,0 W	17,1-25,7V						x		mini		B10A=64, B16A=103, C10A=64, C16A=103	872818	915
350 mA	6,3-12,0 W	18-35V	x					x		basic	46.72pF	B10A=35, B16A=56, C10A=74, C16A=118	872643	920
350 mA	0,7-12,0 W	2-35V						x		flat	187.2nF	B10A=17, B16A=28, C10A=37, C16A=59	872631	916
350 mA	6,3-12,0 W	18-35V	x					x	x	octo	39.34pF	B10A=35, B16A=56, C10A=74, C16A=118	862031	919
350 mA	8,8-14,7 W	25-42V	x					x		basic		B10A=29, B16A=47, C10A=29, C16A=47	862142	920
350 mA	0,7-18,0 W	2-52V						x		basic	147nF	B10A=17, B16A=28, C10A=37, C16A=59	180512	917
350 mA	9,8-20,0 W	28-57V	x					x		basic		B10A=11, B16A=18, C10A=24, C16A=39	862204	920
350 mA	0,7-20,0 W	2-57V						x		flat	93.04nF	B10A=11, B16A=18, C10A=24, C16A=39	872634	916
500 mA	1,0-4,0 W	2-8V						x	x	mini	19.8pF	B10A=17, B16A=28, C10A=37, C16A=59	872065	915
500 mA	2,0-4,0 W	4-8V	x					x	x	mini	4.75nF	B10A=35, B16A=56, C10A=74, C16A=118	872014	919
500 mA	1,0-6,0 W	2-12V						x		flat	38.48nF	B10A=17, B16A=28, C10A=37, C16A=59	862130	916
500 mA	3,0-8,0 W	6-16V						x		round	62.96nF	B10A=11, B16A=18, C10A=24, C16A=39	862128	915
500 mA	1,0-12,0 W	2-24V						x		flat	190.7nF	B10A=17, B16A=28, C10A=37, C16A=59	862131	916
500 mA	6,0-9,0 W	12-18V						x		mini		B10A=64, B16A=103, C10A=64, C16A=103	872826	915
500 mA	6,0-12,0 W	12-24V	x					x	x	octo	37.36pF	B10A=35, B16A=56, C10A=74, C16A=118	862030	919
500 mA	1,0-18,0 W	2-38V						x		basic	147nF	B10A=17, B16A=28, C10A=37, C16A=59	180513	917
500 mA	1,0-20,0 W	2-40V						x		flat	192.6nF	B10A=11, B16A=18, C10A=24, C16A=39	862132	916
500 mA	10,0-20,0 W	20-40V	x					x		basic		B10A=11, B16A=18, C10A=24, C16A=39	862205	920
500 mA	10,0-30,0 W	20-60V						x		basic	29.84nF	B10A=35, B16A=56, C10A=74, C16A=118	872665	917
500 mA	13,5-40,0 W	27-80V						x		basic	183.9nF	B10A=35, B16A=56, C10A=74, C16A=118	862134	917
500 mA	20,0-40,0 W	40-80V	x					x		basic	29.84nF	B10A=35, B16A=56, C10A=74, C16A=118	862136	920

electr. data			dimmable via					usage /design			electrical limit values		power supply	
current	power	voltage	leading / trailing edge	1 - 10V	touch dimmer [Push]	DALI BUS ready	KNX	indoor	outdoor	design	capacitive load	max. quantity per automatic circuit breaker	item number	page
700 mA	1,4-4,0 W	2-6V						x	x	mini	16.65pF	B10A=17, B16A=28, C10A=37, C16A=59	872027	915
700 mA	2,1-4,0 W	3-6V	x					x	x	mini	4.71nF	B10A=35, B16A=56, C10A=74, C16A=118	872015	919
700 mA	1,4-6,0 W	2-9V						x		flat	40.44nF	B10A=17, B16A=28, C10A=37, C16A=59	862048	916
700 mA	4,2-8,0 W	6-12V						x		round	46.24nF	B10A=11, B16A=18, C10A=24, C16A=39	862129	915
700 mA	1,4-12,0 W	2-19V						x		flat	190.7nF	B10A=17, B16A=28, C10A=37, C16A=59	862049	916
700 mA	6,3-12,0 W	9-18V	x					x	x	octo	513.8pF	B10A=35, B16A=56, C10A=74, C16A=118	862032	919
700 mA	1,4-18,0 W	2-26V						x		basic	147nF	B10A=17, B16A=28, C10A=37, C16A=59	180514	917
700 mA	1,4-20,0 W	2-31V						x		flat	192.6nF	B10A=11, B16A=18, C10A=24, C16A=39	862050	916
700 mA	9,8-20,0 W	14-28V	x					x		basic		B10A=11, B16A=18, C10A=24, C16A=39	862207	920
700 mA	9,1-30,0 W	13-43V						x		basic		B10A=11, B16A=18, C10A=24, C16A=39	862198	917
700 mA	10,5-35,0 W	15-50V						x		*		B10A=3, B16A=5, C10A=6, C16A=9	872641	917
700 mA	14,0-40,0 W	20-57V						x		basic	230.6nF	B10A=35, B16A=56, C10A=74, C16A=118	862135	917
700 mA	19,6-40,0 W	28-56V	x					x		basic		B10A=35, B16A=56, C10A=74, C16A=118	862208	920
900mA	19,8-40,0 W	22-44V						x		basic	13.5pF	B10A=8, B16A=14, C10A=18, C16A=29	862157	917
1050 mA	9,8-22,0 W	9-20V	x					x		basic	40.72pF	B10A=11, B16A=18, C10A=24, C16A=39	872647	920
1050 mA	9,5-90,0 W	9-28V						x		basic	27.9nF	B10A=35, B16A=56, C10A=74, C16A=118	862133	917
1050 mA	20,0-40,0 W	19-38V						x		basic		B10A=8, B16A=14, C10A=18, C16A=29	862201	917
1050 mA	20,0-40,0 W	19-38V	x					x		basic		B10A=140, B16A=224, C10A=280, C16A=440	862209	920
1050 mA	23,5-45,0 W	22-43V						x		basic	30.43nF	B10A=35, B16A=56, C10A=74, C16A=118	862154	920
1300 mA	26,0-50,0 W	20-39V	x					x		basic		B10A=140, B16A=224, C10A=280, C16A=440	862211	920
1400 mA	19,6-40,0 W	14-28V	x					x		basic	20.8nF	B10A=35, B16A=56, C10A=74, C16A=118	862138	920

power supplies design

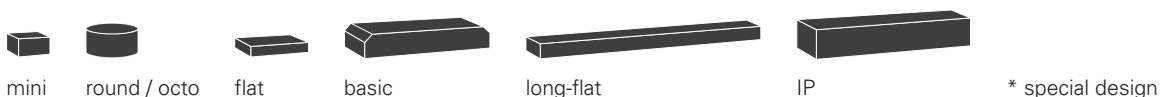

electr. data			dimmable via					usage /design			electrical limit values		power supply	
current	power	voltage	leading / trailing edge	1 - 10V	touch dimmer [Push]	DALI BUS ready	KNX	indoor	outdoor design	capacitive load	max. quantity per automatic circuit breaker	item number	page	
MULTI*	3,2-20,0 W	9-40V	x					x	basic		B10A=46, B16A=74, C10A=93, C16A=149	862141	921	
MULTI*	3,2-12,0 W	15-54V			x	x		x	basic		B10A=23, B16A=37, C10A=46, C16A=74	862190	923	
MULTI*	5,0-25,0 W	20-60V			x	x		x	basic		B10A=23, B16A=37, C10A=46, C16A=74	862191	923	
MULTI*	8,75-45,0 W	21-70V			x	x		x	basic		B10A=12, B16A=20, C10A=25, C16A=40	862192	923	
MULTI*	14,7-45,0 W	14-43V			x	x		x	basic		B10A=12, B16A=20, C10A=25, C16A=40	862193	923	
MULTI*	26,3-75,5 W	25-71V			x	x		x	basic		B10A=3, B16A=5, C10A=6, C16A=10	862194	923	
MULTI*	2,1-25,2 W	6-54V			x	x		x	*		B10A=16, B16A=26, C10A=27, C16A=44	862012	924	
MULTI*	0,70 - 42,00 W	2-100V			x	x		x	*		B10A=16, B16A=26, C10A=27, C16A=44	862013	924	
MULTI*	1,0-60,3 W	2-90V			x	x		x	*		B10A=15, B16A=25, C10A=20, C16A=32	862014	924	
MULTI*	2,1-25,2 W	6-54V			x		x	x	*		B10A=16, B16A=26, C10A=27, C16A=44	862174	925	
MULTI*	0,7-42,0 W	2-100V			x		x	x	*		B10A=16, B16A=26, C10A=27, C16A=44	862175	925	
MULTI*	1,0-60,3 W	2-90V			x		x	x	*		B10A=15, B16A=25, C10A=20, C16A=32	862176	925	

* Due to the large number of possible settings, please refer to the detailed technical data on the specified product page.

TIPS AND TRICKS FOR CURRENT-STABLE POWER SUPPLIES

In contrast to voltage-stable power supplies [CV] and as the name suggests, the output current of current-stable power supplies, often abbreviated CC [constant current], is stable. This means that the power supply unit limits the output current [e.g. 350 mA, 700 mA etc.] accordingly and adapts the voltage to the LED within the specified voltage range. From this circumstance some important factors result, which must be absolutely considered during planning and installation.

- Do not connect the LED to CC power supplies while they are live, as this may damage them and cause them to fail after a short period of operation.
- if necessary: operate max. 2 lamps in a series connection on one power supply unit
However, the voltage range and the power of the power supply unit must be checked for this purpose, as voltages are split due to the laws of series connection.
- If an LED light [CC] is too bright and you want to dim it permanently without having to install additional components, then simply use a lower current of a compatible power supply. Please also observe our note on the respective power supply units.
- if possible: 1 lamp = 1 power supply unit

Netzgerätedaten prüfen! Check driver data!

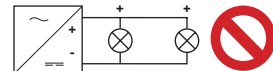
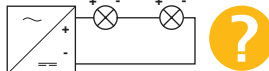
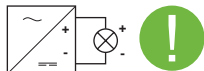

Installationshinweis für Netzgerät stromstabil [CC]: LED nicht unter Spannung anschließen!
installation instruction for power supply constant current [CC]: Don't connect LED under voltage!

DEKO-LIGHT POWER SUPPLIES | DESIGN MINI

- plastic housing
- suitable for indoor and outdoor use
- short-circuit proof and overload protection



872026	■	350mA	1,10-4,00W	3-12V	10A/300µs	38 x 27 x 21 mm	11,95 €
872065	■	500mA	1,00-4,00W	2-8V	10A/300µs	38 x 27 x 21 mm	11,95 €
872027	■	700mA	1,40-4,00W	2-6V	10A/300µs	38 x 27 x 21 mm	11,95 €



DEKO-LIGHT POWER SUPPLIES | DESIGN ROUND

- plastic housing
- suitable for indoor use
- short-circuit proof and overload protection



862212	■	350mA	3,20-8,00W	9-23V	10A/300µs	53 x 22 mm	19,95 € new
862128	■	500mA	3,00-8,00W	6-16V	8A/300µs	53 x 22 mm	19,95 €
862129	■	700mA	4,20-8,00W	6-12V	8A/300µs	53 x 22 mm	19,95 €





design example

DEKO-LIGHT POWER SUPPLIES | DESIGN FLAT

- plastic housing
- suitable for indoor use
- flicker free
- short-circuit proof and overload protection

872628	■	350mA	0,70-6,00W	2-18V	10A/300µs	98 x 46 x 11 mm	17,95 €
872631	■	350mA	0,70-12,00W	2-35V	12A/300µs	128 x 50 x 13 mm	21,95 €
872634	■	350mA	0,70-20,00W	2-57V	15A/300µs	154 x 50 x 14 mm	24,95 €
862130	■	500mA	1,00-6,00W	2-12V	10A/300µs	98 x 46 x 11 mm	17,95 €
862131	■	500mA	1,00-12,00W	2-24V	12A/300µs	128 x 50 x 13 mm	21,95 €
862132	■	500mA	1,00-20,00W	2-40V	15A/300µs	154 x 50 x 14 mm	24,95 €
862048	■	700mA	1,40-6,00W	2-9V	10A/300µs	98 x 46 x 11 mm	17,95 €
862049	■	700mA	1,40-12,00W	2-19V	12A/300µs	128 x 50 x 14 mm	21,95 €
862050	■	700mA	1,40-20,00W	2-31V	15A/300µs	128 x 50 x 14 mm	24,95 €



HEP POWER SUPPLIES LIC/LIVC-SERIE

- suitable for indoor use

872818	□	350mA	6,00-9,00W	17,1 - 25,7V	66A/0,9µs	58,1 x 39 x 20 mm	21,95 €
872826	□	500mA	6,00-9,00W	12 - 18V	68A/1,0µs	58,1 x 39 x 20 mm	21,95 €





design example

DEKO-LIGHT POWER SUPPLIES | DESIGN BASIC

- plastic housing
- suitable for indoor use
- flicker free
- short-circuit proof and overload protection

180512	■	350mA	0,70-18,00W	2-52V	10A/300µs	115 x 45 x 21 mm	23,95 €
180513	■	500mA	1,00-18,00W	2-38V	10A/300µs	115 x 45 x 21 mm	23,95 €
872665	■	500mA	10,00-30,00W	20-60V	5A/300µs	128 x 50 x 13 mm	25,95 €
862134	■	500mA	13,50-40,00W	27-80V	5A/300µs	154 x 50 x 14 mm	29,95 €
180514	■	700mA	1,40-18,00W	2-26V	10A/300µs	115 x 45 x 21 mm	23,95 €
862198	■	700mA	9,10-30,00W	13-43V	8A/300µs	142 x 50 x 24 mm	25,95 € new
862135	■	700mA	14,00-40,00W	20-57V	5A/300µs	142 x 50 x 24 mm	29,95 €
862157	■	900mA	19,80-40,00 W	22-44V	20A/300µs	127 x 43 x 28 mm	29,95 €
862133	■	1050mA	9,50-30,00W	9-28V	5A/300µs	142 x 50 x 24 mm	25,95 €
862201	■	1050mA	12,60-40,00W	12-38V	20A/300µs	142 x 50 x 24 mm	29,95 € new



MEAN WELL POWER SUPPLY APC-SERIE

- suitable for indoor use

872641	□	700mA	10,50-35,00W	15 - 50V	45A/490µs	84 x 57 x 29,5 mm	37,95 €
---------------	---	-------	--------------	----------	-----------	-------------------	----------------

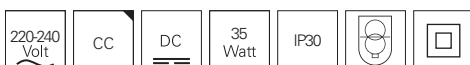



DEKO-LIGHT POWER SUPPLIES | DESIGN MINI

- plastic housing
- suitable for indoor and outdoor use
- short-circuit proof and overload protection
- dimmable with compatible [C-compatible] trailing or leading edge phase dimmers



872013	□	350mA	2,10-4,00W	6-12V	5A/300μs	53,35 x 27 x 21 mm	17,95 €
872014	□	500mA	2,00-4,00W	4-8V	5A/300μs	53,35 x 27 x 21 mm	17,95 €
872015	□	700mA	2,10-4,00W	3-6V	5A/300μs	53,35 x 27 x 21 mm	17,95 €



DEKO-LIGHT POWER SUPPLIES | DESIGN OCTO

- plastic housing
- suitable for indoor and outdoor use
- short-circuit proof and overload protection
- dimmable with compatible [C-compatible] trailing or leading edge phase dimmers



862031	■	350mA	6,30-12,00W	18-35V	5A/300μs	50 x 48 x 24 mm	29,95 €
862030	■	500mA	6,00-12,00W	12-24V	5A/300μs	50 x 48 x 24 mm	29,95 €
862032	■	700mA	6,30-12,00W	9-18V	5A/300μs	50 x 48 x 24 mm	29,95 €



DEKO-LIGHT POWER SUPPLIES | DESIGN BASIC

- plastic housing
- suitable for indoor use
- short-circuit proof and overload protection
- overheat control
- dimmable with compatible [C-compatible] trailing or leading edge phase dimmers



862202	■	350mA	3,90-9,00W	11- 26V	10A/300µs	115 x 39 x 22 mm	28,95 €	new
872643	■	350mA	6,30-12,00W	18-35V	5A/300µs	115 x 39 x 22 mm	34,95 €	
862204	■	350mA	9,80-20,00W	28,57V	15A/300µs	127 x 44 x 28 mm	39,95 €	new
862205	■	500mA	10,00-20,00W	20-40V	15A/300µs	127 x 44 x 28 mm	42,95 €	new
862136	■	500mA	20,00-40,00W	40-80V	5A/300µs	166 x 52 x 24 mm	49,95 €	
862207	■	700mA	9,80-20,00W	14-28V	15A/300µs	127 x 44 x 28 mm	42,95 €	new
862208	■	700mA	19,60-40,00W	28-56V	5A/300µs	166 x 52 x 24 mm	49,95 €	new
872647	■	1050mA	9,80-22,00W	9-20V	15A/300µs	127 x 44 x 28 mm	39,95 €	
862209	■	1050mA	20,00-40,00W	19-38V	5A/300µs	166 x 52 x 25 mm	49,95 €	new
862154	■	1050mA	23,50-45,00W	22-43V	5A/300µs	166 x 52 x 24 mm	54,95 €	
862211	■	1300mA	26,00-50,00W	20-39V	5A/300µs	166 x 52 x 25 mm	61,95 €	new
862138	■	1400mA	19,60-40,00W	14-28V	5A/300µs	166 x 52 x 24 mm	49,95 €	



HEP NETZGERÄT LMTC15W350LR-Z

- dimmable via leading or trailing edge
- suitable for indoor use

862142	□	350mA	8,80-14,70W	25 - 42V	15A/28µs	115 x 40,4 x 25 mm	32,95 €	new
---------------	---	-------	-------------	----------	----------	--------------------	----------------	------------



DEKO-LIGHT POWER SUPPLY | BASIC MULTI-CURRENT

- plastic housing
- suitable for indoor use
- flicker free
- short-circuit proof and overload protection
- current range adjustable
- dimmable with compatible [C-compatible] trailing or leading edge phase dimmers



862141	<input type="checkbox"/>	350mA	3,20 - 14,00W	9-40V	15A/90µs	150 x 43 x 28 mm	41,95 €
		400mA	3,60 - 16,00W	9-40V			
		450mA	4,00 - 18,00W	9-40V			
		500mA	4,50 - 20,00W	9-40V			
		550mA	5,00 - 19,80W	9-36V			
		600mA	5,40 - 19,80W	9-33V			
		650mA	5,90 - 19,50W	9-30V			
		700mA	6,30 - 19,60W	9-28V			



BASIC INFORMATION ON THE USE OF DALI BALLASTS

DALI SINGLE DIMMER

DALI single dimmers cannot be integrated into existing DALI networks. The control takes place via so-called single dimmers, which generate their own control signal.

DALI BUS READY

These components can be integrated and controlled in existing DALI BUS systems that comply with the IEC 62386 protocol.

DEKO-LIGHT POWER SUPPLY | BASIC DALI CC DRIVER

- plastic housing
- suitable for indoor use
- flicker free
- short-circuit proof and overload protection
- dimmable via DALI single dimmer



862057	<input checked="" type="checkbox"/>	350mA	0,70 - 20,00W	2-58V	30A/300µs	122 x 52 x 30 mm	44,95 €
---------------	-------------------------------------	-------	---------------	-------	-----------	------------------	----------------



DEKO-LIGHT MULTI-CURRENT DALI 2.0 POWER SUPPLIES IE-12D | IE-25D | IE-45D | IE-45HD | IE-75D

A must for every electrician: the new MULT-CC DALI 2.0 power supplies from DEKO-LIGHT are a real all-purpose weapon for universal use.

They can be controlled via DALI1 or DALI2 [fully upward and downward compatible] or via Intelli-Push. In this case, the multi-current-power supplies do not require any additional control components and are controlled by means of cost-effective 230V standard push-buttons. With the new Intelli-Push function, they also have a pioneering synchronisation option if one of the connected power supplies no longer runs synchronously with the others.

In addition, the MULTI-power supplies can also be operated undimmed without control as a reliable and universal power supplier. With a total of five models, the new DALI series covers a CC current range from 180mA to 1600mA and power ratings from 4 to 75 watts.

- plastic housing
- compact housing design
- suitable for indoor use
- flicker free
- short-circuit proof and overload protection
- overheat control
- current range adjustable via DIP switch
- DALI 2.0 BUS capable according to IEC 62386 protocol
- fully downward compatible with DALI 1.0
- Dimming range: 1-100
- dimmable via DALI or touch dimmer function [push]
- new Intelli-Push function [key combination synchronises all connected power supplies]
- can also be operated without control as universal power supply unit universal power supply [no dimming function]
- 3.2-75 watts and 37 CC variants in only 3 different housing sizes



design example 114 x 52 x 24 mm



design example 139 x 75 x 30 mm



design example 159 x 79 x 30 mm

862190	180mA	3,20 - 9,80W	18 - 54V	30A/300µs	114 x 52 x 24 mm	59,95 €	new
	230mA	4,00 - 12,00W	18 - 52V				
	260mA	4,00 - 12,00W	15 - 46V				
	300mA	4,50 - 12,00W	15 - 42V				
	350mA	4,20 - 12,00W	15 - 34V				
	400mA	6,00 - 12,00W	15 - 30V				
	450mA	5,40 - 12,00W	15 - 27V				
	500mA	7,50 - 12,00W	15 - 24V				
862191	260mA	5,00 - 15,50W	20 - 60V	30A/300µs	114 x 52 x 24 mm	64,95 €	new
	350mA	7,00 - 20,00W	20 - 60V				
	400mA	8,00 - 24,00W	20 - 60V				
	450mA	9,00 - 25,00W	20 - 55V				
	500mA	10,00 - 25,00W	20 - 50V				
	550mA	11,00 - 25,00W	20 - 45V				
	600mA	12,00 - 25,00W	20 - 42V				
	700mA	14,00 - 25,00W	20 - 36V				
862192	350mA	8,75 - 24,50W	25 - 70V	55A/100µs	139 x 75 x 30 mm	69,95 €	new
	500mA	12,50 - 35,00W	25 - 70V				
	600mA	15,00 - 42,00W	25 - 70V				
	700mA	17,50 - 45,00W	25 - 64V				
	800mA	20,00 - 45,00W	25 - 56V				
	900mA	22,50 - 45,00W	25 - 50V				
	1050mA	25,00 - 45,00W	21 - 43V				
862193	1050mA	14,70 - 45,00W	14 - 43V	55A/100µs	139 x 75 x 30 mm	69,95 €	new
	1150mA	16,10 - 45,00W	14 - 39V				
	1200mA	16,80 - 45,00W	14 - 38V				
	1300mA	18,20 - 45,00W	14 - 35V				
	1400mA	19,60 - 45,00W	14 - 32V				
	1500mA	21,00 - 45,00W	14 - 30V				
	1600mA	22,40 - 45,00W	14 - 28V				
	862194	1050mA	26,30 - 74,50W	25 - 71V	55A/300µs		
1150mA		28,80 - 74,80W	25 - 65V				
1200mA		30,00 - 74,40W	25 - 62V				
1300mA		32,50 - 75,50W	25 - 58V				
1400mA		35,00 - 74,20W	25 - 53V				
1500mA		37,50 - 75,00W	25 - 50V				
1600mA		40,00 - 75,20W	25 - 47V				





MEANWELL DALI-POWER SUPPLIES LCM-DA SERIE 25DA | 40DA | 60DA

- current range via DIP switch adjustable
- Dali Bus ready according to IEC 62386
- dimmable via DALI or touch dimmer funktion [Push]
- master/slave operation of several power supplies via sync cable [accessories]
- suitable for indoor use

862012	<input type="checkbox"/>	350mA	2,10 - 18,90W	6 - 54V	20A/260µs	105 x 68 x 23 mm	74,95 €
		500mA	3,00 - 25,20W	6 - 50V			
		600mA	3,60 - 25,20W	6 - 42V			
		700mA	4,20 - 25,20W	6 - 36V			
		900mA	5,40 - 25,20W	6 - 28V			
		1050mA	6,30 - 25,20W	6 - 24V			
862013	<input type="checkbox"/>	350mA	0,70 - 35,00W	2 - 100V	20A/260µs	124 x 82 x 23 mm	84,95 €
		500mA	1,00 - 40,00W	2 - 80V			
		600mA	1,20 - 40,00W	2 - 67V			
		700mA	1,40 - 40,00W	2 - 57V			
		900mA	1,80 - 40,50W	2 - 45V			
		1050mA	2,10 - 42,00W	2 - 40V			
862014	<input type="checkbox"/>	500mA	1,00 - 45,00W	2 - 90V	20A/260µs	124 x 82 x 23 mm	94,95 €
		600mA	1,20 - 54,00W	2 - 90V			
		700mA	1,40 - 60,30W	2 - 86V			
		900mA	1,80 - 60,30W	2 - 67V			
		1050mA	2,10 - 59,90W	2 - 57V			
		1400mA	2,80 - 59,00W	2 - 42V			



accessories

930412 SYNC-Kabel zur Synchronisation von max. 10 Netzgeräten bei Push-Funktion, Länge 300 cm **8,95 €**



design example

MEANWELL KNX-POWER SUPPLIES LCM-KN SERIES 25KN | 40KN | 60KN

- current range via DIP switch adjustable
- KNX/EIB BUS ready
- suitable for indoor use
- flicker free

862174	<input type="checkbox"/>	350 mA	2,10 - 18,90W	6 - 54V	20A/260µs	105 x 68 x 23 mm	124,95 €
		500 mA	3,00 - 25,20W	6 - 50V			
		600 mA	3,60 - 25,20W	6 - 42V			
		700 mA	4,20 - 25,20W	6 - 36V			
		900 mA	5,40 - 25,20W	6 - 28V			
		1050 mA	6,30 - 25,20W	6 - 24V			
862175	<input type="checkbox"/>	350 mA	0,70 - 35,00W	2 - 100V	20A/260µs	124 x 82 x 23 mm	134,95 €
		500 mA	1,00 - 40,00W	2 - 80V			
		600 mA	1,20 - 40,00W	2 - 67V			
		700 mA	1,40 - 40,00W	2 - 57V			
		900 mA	1,80 - 40,50W	2 - 45V			
		1050 mA	2,10 - 42,00W	2 - 40V			
862176	<input type="checkbox"/>	500 mA	1,00 - 45,00W	2 - 90V	20A/260µs	124 x 82 x 23 mm	144,95 €
		600 mA	1,20 - 54,00W	2 - 90V			
		700 mA	1,40 - 60,30W	2 - 86V			
		900 mA	1,80 - 60,30W	2 - 67V			
		1050 mA	2,10 - 59,90W	2 - 57V			
		1400 mA	2,80 - 59,00W	2 - 42V			



TCI POWER SUPPLY JOLLY MD PUSH

- dimmable via leading edge or touch dimmer funktion [Push]
- constant current [CC] or constant voltage [CV]
- adjustable via DIP switch
- master/slave operation of several power supplies via sync cable [accessories]
- suitable for indoor use



561201	<input type="checkbox"/>			165 x 48 x 35 mm	89,95 €
		constant power	350mA	0,70 - 16,50W	2 - 47V
			500mA	1,00 - 23,50W	2 - 47V
			550mA	1,10 - 25,90W	2 - 47V
			700mA	1,40 - 32,00W	2 - 46V
			750mA	1,50 - 32,00W	2 - 43V
		constant voltage	12V	10W	
			24V	20W	
			28V	22W	



accessories

561202	SYNC cable for synchronization of max. 10 power supplies with push function, length 150 cm	9,95 €
---------------	--	---------------

electr. data		dimmable via				usage / design			electrical limit values		power supply	
current	power	electronic power supply	conventional transformer	leading edge	leading / trailing edge	indoor	outdoor	design	capacitive load	max. quantity per automatic circuit breaker	item number	page
		x			x	x		basic				
12V	0,0-70,0 W	x			x	x		basic	97.79nF	B10A=8, B16A=14, C10A=18, C16A=29	180515	928
12V	0,0-105,0 W	x			x	x		basic	139.58nF	B10A=5, B16A=9, C10A=12, C16A=19	180529	928
12V	20,0-70,0 W	x			x	x		basic		B10A=35, B16A=56, C10A=35, C16A=56	862187	928
12V	34,0-105,0 W	x			x	x		basic		B10A=23, B16A=38, C10A=23, C16A=38	862188	928
12V	50,0-150,0 W	x			x	x		basic		B10A=16, B16A=26, C10A=16, C16A=26	862189	928
12V	11,5-20,0 W		x	x		x		*			000097	929
12V	34,5-60,0 W		x	x		x		*			000099	929
12V	60,5-105,0 W		x	x		x		*			000107	929
12V	86,5-150,0 W		x	x		x		*			000103	929
12V	115,0-200,0 W		x	x		x		*			000104	929
12V	172,5-300,0 W		x	x		x		*			000106	929
12V	287,5-500,0 W		x	x		x		*			000109	929
12V	43,5-75,0 W		x	x		x	x	*			000140	929
12V	86,5-150,0 W		x	x		x	x	*			000141	929
12V	172,5-300,0 W		x	x		x	x	*			000142	929

power supplies design



mini



round / octo



flat



basic



long-flat



IP

* special design

DEKO-LIGHT TRANSFORMATOR ULTRA HALOGEN

- electronic transformer [12V]
- lamp protection voltage
- plastic housing
- suitable for indoor use
- flicker free
- short-circuit proof and overload protection
- dimmable with compatible [C-compatible] trailing or leading edge phase dimmers
- **180515**: 0-70W halogen bulbs or 0-50W / max. 6 LED-light sources
- **180529**: 0-105W halogen bulbs or 0-50W / max. 6 LED-light sources



180515	■	12V	0 - 70W	0-5830 mA	20A/300µs	115 x 45 x 28 mm	17,95 €
180529	■	12V	0 - 105W	0-8750mA	30A/300µs	115 x 45 x 28 mm	22,95 €



OSRAM HALOTRONIC MOUSE TRANSFORMERS

The Osram Halotronic Mouse Transformer is ideal for confined spaces. The Halotronic Mouse series is dimmable via leading or trailing edge dimmers. With the 150VA version, you have the option of primarily looping on using two pairs of terminals.

- electronic transformer [12V]
- lamp protection voltage
- plastic housing
- suitable for indoor use
- short-circuit proof and overload protection
- dimmable with compatible [C-compatible] trailing or leading edge phase dimmers



862187	□	12V	20 - 70W	1785-6250 mA	5A/300µs	108 x 52 x 33 mm	32,95 €	new
862188	□	12V	34 - 105W	3100-9300 mA	7,5A/300µs	108 x 52 x 33 mm	36,95 €	new
862189	□	12V	50 - 150W	4390-13160 mA	11A/300µs	153 x 54 x 36 mm	56,95 €	new



ABN TRANSFORMATOREN 12 VOLT / AC

- conventional transformer
- lamp protection voltage
- dimmable via leading edge
- suitable for indoor use



design example

000097	<input type="checkbox"/>	20VA	11,50 - 20,00 W	82 x 56 x 50 mm	29,95 €
000099	<input type="checkbox"/>	60VA	34,50 - 60,00 W	100 x 70 x 61 mm	42,95 €
000107	<input type="checkbox"/>	105VA	60,50 - 105,00 W	107 x 78 x 66 mm	62,95 €
000103	<input type="checkbox"/>	150VA	86,50 - 150,00 W	130 x 88 x 78 mm	72,95 €
000104	<input type="checkbox"/>	200VA	115,00 - 200,00 W	130 x 88 x 88 mm	82,95 €
000106	<input type="checkbox"/>	300VA	172,50 - 300,00 W	130 x 88 x 103 mm	109,95 €
000109	<input type="checkbox"/>	500VA	287,50 - 500,00 W	177 x 107 x 130 mm	189,95 €



optionales accessories transformer housing Pyra

000110		for 105 W	14,95 €
000111		for 150-300 W	16,95 €



ABN TRANSFORMERS 12 VOLT / AC

- conventional transformer
- lamp protection voltage
- 1,9 m connection cable [primary]
- 0,5 m connection cable [secondary]
- dimmable via leading edge
- suitable for indoor and outdoor use



design example

000140	<input checked="" type="checkbox"/>	75VA	43,50 - 75,00 W	108 x 81 x 66 mm	76,95 €
000141	<input checked="" type="checkbox"/>	150VA	86,50 - 150,00 W	130 x 93 x 78 mm	89,95 €
000142	<input checked="" type="checkbox"/>	300VA	172,50 - 300,00 W	130 x 93 x 102 mm	124,95 €



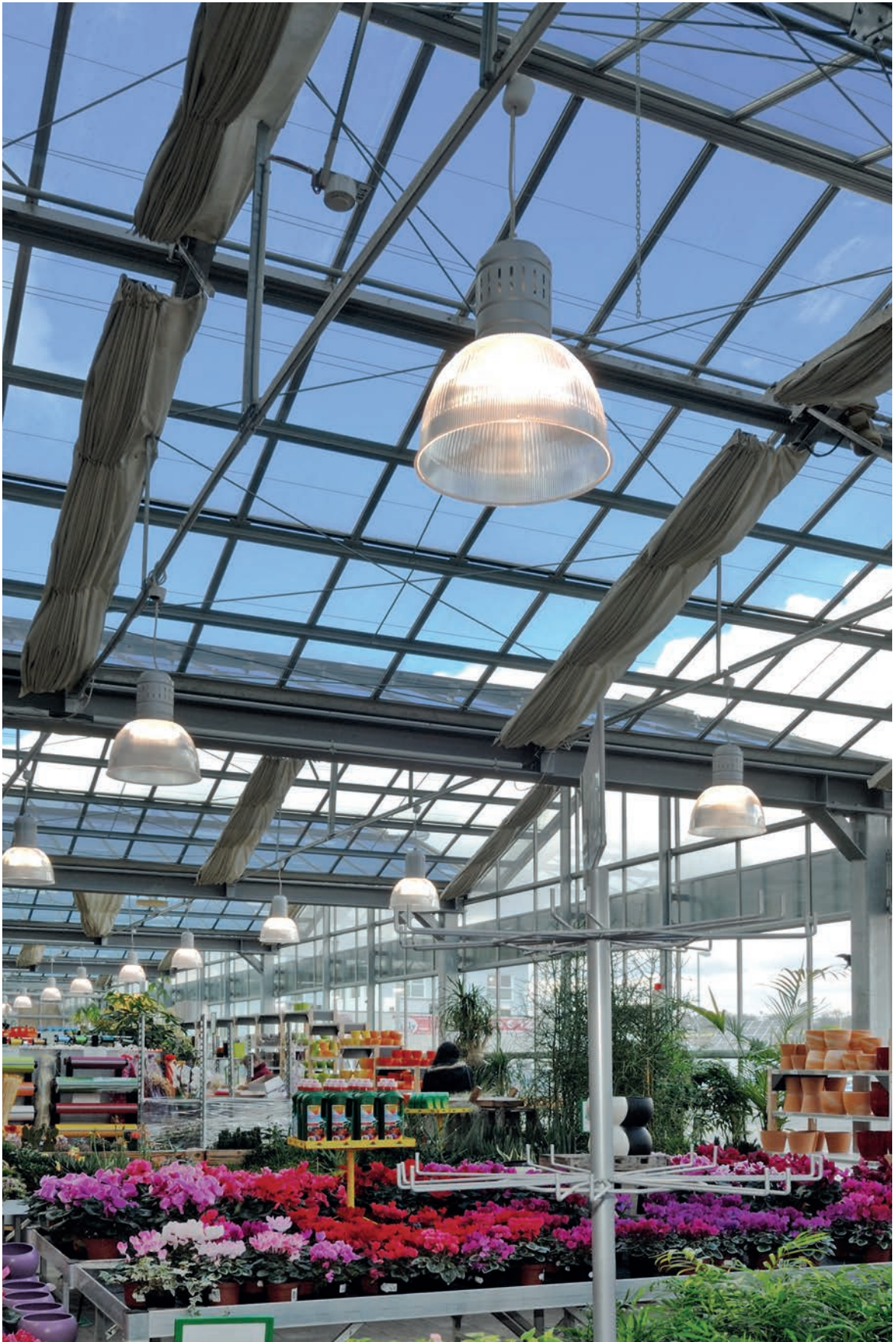

OSRAM ELECTRONICAL BALLAST PTI70

- für 70W metal halide lamps
- dimensions L x W x H: 171 x 83 x 32 mm
- automatic safety shutdown in case of lamp damage
- incl. pull relief
- suitable for indoor use

150921



69,95 €



HEP ELECTRONICAL BALLAST SH70GB

- for 70W metal halide lamps
- dimensions L x W x H: 110 x 75 x 32 mm
- suitable for indoor use

800030



69,95 €





■ Quasar
page 939

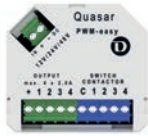

□ Quasar
page 941



■ Quasar
page 943



□ ■ Casambi Bluetooth
page 944



□ Casambi Bluetooth
page 944



□ Casambi Bluetooth
page 945



□ ■ Casambi Bluetooth
page 945



■ □ RF controller | 1 - 4 channel
from page 946



□ □ RF touchpanel | 1 - 4 channel
from page 948



■ DMX wall controller
page 952



■ DMX wall controller
page 952



■ DMX wall controller
page 953



■ DMX wall controller
page 954



■ DMX wall controller
page 954



■ DMX wall controller
page 955



■ DMX controller
page 956



■ DMX controller
page 957



■ DMX dimmer
page 958



■ DMX dimmer
page 958



■ DMX dimmer
page 959



■ DMX dimmer
page 959



DMX dimmer
page 959



DMX dimmer
page 960

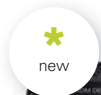

new



DMX dimmer
page 960



DMX dimmer
page 961



DMX dimmer
page 961



DALI PWM dimmer
page 962



DALI PWM dimmer
page 962



DALI PWM dimmer
page 963

controller

DEKO-LIGHT QUASAR – THE SMART UNIVERSAL CONTROL FOR LIGHT & CO.

Our new and universal Bluetooth control »Quasar« enables you to use and control all common lighting components such as lights, lamps, LED strips etc. as well as electrical devices with 230V mains voltage.

You decide whether you want to do this conveniently via smartphone, tablet and / or light switches. Through the integrated inputs for conventional light switches, »Quasar« can be perfectly integrated into an existing electrical installation and thus also into the existing switch range. It does not matter whether you want to plan, modernize or expand a new building.

Thanks to the pre-configured Quasar modules [see Fig.] installation and commissioning are child's play. Immediately after connection, all necessary function tests of the connected components can be carried out. This reduces installation costs and increases efficiency.

With the app, we also made sure to create a user-friendly and intuitive user interface. It controls both all standard functions that are also available when operated with switches, as well as the many additional and automatic functions that make your lighting control system »smart« and comfortable. So there are almost no limits to your imagination.

Speaking of limits – thanks to the latest Multi-Protocol-Mesh-Technology and the interaction of the individual modules, these automatically connect to form a network with which even complex lighting control networks with extensive requirement profiles can be set up. Every module is part of the network and thus also extends the range of the radio network, but can also be completely independent.

Quasar is simple, flexible, comfortable, safe and incredibly smart.

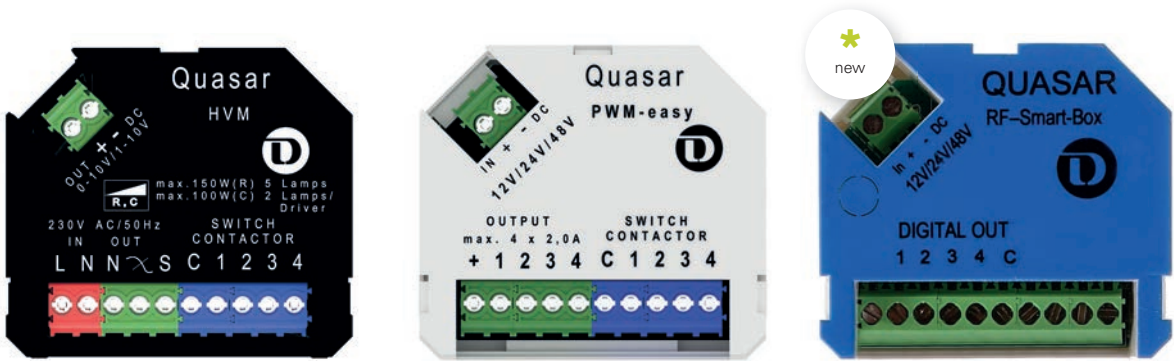

original size

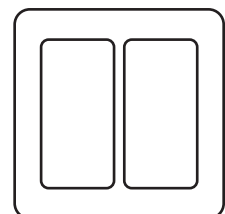
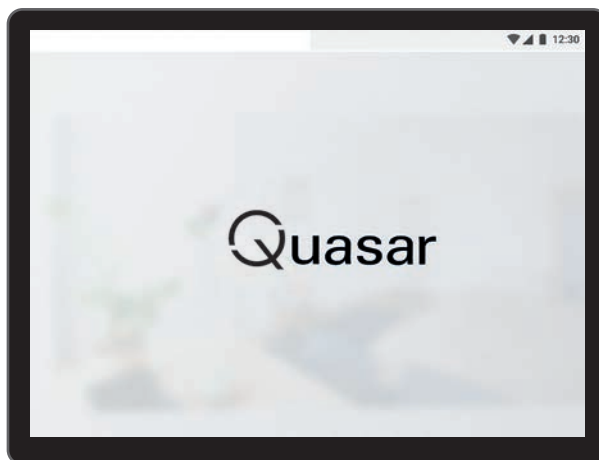

WHAT CAN QUASAR CONTROL?

By using the two modules [see pages 802-805] there are countless connection options for almost all types of common lights, illuminants and components. From conventional light bulbs, LED / retro-Fit lamps, LED lights with permanently installed electronic ballasts, power supplies with 0-10V / 1-10V control input, 1-4 channel LED strips and all compatible devices and consumers that can be switched or dimmed using 230V mains voltage.

OPTIONAL OPERATING MODES

Depending on the Quasar module used and the connected one consumers can select the required operating mode quickly and easily. Switching, dimming, different modes for 1-4 channel LED strips and a special sensor mode enable previously unimagined control options and functions.

RANGE AND SECURITY

By using the latest microprocessors and encrypted Multi-Protocol-Mesh-Technology, the Quasar modules offer maximum security and maximum range. Each module also serves as a repeater within the network and increases the range accordingly. Any Quasar module can be used as a repeater to connect controllers that are too far away. Both the Quasar control modules and the Quasar app can be kept up to date by software updates if required. So you always enjoy the full and updated range of functions.

EASY AND QUICK INSTALLATION

Due to the compact design and depending on the application, the modules can often be installed almost »invisibly« directly in the junction box, in the lamp canopy or with the power supply. The modules are already pre-configured for the most common applications, which means that the most important functions can be operated and tested using the switch inputs after installation, even without using the Quasar app. A multi-coloured signal LED inside the module provides information about the operating status and any faults at any time.

CUSTOMIZE SWITCHING SIGNALS

Many switching parameters such as the duty cycle, dimming behaviour, soft start, switch-on and switch-off delays as well as the minimum and maximum brightness can be adapted to the respectively connected lights or consumers.

FLEXIBLE USE AND OPERATION

The modules can be used as individual, autonomously operating controllers or in combination with many others controllers they work in networked operation. No central control unit is required. Every controller can be operated by up to 4 buttons, by app for smartphone / tablet or in combination with app and button respectively. This ensures that you can switch the lighting quickly and easily always on entering or leaving a room.

EASY APP START-UP AND CONTROL

If you want to operate the Quasar modules with a smartphone or tablet [Android / iOS, compatible from BT4.2], download the Quasar app - available free of charge in the App / Play-Store and install the app. Then everything is lightning fast: create a free user account via the intuitive menu, log in, set up the rooms in which Quasar modules are installed, scan the assembled and operational controllers and configure them according to your wishes. Your smart Quasar network is ready.



QUASAR – THREE MODULES, INFINITE POSSIBILITIES

With the help of the Quasar house on the right, we would like to better illustrate the various possibilities that may arise from the use of the modules. If you take a closer look, you will surely recognize application scenarios from your environment very quickly. Let your [control] wishes and thoughts run free! You will be sure to recognize many other exciting applications in a very short time that can make your house installation safer, complement it, upgrade it or simply make it more convenient.

Quasar is simple, flexible, comfortable, safe and incredibly smart.

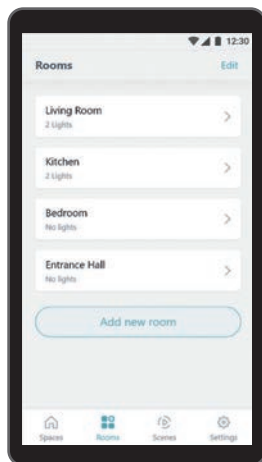
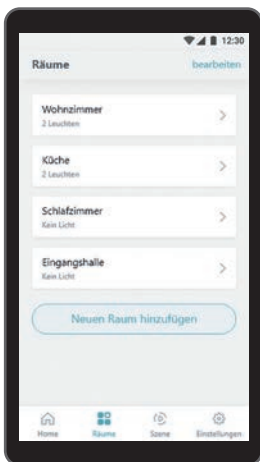
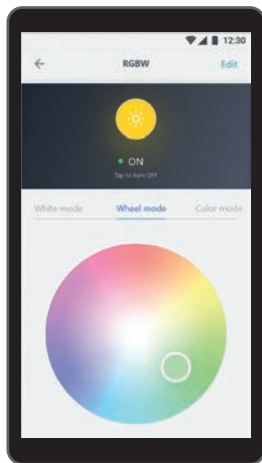
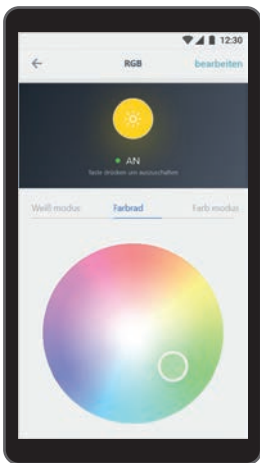

EXTERIOR LIGHTING

By using a Quasar module, for example, a time-controlled night light with a defined minimum brightness can be switched on or by linking to a motion detectors. This creates security and also protects your wallet.



GARDEN AND PATHS

By illuminating paths, natural stone walls, sculptures or plants you create a very special and magical ambience. You can easily control everything with the Quasar modules. Here you have the choice whether automatic or time-controlled programs, linked motion sensors or whether you want to control the lighting manually.

Our tip: With a few additional components, you can switch many 230V consumers with the Quasar HVM controller. e. g. automate a fountain or circulation pump of a swimming pond from a distance or switch manually.



STAIRS AND HALLWAYS

VNetwork different luminaires that previously had to be switched on and off individually due to the lack of cables, to one area. In addition, the light control can be automated by an automatic timer and, incidentally, a lot of electricity can be saved.

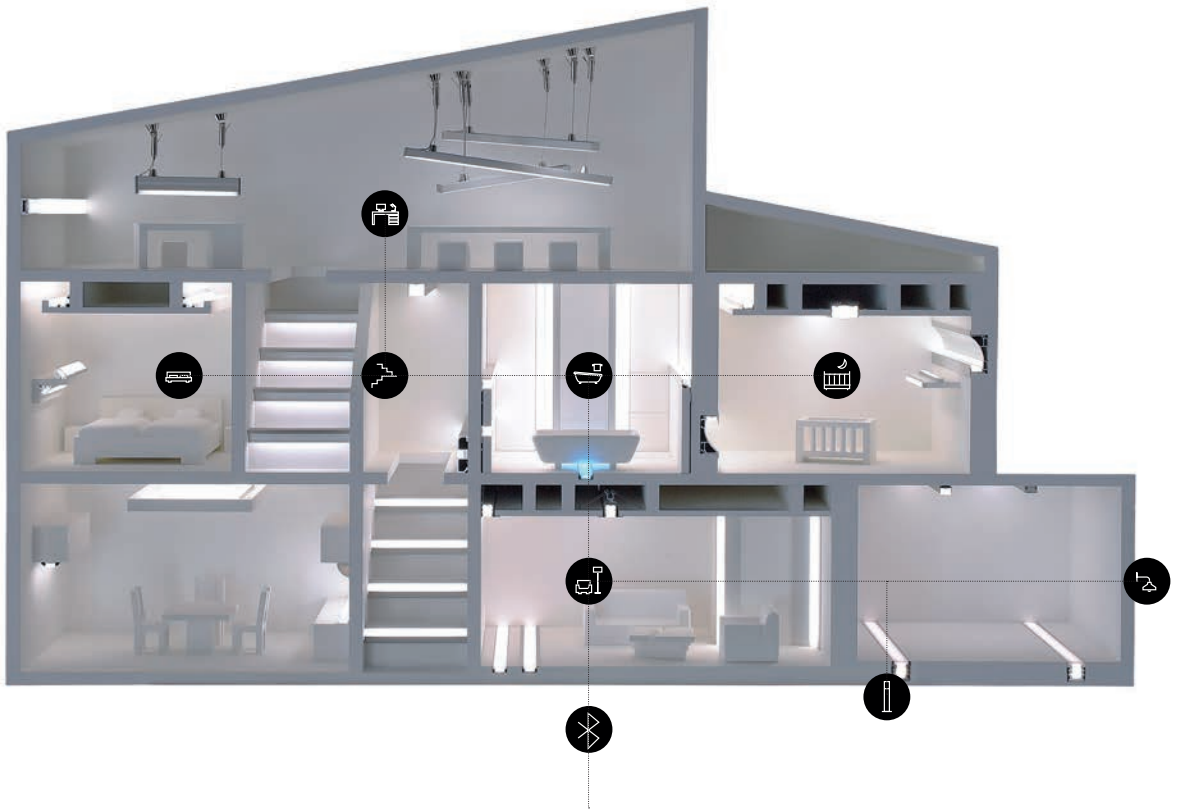

LIVING AREAS

Individual lights or the complete lighting equipped with Quasar can be controlled. It does not matter whether luminaires with classic lamps, LEDs with ballasts or LED strips are installed. With Quasar everything can be controlled at a glance and comfortably from a central location using a smartphone or a conventional button.



CHILDREN'S ROOM

Wake up your kids with slowly brightening lights [wake-up sunrise] or let them fall asleep with a sunset simulation. Of course, all other common lights can also be controlled. If desired, all functions can also be started via smartphone or tablet.



OFFICE

Use the new possibilities of an HCL control [Human Centric Lighting], in which the light colour and intensity are automatically adjusted to the time of day and the location. The positive effect of a light adapted to the daily rhythm increases well-being considerably.



BEDROOMS

In addition to bedroom lighting, control all of the quasar modules throughout the house comfortably from your bed. So you never have to get up to switch off forgotten lights.

PANIC BUTTON

Create additional security e.g. by linking a button of a Quasar module with other components in the bedroom. In this way, you can easily and inexpensively install one or more »panic buttons« in your installation. As soon as you press this button, the light goes on on all linked modules and thus possibly also outdoors, and any intruders are deterred.



BATHROOM / WELLNESS

Transform your bathroom into a wellness area and control, for example, coloured LED strips with Quasar. Dim lighting and automatic colour changes complete the installation and make the controls child's play.

Our tip: With a few additional components, you can control many 230V consumers with the Quasar HVM controller for example switching on an additional heater from a distance.

DEKO-LIGHT QUASAR HVM 230V DIMMING AND SWITCHING WITH A SMARTPHONE AND / OR BUTTON

With this small module, which is directly in a junction box or can be installed in a lamp canopy suitable lights, power supplies or other compatible 230V components can be dimmed or switched directly. Via the 0-10V / 1-10V control output, power supply units with the corresponding control input can still be dimmed and switched.

With the additional sensor function of the module, all commercially available motion detectors, twilight switches etc. that are equipped with a 230V switching output can become a radio actuator. The problem solver wherever there are no corresponding cables.

Commissioning is child's play thanks to many preconfigured scenes. To be able to use them, you only need to connect potential-free buttons [1-4 depending on the function]. Since standard push buttons are used, you can integrate Quasar into any existing electrical installation and thus into the switch ranges of all manufacturers.



control output
for 0-10V / 1-10V power supplies

original size

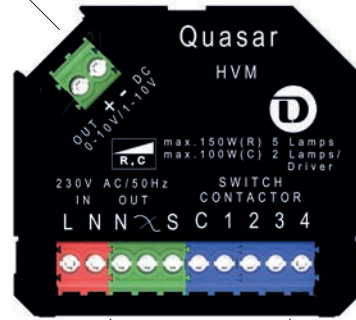

power input and output 230V

analog switches 1 - 4

DEKO-LIGHT QUASAR HVM

- plastic housing
- dimensions L x W x H: 46 x 41 x 24 mm
- stand-alone or networked operation
- quick installation through pre-installed programs and dimming functions
- controllable via up to 4 potential-free buttons and / or smartphone app
- adjustable and freely configurable: dimming level, minimum and maximum brightness, programs, speed, time- / day-dependent switching cycles
- data transmission using the latest BT-Mesh technology
- power for suitable R loads [incandescent lamp, high-voltage halogen] 1 - 150W / max. 5 components
- power for suitable C-loads [high-voltage LED, electrical power supplies] 1 - 100W / max. 2 components
- control output 0-10V / 1-10V for up to 5 power supply units [switching capacity max. 100W, higher capacity by means of additional relay [not included]]
- overload, overheating, network, operation
- connection via screw terminals

843007 ■ black

119,95 €

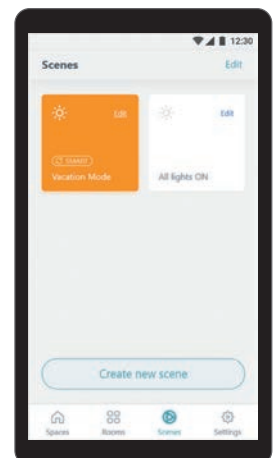
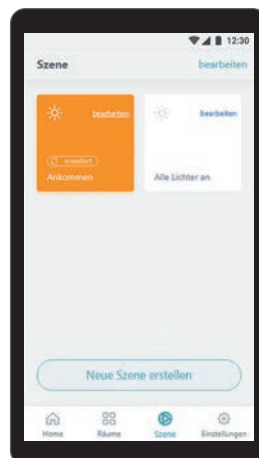
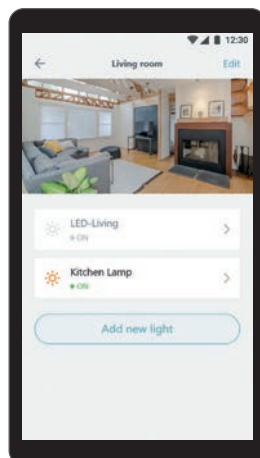
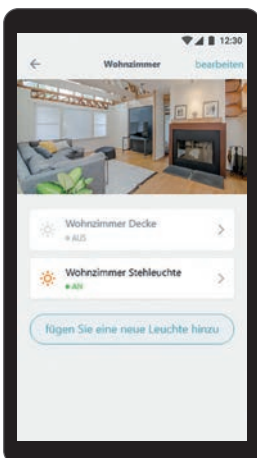

DEKO-LIGHT QUASAR PWM-EASY 1-4 CHANNEL STRIPES AND LED CONTROLS WITH SMARTPHONE AND / OR BUTTON

This small module can be installed directly on the corresponding power supply or in a nearby junction box and controls all common 1-4 channel LED stripes and lights [single, WW / CW, RGB, RGBW] which are operated with a voltage of 12V, 24V or 48V DC and controlled by PWM control.

As with the HVM module, commissioning is child's play thanks to the many pre-configured scenes. To be able to use them, you only need to connect potential-free buttons 1-4 depending on the function]. Since standard push buttons are used, you can integrate Quasar into any existing electrical installation and thus into the switch ranges of all manufacturers.

With this module, too, you have the option to control all basic functions as well as countless additional functions with the Quasar app for compatible Android and Apple smartphones [BT from 4.2]. The configuration and operation is simple and intuitive.



With the kind support of Göbel's Schlosshotel / 36289 Friedewald

DC power supply
12/24/48 volts

original size

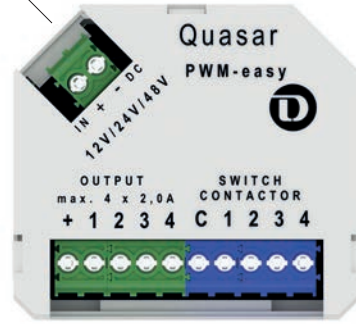

analog switches 1 - 4

switches up to 4 LED sources
with up to max. 2 A / channel
or 8 A when bridged

DEKO-LIGHT QUASAR PWM-EASY

- plastic housing
- dimensions L x W x H: 46 x 41 x 24 mm
- stand-alone or networked operation
- quick installation through pre-installed programs and dimming functions
- for the control of 1-4 channel LED stripes / lights [single, WW/CW, RGB, RGBW]
- controllable via up to 4 potential-free buttons and / or smartphone app
- adjustable and freely configurable: colours, brightness, programs, speed, time- / day-dependent switching cycles [e.g. HCL]
- data transmission using the latest BT-Mesh technology
- max. power per module:
 - 12V DC = 4x 24W [each channel] or 1x 90W [bridged mode]
 - 24V DC = 4x 48W [each channel] or 1x 190W [bridged mode]
 - 48V DC = 4x 96W [each channel] or 1x 380W [bridged mode]
- load quantity per module: max. 5 components of the same type
- overload, overheating, network, operation display
- connection via screw terminals [4x V-, V+]

843053 white

119,95 €

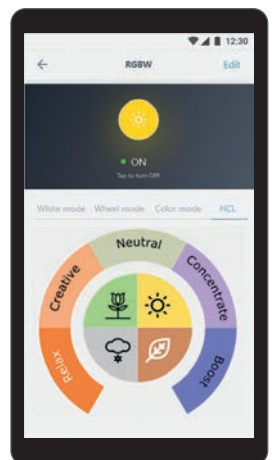
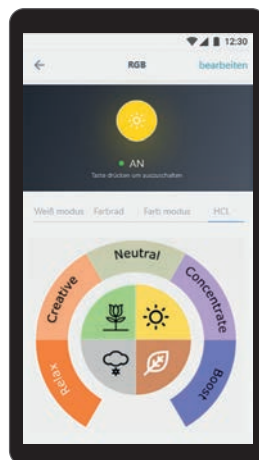
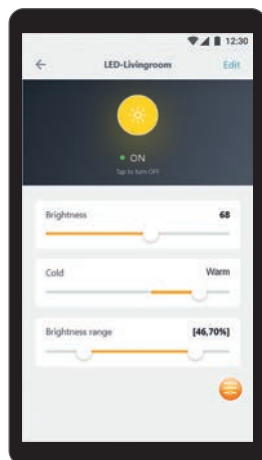
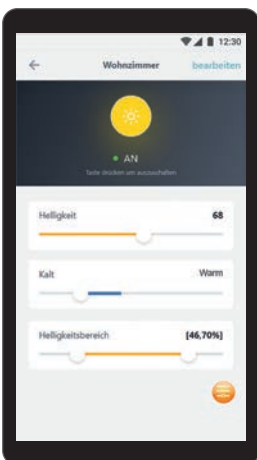

DEKO-LIGHT QUASAR RF-SMART-BOX NOT ONLY TAKES EXISTING INSTALLATIONS TO THE NEXT LEVEL

The small blue RF Smart Box is a real all-rounder, because on the one hand it makes it possible to operate an existing LED stripe installation, which was previously controlled with the popular DEKO-LIGHT RF system via remote control, can now be operated with a smartphone and thus benefit from the possibilities and advantages of a modern control system.

The conversion is very simple: connect the RF Smart Box to the existing LV power supply, plug in the RF controller and you're done! Afterwards, the app, which is available free of charge, can be put into operation and adapted accordingly.

Furthermore, there are no more performance limits to your planning with Quasar. Using the RF-Link control signal, you can control one or more RF controllers connected via RJ45 cable simultaneously. In this way, you can also realise high performance requirements of more complex or extensive installations.

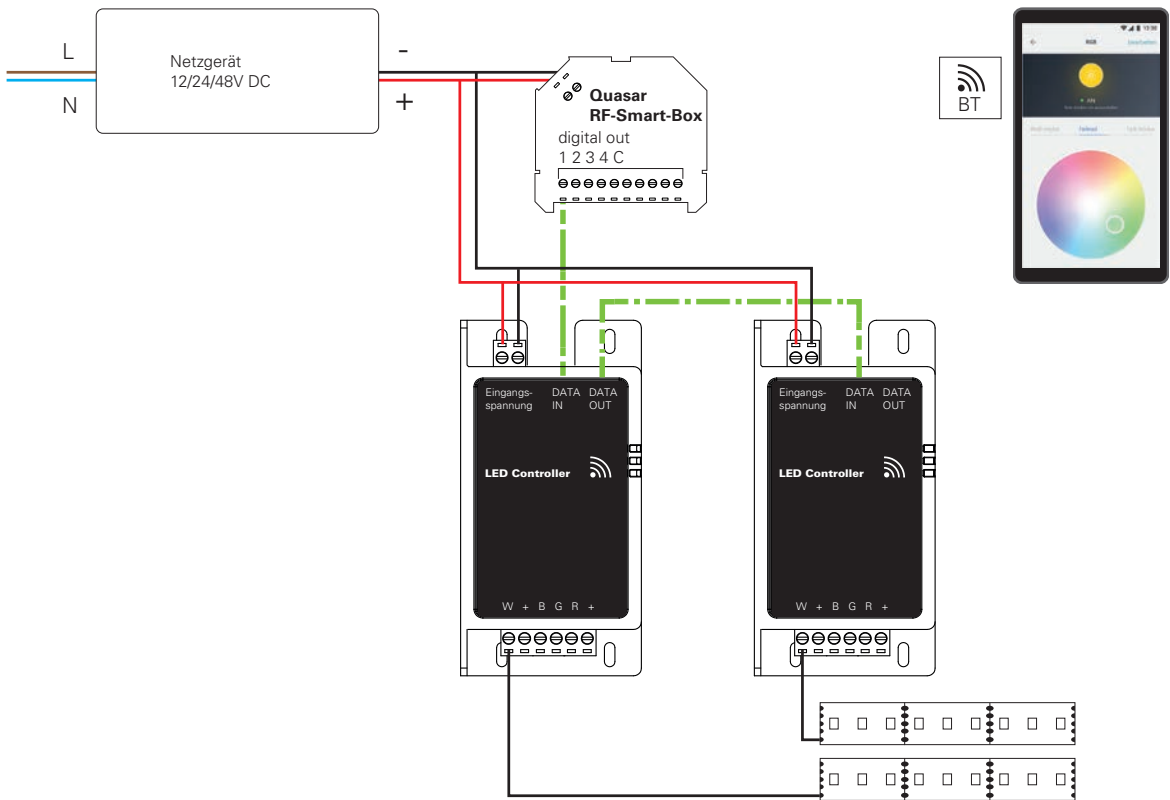

DC power supply
12 / 24 / 48 Volt

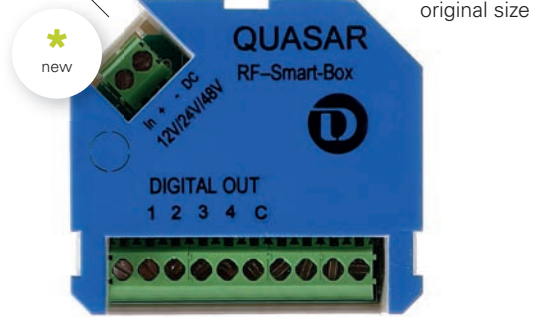

RF-Link [digitales Ausgangssignal]
zur Ansteuerung von 1-4 channel
RF-Controllern

DEKO-LIGHT QUASAR RF-SMART-BOX

- plastic housing
- dimensions L x W x H: 46 x 41 x 24 mm
- stand-alone or networked operation
- quick installation through pre-installed programs and dimming functions
- digital output signal [RF-Link] for control of DEKO-LIGHT RF controllers [single, WW/CW, RGB, RGBW see p. 946]
- adjustable and freely configurable: colours, brightness, programs, speed
- data transmission using the latest BTMesh technology
- connection via screw terminals
- CAT5 adapter incl. cable for connection to RF controller included in delivery

module incl. adapter and CAT5 cable
for connection to RF controller

843061 ■ blue

149,95 €

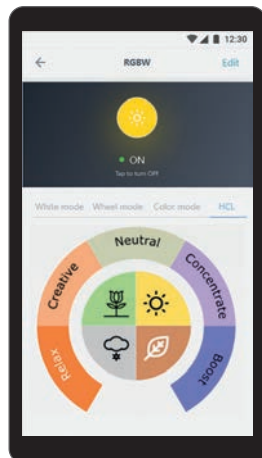
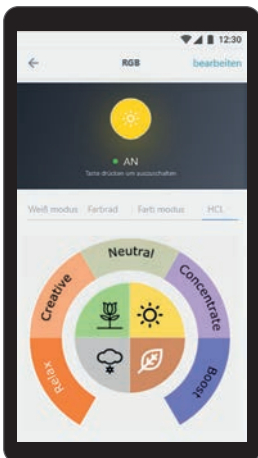

SMART HOME CAN BE SO SIMPLE

Install the Casambi module in the distribution box, suspended ceiling or similar – install the app from the Playstore/iTunes, connect the module to your mobile phone and the app, set it up and off you go!

CASAMBI BLUETOOTH CBU-TED | 230V SWITCHING/DIMMING

With this module 230V components can be directly dimmed or switched [configuration via mobile app].

- suitable for R-loads [light bulb, high-voltage halogen]
- suitable for C-loads [dimmable high-voltage LED, electrical power supplies]
- power in switching operation: light bulb, high-voltage halogen, high-voltage LED, electrical ballasts: max. 150W
- power in dimming mode: dimmable high-voltage LED, electrical ballasts: max. 50W / max. 2 components
- dimensions L x W x H: 40,4 x 36,3 x 14 mm



843008 white

131,95 €



CASAMBI BLUETOOTH CBU-ASD | DALI/0-10V | 1-10V

The module generates either a DALI, 0-10V or 1-10V control signal with which 1 ballast/power supply or similar can be operated [configuration via mobile app].

- dimensions L x W x H: 56,5 x 35,8 x 22,3 mm

843011 white

131,95 €



CASAMBI BLUETOOTH CBU-PWM4 | LED 1-4 CHANNEL DIMMER

With this module you can control 12V/24V LED stripes, lamps etc. with 1-4 channels [WW, CW, WW-CW, RGB, RGBW], which can be controlled by PWM [configuration via mobile app].

- dimensions L x W x H: 72,6 x 30 x 18 mm
- power 144W at 24V, 72W at 12V

843037 white **144,95 €**

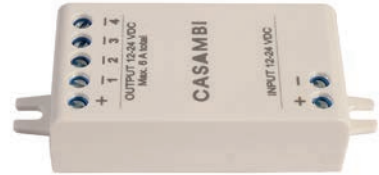

CASAMBI BLUETOOTH WALL CONTROLLER XPRESS

- Bluetooth-wall controller compatible with Casambi-System
- mounting with screws or adhesive pad
- independent mounting, as battery operated [3V button cell] and no cabling necessary
- setup and programming via Casambi-App
- plastic
- L x W x H: 90 x 90 x 12 mm

843050 white **344,95 €**

843049 black **344,95 €**



RF CONTROLLER

The respective receiving systems are controlled within a range of 20 m through remote control. The system can be expanded in a simple manner by connecting one single remote control to several controller boxes. Note: A 100% synchronous controlling [program sequence, colour chan-

ge] of several control boxes with one single remote control can be implemented only with an available network cable connection [Master-Slave function]. The memory effect saves the most recent setting after a power failure.



DEKO-LIGHT CONTROLLER SET RF SINGLE

- for controlling 1-channel LED stripes
- set consists of: controller box, remote control and wall bracket
- dimmable
- 4 effect programs
- speed setting
- max. 8 remote controls / 2 touch panels per system range
- memory-function
- Master/Slave-function
- dimensions L x W x H: 110 x 52 x 20 mm
- max. 7,5A each channel
- power: 2x 90W [180W] at 12V DC,
2x 180W [360W] at 24V DC,
2x 360W [720W] at 48V DC

843056 ■ black

94,95 €

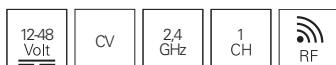

accessories for 843056

843064	controller	79,95 €
843014	remote control	29,95 €
843013	wall bracket	9,95 €
843018	touch panel	89,95 €



DEKO-LIGHT CONTROLLER SET RF WHITE

- for controlling WW/CW LED stripes
- set consists of: controller box, remote control and wall bracket
- WW or CW als Einzelfarbe dimmable
- 9 effect programs
- speed setting
- max. 8 remote controls / 2 touch panels per system range
- memory-function
- Master/Slave-function
- dimensions L x W x H: 110 x 52 x 20 mm
- max. 7,5A each channel
- power: 2x 90W [180W] at 12V DC,
2x 180W [360W] at 24V DC,
2x 360W [720W] at 48V DC

843057 ■ black

99,95 €



accessories for 843057

843065	controller	79,95 €
843015	remote control	29,95 €
843013	wall bracket	9,95 €
843019	touch panel	89,95 €

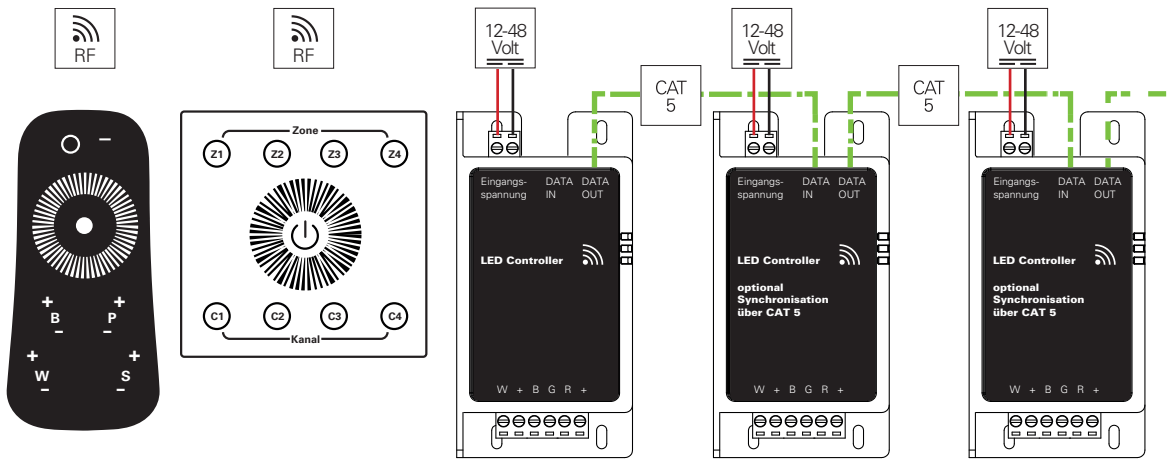

outputs for LED stripes/luminaires



DEKO-LIGHT CONTROLLER SET RF COLOR

- for controlling RGB LED stripes
- set consists of:
controller box, remote control and wall bracket
- R/G/B als Einzelfarbe dimmable
- 13 effect programs
- speed setting
- max. 8 remote controls / 2 touch panels per system range
- memory-function
- Master/Slave-function
- dimensions L x W x H: 110 x 52 x 20 mm
- max. 5,0A each channel
- power: 3x 60W [180W] at 12V DC,
3x 120W [360W] at 24V DC,
3x 240W [720W] at 48V DC

843058 ■ black

104,95 €

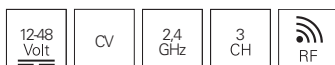

accessories for 843058

843066	controller	84,95 €
843016	remote control	29,95 €
843013	wall bracket	9,95 €
843020	touch panel	89,95 €



DEKO-LIGHT CONTROLLER SET RF COLOR & WHITE

- for controlling RGB + white LED stripes
- set consists of:
controller box, remote control and wall bracket
- R/G/B + white als Einzelfarbe dimmable
- 12 effect programs
- speed setting
- max. 8 remote controls / 2 touch panels per system range
- memory-function
- Master/Slave-function
- dimensions L x W x H: 110 x 52 x 20 mm
- max. 5,0A each channel
- power: 4x 45W [180W] at 12V DC,
4x 90W [360W] at 24V DC,
4x 180W [720W] at 48V DC

843059 ■ black

109,95 €



accessories for 843059

843067	controller	84,95 €
843017	remote control	29,95 €
843013	wall bracket	9,95 €
843021	touch panel	89,95 €

DEKO-LIGHT TOUCH PANEL RF WITH 4-ZONE-FUNCTION | 4 AREAS SEPARATELY CONTROLLED

The respective receiving systems are controlled within a range of 20 m through the touch panel. The system can be expanded in a simple manner by connecting one single touch panel to several controller boxes. Note: A 100% synchronous controlling [program sequence, colour change] of

several control boxes with one single remote control per zone can be implemented only with an available network cable connection [Master-Slave function]. The memory effect saves the most recent setting after a power failure. The unit is mounted in a 68mm single device box.



DEKO-LIGHT WALL TOUCH PANEL RF SINGLE

- control of the controller via radio, no additional control lines necessary
- for controlling 1-channel LED stripes / luminaires
- 4 zones
- independent dimming of individual zones
- all zones can be switched on/off together
- 4 effect programs
- speed setting
- memory-function
- dimensions L x W x H: 86,5 x 86,5 x 31,1 mm

843018 white

89,95 €

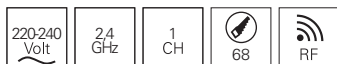

DEKO-LIGHT WALL TOUCH PANEL RF WHITE

- control of the controller via radio, no additional control lines necessary
- for controlling WW/CW LED stripes / luminaires
- 4 zones
- independent dimming of individual zones
- all zones can be switched on/off together
- 9 effect programs
- speed setting
- memory-function
- dimensions L x W x H: 86,5 x 86,5 x 31,1 mm

843019 white

89,95 €

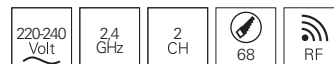

accessories for 843018

843064 controller

79,95 €

accessories for 843019

843065 controller

79,95 €

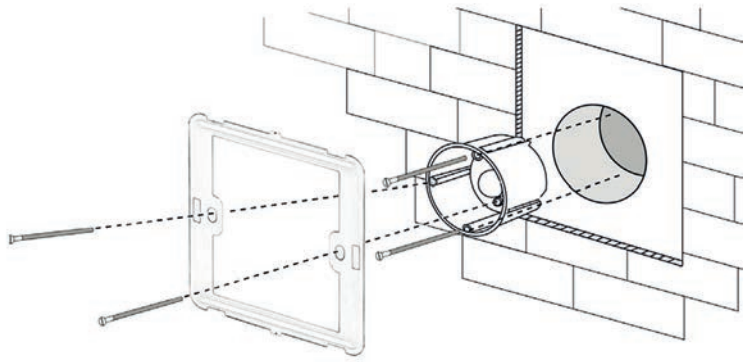

DEKO-LIGHT WALL TOUCH PANEL RF COLOR

- control of the controller via radio,
no additional control lines necessary
- for controlling RGB LED stripes / luminaires
- 4 zones
- independent dimming of individual zones
- all zones can be switched on/off together
- 13 effect programs
- speed setting
- memory-function
- dimensions L x W x H: 86,5 x 86,5 x 31,1 mm

843020 white

89,95 €

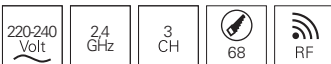

DEKO-LIGHT WALL TOUCH PANEL RF COLOR & WHITE

- control of the controller via radio,
no additional control lines necessary
- for controlling RGB + white LED stripes / luminaires
- 4 zones
- independent dimming of individual zones
- all zones can be switched on/off together
- 12 effect programs
- speed setting
- memory-function
- dimensions L x W x H: 86,5 x 86,5 x 31,1 mm

843021 white

89,95 €

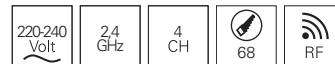

accessories for 843020

843066 controller

84,95 €

accessories for 843021

843067 controller

84,95 €

DMX controller		max. number of zones	DMX channels per zone	1-channel-Modus [single]	2-channel-Modus [CW-WW]	3-channel-Modus [RGB]	4-channel-Modus [RGBW]	5-channel-Modus [RGBW-A]	6-channel-Modus [RGB-CW-WW-A]
843005 TC-2 	wall controller for dimming of 1-DMXchannel with 4 programmable keys	1	1	yes	-	-	-	-	-
843000 Art-4 RGB/RGBW 	controller can next to 4-channel RGBW also for 3-channel RGB components used become	1	3/4	-	-	yes	yes	-	-
843003 Art-9 RGB/RGBW 	controller can next to 4-channel RGBW also for 3-channel RGB components used become	1	3/4	-	-	yes	yes	-	-
843004 Touch 16CH Pro 	the 4 zones of the controller can be any be mixed [1- / 2- / 3- / 4-channel]	4	1-4	yes [zonemix available]	yes [zonemix available]	yes [zonemix available]	yes [zonemix available]	-	-
861203 X-Fade-6 II 	simple wall controller for the simple and manual Dimming from up to 6 DMX channels	-	1-6	yes	manual regulati-on [max. 3x 2 channels]	manual regulati-on [max. 2x 3 channels]	manual regulati-on [max. 1x 4 channels]	-	-
843001 Touch 16C 	wall controller for controlling up to 16 DMX channels	4	1-4	yes [max. 16x 1 channel]	manual colour-setting [max. 8x 2 channels]	manual colour-setting [max. 4x 3 channels]	manual colour-setting [max. 4x 4 channels]	-	-
843046 LED EASY Operator 	comfotable controller with programmable keys, programs ideal for gastro-nomy, events and more compre-hensive installations	4	1-6	yes [max. 4x 1 channel]	yes [max. 4x 2 channel]	yes [max. 4x 3 channel]	yes [max. 4x 4 channel]	yes [max. 4x 5 channel]	yes [max. 4x 6 channel]
843047 LED Color Chief 	top controller with programmable keys, programs and USB backup ideal for gastro-nomy, events and more comprehensive installations	8	1-6	yes [max. 8x 1 channel]	yes [max. 8x 2 channel]	yes [max. 8x 3 channel]	yes [max. 8x 4 channel]	yes [max. 8x 5 channel]	yes [max. 8x 6 channel]

DMX dimmer		available channel mode	compatible with 1-channel-controllers	compatible with 2-channel-controllers	compatible with 3-channel-controllers	compatible with 4-channel-controllers	compatible with 5-channel-controllers	compatible with 6-channel-controllers	flicker free
843336 LED dimmer 2 	simple DMX dimmer with high PWM rate [deployment in areas, in those filmed will]	1/2	yes	yes	-	-	-	-	yes
843268 OLED dimmer 3 	just about display, internal car programs or manual control system even without a controller, simple DMX installation through CAT5 cable	1/3	yes	-	yes	-	yes [wird 2x benötigt]	yes [wird 2x benötigt]	-
843335 LED dimmer 3 	simple DMX dimmer with high PWM rate [deployment in areas, in those filmed will]	3	-	-	yes	-	yes [required two times]	yes [required two times]	yes
843269 OLED dimmer 4 	just about display, internal car programs or manual control system even without a controller, simple DMX installation through CAT5 cable	1/2/4	yes	yes	-	yes	-	-	-
843337 LED dimmer 4 	simple DMX dimmer with high PWM rate [deployment in areas, in which will be filmed]	4	-	-	yes	yes	-	-	yes
843273 dimmer R-DMX 3+1 	DMX dimmer with remote configuration possibility [R-DMX] especially for the events sector	3/4	-	-	yes	yes	-	-	-
843060 LED-dimmer DMX, R-DMX 	DMX dimmer 12-48V, addressing via DIP switches	1/3/4	yes	yes	yes	yes	yes [required two times]	yes [required two times]	yes
843054 LED-dimmer DMX for [CC] current stable luminares 	DMX dimmer 24-50V, 4x60W, programming via display	1/2/3/4	yes	yes	yes	yes	yes [required two times]	yes [required two times]	yes



DEKO-LIGHT CONTROLLER TC-2

The TC-2 controller is a touch panel, allowing the storage and retrieval of up to 4 storage locations. Scenes and atmospheres are created quickly in a user-friendly manner with the aid of the intuitive controller. It suits both hotels and auditoriums, as well as the home and living space.

- touch interface
- optional DMX512 or analogous 0-10V
- fade time setting from 0.01 to 10s
- dimming steps 0-100%
- LED Display
- 4 storage locations
- DMX out / DC in / 0-10V out: connection terminals
- dimensions L x W x H: 86 x 86 x 15,3 mm

843005 ■ black

189,95 €

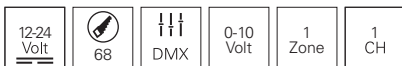

accessories

872128 power supply Mini 24V/4W

11,95 €

952 CONTROLLER | DMX wall controller



DEKO-LIGHT TOUCH 16CH PRO

The Touch 16CH Pro controller is a touch panel, allowing the storage and retrieval of up to 4 zones with 4 channels each. Scenes and atmospheres are created quickly in a user-friendly manner with the aid of the intuitive controller. It suits both hotels and auditoriums, as well as the home and living space. As a design element, the Touch 16Ch Pro is ideally implemented in the living space.

- colour mode for setting the colours in each individual zone
- program mode for the colour change and fader setting for each zone
- time mode for setting the start and end time of the programs
- 14 pre-installed or 8 auto-created programs can be assigned to one scene
- internal clock to switch the zones time-dependently with the saved programs
- DMX out / DC in: connection terminals
- dimensions L x W x H: 86 x 86 x 15,3 mm

843004 ■ black

319,95 €



accessories

872128 power supply Mini 24V/4W

11,95 €

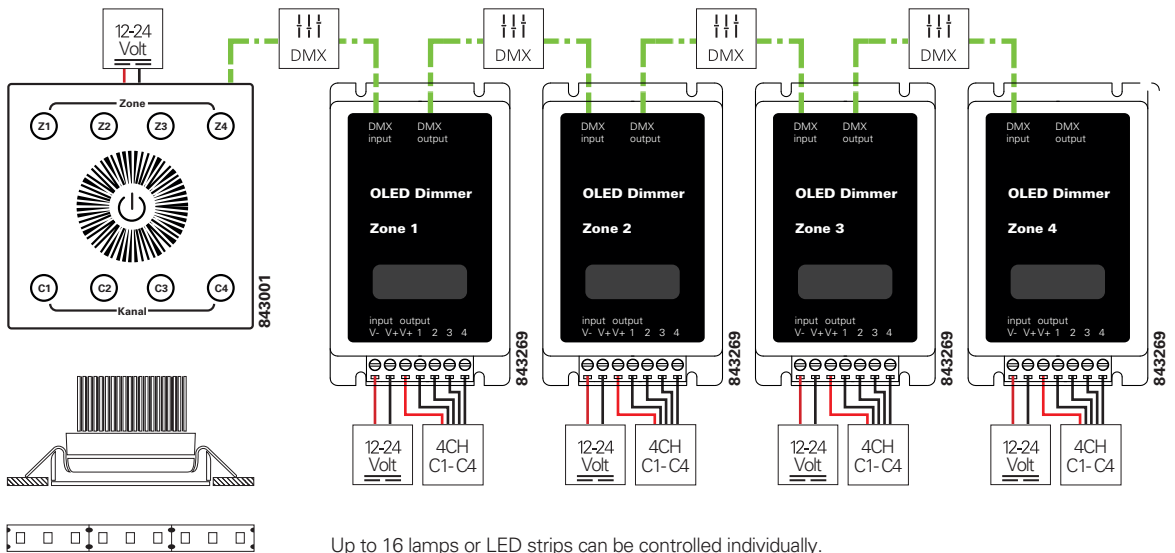

DEKO-LIGHT LED DMX TOUCH 16C

The LED DMX TOUCH 16C is provided with 4 zones with 4 channels each. In total, 16 single channels are available. At the selection of one of the zones (Z1-Z4), the touchwheel controls all 4 channels of this zone. At the selection of one channel (C1-C4) in one zone, the touchwheel controls this selected channel. If neither a zone nor a channel is selected, the touchwheel controls all zones, including their channels. Please note that the controller was specifically designed for warm and/or cold white end devices. By its functions, it is only conditionally implemented for RGB or RGBW end devices.



- background illumination and touch signal tone optionally connectable
- memory function: the DMX Touch 16C memorizes the most recent brightness setting of all zones and channels
- DMX out: CAT5 [RJ45] opt. connection terminals
- dimensions L x W x H: 86 x 86 x 17,4 mm

843001 ■ black

129,95 €



accessories

872128 power supply Mini 24V/4W

11,95 €



DEKO-LIGHT ART 4 | RGB/RGBW

The ART 4 controller is a touch panel for playing and editing colour programs, specifically for RGBW end devices. Up to 4 atmospheres and up to 4 scenes can be saved and retrieved. The ART-4 contains 4 function menus: Selection of integrated programs, colour, brightness, speed setting. Scenes and atmospheres are created in a quick and userfriendly manner. As a design element, the ART 4 controller is ideally suited in the environment and is an appropriate choice both for hotels and auditoriums and the home and living space.

- PWM out for the direct control of LED stripes
- control element and controller via touchwheel
- fade times of 0-4 seconds possible
- DMX out / DC in: connection terminals
- dimensions L x W x H: 86 x 86 x 15,3 mm
- integrated PWM dimmer 12/24V, 4 x 2A

843000 ■ black

189,95 €



DEKO-LIGHT ART 9 | RGB/RGBW

The ART 9 controller is a touch panel for playing and editing colour programs, specifically for RGBW end devices. Up to 9 atmospheres and up to 9 scenes can be saved and retrieved. The ART-4 contains 4 function menus: Selection of integrated programs, colour, brightness, speed setting. Scenes and atmospheres are created in a quick and userfriendly manner. As a design element, the ART 9 controller is ideally suited in the environment and is an appropriate choice both for hotels and auditoriums and the home and living space.

- PWM out for the direct control of LED stripes
- control element and controller via touchwheel
- fade time setting for switch on/off and colour change
- function memory and power failure protection
- DMX out / DC in: connection terminals
- dimensions L x W x H: 172 x 86 x 15,3 mm
- integrated PWM dimmer 12/24V, 4 x 2A

843003 ■ black

219,95 €



accessories

872128 power supply Mini 24V/4W

11,95 €

accessories

872128 power supply Mini 24V/4W

11,95 €



DEKO-LIGHT X-FADE-6

The X-Fade 6 is a modern wall controller on the DMX basis for LED dimmers. Up to 6 faders can be directly controlled and connected to RGB dimmers. For example, 2 RGB stripes are addressed and also 6 single one-colour stripes can be controlled in 6 different zones. The X-Fade 6 is further used as a standard 6 channel DMX Controller, which enables the control of DMX dimmers or devices with up to 6 channels. Additionally, up to 6 different programs can be retrieved. Each program can contain up to 100 steps. Programs can also be controlled automatically. [A mounting box is required for the assembly of the controller.]

- incl. IR-remote control
- 6 programmable scenes
- fade time setting
- DMX out / DC in: connection terminals
- dimensions L x W x H: 86 x 86 x 16,3 mm

861203 ■ black

184,95 €



accessories

872128 power supply Mini 24V/4W

11,95 €



EUROLITE DMX-CONTROLLER LED COLOR CHIEF

The COLOR CHIEF is an innovative and easy to use DMX controller, which is optimally tailored to the needs and requirements of gastronomy, bars, event locations, event rooms, etc. . It is suitable for controlling e. g. LED stripes, lights, spotlights, light effects and all other components with 1-6 colours [WW, CW, WW-CV, RGB, RGBW, RGBWAUV] or

up to 30 channels, which can be controlled with DMX via corresponding controller/dimmer. 24 different and directly selectable scene buttons allow access to previously stored lighting scenes or program sequences. The USB interface can be used to save the created programming to a USB memory stick and, if necessary, to restore it.

- easy control of LED stripes, lights, headlights or similar with 1-6 colors or simple lighting effects with up to 30 channels
- for up to 8 different device groups/zones
- fast and easy programming
- extensive, already pre-installed device library with many common applications
- additional devices can be easily added manually
- 8 colour effects directly selectable
- three additional channels are freely assignable per device [e.g. for special functions, movements, etc.]
- colour wheel selection
- 24 memory slots for permanently stored lighting moods
- USB port for data storage / restoration of programming
- clock control with programmed chases via music signal
- total dimming, fade time between individual scenes comfortably adjustable
- 3-pin XLR connector
- firmware-Update via USB
- operation as rack installation [19 "/ 3 height units] or desktop unit
- control: DMX / max. 240 channels
- power supply: power cable with power adapter [included]
- weight: 2,2 kg
- protection class: IP20
- connection power: 10 W
- dimensions L x W x H: 483 x 132 x 85 mm

843047 ■ black

329,95 €



accessories

882271 adapter DMX plug to CAT5

49,95 €



EUROLITE DMX-CONTROLLER LED EASY DELUXE

The LED EASY DELUXE is a very simple and intuitive DMX controller that can be used for a wide range of applications. No matter if commercial or private, wherever LED stripes, lights, spotlights with 1-6 colours [WWW, CW, WWW-CW, RGB,

- easy control of LED stripes, lamps, spotlights etc. with 1-6 colours
- for up to 4 different device groups/zones
- quick and easy commissioning thanks to pre-installed programs
- single DMX channels for red, green, blue, white, amber and UV
- 12 memory slots for permanently stored lighting moods
- 4 colour controls with 12 colours each
- 4 brightness controls

RGBW, RGBW-A-UV] and DMX are controlled via corresponding controller/dimmer, this new DXM controller finds its application. It is very easy to directly select 12 different stored light moods/scenes using a rotary control.

- function buttons for blackout, auto, music control and strobe effect
- fader for overall brightness, sequence and fade time
- 3-pin XLR connector
- operation as a tabletop device or built-in device
- control: DMX / max. 24 channels
- power supply: power cable with power adapter [included]
- weight: 1,2 kg
- protection class: IP20
- connection power: 10 W
- dimensions L x W x H: 260 x 140 x 65 mm

843046 ■ black

159,95 €



accessories

882271 adapter DMX plug to CAT5

49,95 €

DEKO-LIGHT OLED DMX DIMMER 3

**3 channels all-in-one PWM dimmer
with 3 different operating modes:**

- **DMX control**
- **standalone Programme mode**
- **standalone dimmer mode**
- to be used as a 1 or 3 channel dimmer
- a manual mode allows the single dimming of the 3 channels on the device [colour setting]
- incl. 27 colour change programs
- Master/Slave function
- all settings are retrieved via a simple menu on a LCD display
- DMX signal pluggable via CAT5 [2m patch cable included in delivery]
- dimensions L x W x H: 116 x 57 x 23,8 mm
- max. 6A each channel
- power: 3x 72W [216W] at 12V,
3x 144W [432W] at 24V



843268 ■ black **89,95 €**



DEKO-LIGHT OLED DMX DIMMER 4

**4 channels all-in-one PWM dimmer
with 3 different operating modes:**

- **DMX control**
- **standalone Programme mode**
- **standalone dimmer mode**
- to be used as a 1, 2 or 4 channel dimmer
- a manual mode allows the single dimming of the 4 channels on the device [colour setting]
- incl. 13 colour change programs
- Master/Slave function
- all settings are retrieved via a simple menu on a LCD display
- DMX signal pluggable via CAT5 [2m patch cable included in delivery]
- dimensions L x W x H: 116 x 57 x 23,8 mm
- max. 6A each channel
- power: 4x 60W [240W] at 12V,
4x 120W [480W] at 24V



843269 ■ black **99,95 €**



DEKO-LIGHT LED DMX DIMMER 2

- simple and powerful 1-2 channel dimmer
- to be used as a single device or in connection with a control panel in an assembly
- flicker free
- connection: terminals
- control: DMX, 0-10V, manual, automatic
- dimensions L x W x H: 115 x 57 x 25 mm
- max. 6A each channel
- power: 2x 72W [144W] at 12V,
2x 144W [288W] at 24V



843336 ■ black **69,95 €**



DEKO-LIGHT LED DMX DIMMER 3

- simple and powerful 3 channel dimmer
- to be used as a single device or in connection with a control panel in an assembly
- flicker free
- connection: terminals
- control: DMX, manual, automatic
- dimensions L x W x H: 115 x 57 x 25 mm
- max. 4A each channel
- power: 3x 48W [144W] at 12V,
3x 96W [288W] at 24V



843335 ■ black **74,95 €**



DEKO-LIGHT LED DMX DIMMER 4

- simple and powerful 4 channel dimmer
- to be used as a single device or in connection with a 4 channels DMX wall controller
- flicker free
- connection: terminals
- control: DMX, manual, automatic
- dimensions L x W x H: 115 x 57 x 25 mm
- max. 3A each channel
- power: 4x 36W [144W] at 12V,
4x 72W [288W] at 24V



843337 ■ black **79,95 €**



DEKO-LIGHT R-DMX 3+1

RDM means »Remote Device Management«. This remote device management enables the control of the RDMX 3+1 from the control panel. This provides a great advantage, specifically for inaccessible installations or sites that are difficult to reach. If RDM is not available, the DMX address assignment can also be set manually via the DIP switch.

- complies with the DMX 512/1990, RDM protocol/2009
- supports automatic DMX addressing
- incl. top-hat rail adapter
- incl. 2m CAT5 cable [RJ45]
- flicker free
- connection: terminals
- dimensions L x W x H: 120 x 43 x 23 mm
- max. 4A each channel
- power: 4x 48W [192W] at 12V,
4x 96W [384W] at 24V

843273 ■ black

79,95 €



DEKO-LIGHT 4 CHANNEL LED DMX DIMMER 12-48V

- simple and powerful 4 channel dimmer
- RDM capable with compatible controllers [remote configuration, e.g. DMX address]
- use in conjunction with DMX wall controller or DMX512 PC software
- flicker free
- connection DMX in/out: CAT5 or terminal
- connection DC in/out: terminal
- dimensions L x W x H: 140 x 50 x 26 mm
- max. 4A each channel
- power: 4x 48W [192W] at 12V,
4x 96W [384W] at 24V,
4x 192W [768W] at 48V

843060 ■ black

89,95 € **new**



NETZTEIL MIT INTEGRIERTEM 3-KANAL-DMX-DIMMER

- compact DMX combi device for simple and quick installation
- powerful 3 channel dimmer and power supply combined in one housing
- controlled with all 3 channels DMX control panels
- supports DMX512
- dimmable from 0 - 100%
- soft dimming without flickering
- dimensions L x W x H: 196 x 75 x 40 mm
- power: 3x 45W



843274	■ black	12V	135W	159,95 €
843275	■ black	24V	135W	159,95 €



DEKO-LIGHT LED DMX/R-DMX DIMMER 4 CC

- controls 4 independent constant current [CC] LED-luminaires via all common DMX and RDM DMX controllers
- constant current for each channel individually adjustable from 200 - 1600 mA in 50 mA steps
- output voltage for CC-compatible luminaires: 1 - 42V
- all settings via a simple menu via OLED display
- flicker free
- short-circuit proof and overload protection
- connection via screw terminals
- dimensions L x W x H: 135 x 69 x 36 mm
- power: max. 4x 60W



843054	■ black	104,95 €
---------------	---------	-----------------





DALI LED PWM-DIMMER 1/2 CHANNEL

- for controlling 1-2 channel LED stripes [single, WW/CW components]
- dimmable via Dali Bus according to IEC 62386 / Device Type DT6
- overload / short circuit indication / switch-off
- dimensions L x W x H: 167 x 51 x 23 mm
- max. 5A each channel
- power: 2x 120W (240W) at 12 V,
2x 240W (480W) at 24 V

843051 white 99,95 €

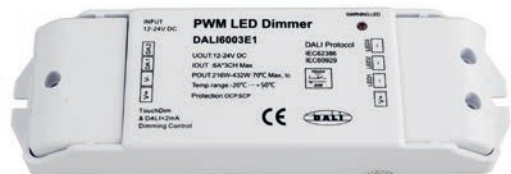

DALI LED PWM-DIMMER 3 CHANNEL

- for controlling 3 channel LED stripes [RGB components]
- dimmable via Dali Bus according to IEC 62386 / Device Type DT6
- overload / short circuit indication / switch-off
- dimensions L x W x H: 167 x 51 x 23 mm
- max. 6A each channel
- power: 3x 72W (216W) at 12 V,
3x 144W (432W) at 24 V

843052 white 104,95 €





DALI LED PWM-DIMMER 4 CHANNEL

- for controlling 1-4 channel LED stripes [single, WW/CW, RGB, RGBW components]
- dimmable via Dali Bus according to IEC 62386 / Device Type DT6
- overload / short circuit indication / switch-off
- dimensions L x W x H: 167 x 51 x 23 mm
- max. 5A each channel
- power: 4x 60W (240W) at 12V,
4x 120W (480W) at 24V

843010 white **114,95 €**



With the kind support of SH-Lichttechnik, Pfullingen und Becks Reutlingen





G4
page 966



G4
page 966



MR16/GU5,3
page 967



MR16/GU5,3
page 967

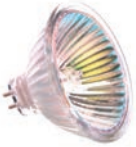

MR16/GU5,3
page 968



MR16/GU5,3
page 968



GU10
page 969



GU10
page 969



GU10
page 970



GU10
page 970



GU10/ES111
page 971



E14
page 972



E14
page 972



E14
page 972



E27
page 973



E27
page 973



E27
page 973



E27
page 974



E27
page 974



E27
page 974



E27
page 975



E27
from page 975



E27
page 976



E27
page 977



G9
page 978



G53/QR111
page 978



GX53
page 978



R7S
page 979



R7S
page 979



fluorescent
lamp
page 980



metal halide
lamps
page 981



metal halide
lamps
page 982



metal halide
lamps
page 982



metal halide
lamps
page 983

light sources

PHILIPS COREPRO LEDCAPSULELV 2.5-28W827

- plastic
- dimensions L x Ø: 46,5 x 15 mm

180135 silver coloured 2700 K 2,5 W 300 lm 120° EEL: A++ 3 kWh/1000h **16,95 €**



OSRAM PARATHOM LED PIN G4 12V1,8W827

- plastic
- dimensions L x Ø: 36 x 13 mm

180134 weiß 2700 K 1,8 W 200 lm 300° EEL: A++ 2 kWh/1000h **12,95 €**



PARATHOM MR16 20 36° 2,6W

- glass
- dimensions L x Ø: 46 x 51 mm

180167		colourless	3000 K	2,6 W	230 lm	36°	EEL: A++	3 kWh/1000h	11,95 €
180183		colourless	4000 K	2,6 W	230 lm	36°	EEL: A++	3 kWh/1000h	11,95 €



PARATHOM MR16 35 36° 3.8W

- glass
- dimensions L x Ø: 46 x 51 mm

180177		colourless	3000 K	3,8 W	350 lm	36°	EEL: A++	5 kWh/1000h	11,95 €
180175		colourless	4000 K	3,8 W	350 lm	36°	EEL: A++	3 kWh/1000h	11,95 €



PARATHOM MR16 DIM 20 36° 3,4W

- glass
- dimensions L x Ø: 46 x 51 mm

180176		colourless	3000 K	3,4 W	230 lm	36°	EEL: A+	4 kWh/1000h	14,95 €
180133		colourless	4000 K	3,4 W	230 lm	36°	EEL: A+	4 kWh/1000h	14,95 €



PARATHOM MR16 DIM 35 36° 4,9W



- glass
- dimensions L x Ø: 46 x 51 mm

180168		colourless	3000 K	4,9 W	350 lm	36°	EEL: A+	6 kWh/1000h	18,95 €
180174		colourless	4000 K	4,9 W	350 lm	36°	EEL: A+	4 kWh/1000h	15,95 €



OSRAM DECOSTAR 51S

- glass
- dimensions L x Ø: 45 x 51 mm
- dimmable via optional power supply unit

290020	<input checked="" type="checkbox"/>	colourless	 3000 K	20,0 W	210 lm	36°	EEL: B	22 kWh/1000h	2,95 €
290035	<input checked="" type="checkbox"/>	colourless	 2900 K	35,0 W	430 lm	36°	EEL: B	38 kWh/1000h	2,95 €
290050	<input checked="" type="checkbox"/>	colourless	 2950 K	50,0 W	680 lm	36°	EEL: B	53 kWh/1000h	2,95 €



OSRAM DECOSTAR

- glass
- dimensions L x Ø: 46 x 50 mm
- dimmable via optional power supply unit
- up to 30% energy savings

48860W	<input checked="" type="checkbox"/>	colourless	 3000 K	20,0 W	300 lm	36°	EEL: B	22 kWh/1000h	8,95 €
48865W	<input checked="" type="checkbox"/>	colourless	 3000 K	35,0 W	625 lm	38°	EEL: B	38 kWh/1000h	8,95 €
48860VW	<input checked="" type="checkbox"/>	colourless	 3000 K	20,0 W	300 lm	60°	EEL: B	22 kWh/1000h	8,95 €
48865VW	<input checked="" type="checkbox"/>	colourless	 3100 K	35,0 W	620 lm	60°	EEL: B	38 kWh/1000h	8,95 €
48870VW	<input checked="" type="checkbox"/>	colourless	 3000 K	50,0 W	870 lm	60°	EEL: B	53 kWh/1000h	8,95 €



OSRAM DECOSTAR TITAN

- glass
- dimensions L x Ø: 46 x 50 mm
- dimmable via optional power supply unit

46860W	<input checked="" type="checkbox"/>	colourless	 3000 K	20,0 W	250 lm	36°	EEL: B	22 kWh/1000h	4,95 €
46865W	<input checked="" type="checkbox"/>	colourless	 3000 K	35,0 W	550 lm	36°	EEL: B	38 kWh/1000h	4,95 €





PHILIPS MASTER VALUE LED SPOT GU10

- glass
- dimensions L x Ø: 54 x 50 mm
- dimmable

180139	<input type="checkbox"/>	silver coloured	<input checked="" type="checkbox"/> ww	3000 K	6,2 W	575 lm	36°	EEL: A++	7 kWh/1000h	18,95 €
180149	<input type="checkbox"/>	silver coloured	<input checked="" type="checkbox"/> nw	4000 K	6,2 W	575 lm	36°	EEL: A++	7 kWh/1000h	16,95 €



PHILIPS MASTER VALUE LED SPOT GU10

- glass
- dimensions L x Ø: 54 x 50 mm
- dimmable

180049	<input type="checkbox"/>	silver coloured	<input checked="" type="checkbox"/> ww	2700 K	4,9 W	355 lm	60°	EEL: A+	5 kWh/1000h	13,95 €
180050	<input type="checkbox"/>	silver coloured	<input checked="" type="checkbox"/> ww	3000 K	4,9 W	365 lm	60°	EEL: A+	5 kWh/1000h	13,95 €
180051	<input type="checkbox"/>	silver coloured	<input checked="" type="checkbox"/> nw	4000 K	4,9 W	380 lm	60°	EEL: A+	5 kWh/1000h	13,95 €
180052	<input type="checkbox"/>	silver coloured	<input checked="" type="checkbox"/> ww	2700 K	4,9 W	355 lm	36°	EEL: A+	5 kWh/1000h	13,95 €
180099	<input type="checkbox"/>	silver coloured	<input checked="" type="checkbox"/> ww	3000 K	4,9 W	365 lm	36°	EEL: A+	5 kWh/1000h	13,95 €
180053	<input type="checkbox"/>	silver coloured	<input checked="" type="checkbox"/> nw	4000 K	4,9 W	380 lm	36°	EEL: A+	5 kWh/1000h	13,95 €



PHILIPS MASTER VALUE DT LED SPOT GU10

- glass
- dimensions L x Ø: 54 x 50 mm

Dimming changes the colour temperature from 2700 to 2000 K.

180109	<input type="checkbox"/>	silver coloured	<input checked="" type="checkbox"/> ww	2000 - 2700 K	3,7 W	260 lm	36°	EEL: A+	4 kWh/1000h	15,95 €
180113	<input type="checkbox"/>	silver coloured	<input checked="" type="checkbox"/> ww	2000 - 2700 K	4,9 W	355 lm	36°	EEL: A+	4 kWh/1000h	16,95 €

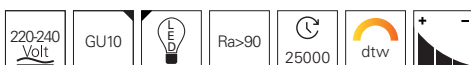



PHILIPS MAS LED SPOT VLE D 3.7-35W GU10

- glass
- dimensions L x Ø: 54 x 50 mm
- dimmable via leading or trailing edge

180080  silver coloured  2700 K 3,7 W 260 lm 36° EEL: A+ 4 kWh/1000h **10,95 €**



OSRAM PARATHOM PAR 16 50 36° 4.3 W/827

- glass
- dimensions L x Ø: 55 x 51 mm

180081  silver coloured  2700 K 4,3 W 350 lm 36° EEL: A 5 kWh/1000h **5,95 €**



PARATHOM DIM PAR16 80 36° 8.3W /2700K GU10

- glass
- dimensions L x Ø: 52 x 50 mm
- dimmable



180178  silver coloured  2700 K 8,3 W 550 lm 36° EEL: A 9 kWh/1000h **14,95 €**





ISOLED ES111 GU10 COB SPOT

- glass
- dimensions L x Ø: 63,5 x 111 mm
- dimmable via leading or trailing edge

180166  silver coloured  2700 K

13 W 1050 lm 75° EEl: A+ 14 kWh/1000h **82,95 €**



LED ES111 COB 4200K

- aluminium diecast
- dimensions L x Ø: 63,5 x 111 mm

180163  grey  4200 K

13 W 1400 lm 75° EEl: A++ 13 kWh/1000h **79,95 €**





PHILIPS CLA LEDCANDLE ND 4.3-40W E14 827 B35 FR

- glass
- dimensions L x Ø: 104 x 35 mm

180165 milky 2700 K 4,3 W 470 lm 360° EEL: A++ 5 kWh/1000h **8,95 €**



CLASSIC LEDCANDLE DT4.5-40W E14 CRI90 B35CL

- glass
- dimensions L x Ø: 99 x 35 mm
- dimmable via leading or trailing edge

180186 colourless 2200-2700 K 4,5 W 470 lm 270° EEL: A++ 5 kWh/1000h **12,95 €**



PHILIPS MAS LEDLUSTRE E14 6-40W

- dimensions L x Ø: 95 x 48 mm
- dimmable via leading or trailing edge

180098 colourless 2700 K 6,0 W 470 lm EEL: A+ 6 kWh/1000h **13,95 €**





CLASSIC LEDLUSTER DT4.5-40W P45 E27 CL

- glass
- dimensions L x Ø: 80 x 45 mm
- dimmable

180188  colourless  2200-2700 K 4,5 W 470 lm 270° EEl: A++ 5 kWh/1000h **15,95 €**



MAS LEDSPOT CLA 9,5W 25° E27 760LM 3000K

- glass
- dimensions L x Ø: 88 x 96 mm
- dimmable

180179  colourless  3000 K 9,5 W 760 lm 25° EEl: A+ 10 kWh/1000h **32,95 €**



MASTER LEDSPOT PAR 30 840

- glass
- dimensions L x Ø: 88 x 96 mm
- dimmable

180187  colourless  4000 K 9,5 W 820 lm 25° EEl: A+ 10 kWh/1000h **32,95 €**



PARATHOM RETROFIT P CLAS A 60 7W/2700K DIM

- glass
- dimensions L x Ø: 105 x 60 mm
- dimmable

180169  colourless  2700 K 7,0 W 806 lm 360° EEL: A++ 7 kWh/1000h **10,95 €**



CLASSIC LEDLUSTER DT3.2-25W P45 E27 CL

- glass
- dimensions L x Ø: 80 x 45 mm
- dimmable

180173  colourless  2200-2700 K 3,2 W 250 lm 360° EEL: A+ 4 kWh/1000h **5,95 €**



COREPRO LEDBULB D5.5-40W A60

- glass
- dimensions L x Ø: 110 x 60 mm
- dimmable

180159  milky  2700 K 5,0 W 470 lm 150° EEL: A+ 5 kWh/1000h **12,95 €**





DEKO-LIGHT LIGHT SOURCES FILAMENT E27 A60

- glass
- dimensions L x Ø: 105 x 60 mm
- dimmable via leading or trailing edge

180054	<input checked="" type="checkbox"/>	colourless	2700 K	4,4 W	450 lm	300°	EEL: A+	5 kWh/1000h	7,95 €
180055	<input type="checkbox"/>	milky	2700 K	4,4 W	410 lm	300°	EEL: A+	5 kWh/1000h	7,95 €
180057	<input type="checkbox"/>	milky	2700 K	8,5 W	930 lm	300°	EEL: A+	9 kWh/1000h	11,95 €



DEKO-LIGHT LIGHT SOURCES FILAMENT E27 G95

- glass
- dimensions L x Ø: 140 x 95 mm
- dimmable via leading or trailing edge

180058	<input checked="" type="checkbox"/>	colourless	2700 K	4,4 W	450 lm	300°	EEL: A+	5 kWh/1000h	10,95 €
180059	<input type="checkbox"/>	milky	2700 K	4,4 W	410 lm	300°	EEL: A+	5 kWh/1000h	10,95 €
180060	<input checked="" type="checkbox"/>	gold optics	2200 K	4,4 W	380 lm	300°	EEL: A+	5 kWh/1000h	13,95 €
180061	<input checked="" type="checkbox"/>	colourless	2700 K	8,5 W	1010 lm	300°	EEL: A+	9 kWh/1000h	15,95 €
180062	<input type="checkbox"/>	milky	2700 K	8,5 W	930 lm	300°	EEL: A+	9 kWh/1000h	15,95 €
180063	<input checked="" type="checkbox"/>	gold optics	2200 K	8,5 W	860 lm	300°	EEL: A+	9 kWh/1000h	19,95 €





DEKO-LIGHT LIGHT SOURCES FILAMENT E27 G125

- glass
- dimensions L x Ø: 173 x 125 mm
- dimmable via leading or trailing edge

180064		colourless		2700 K	4,4 W	450 lm	300°	EEL: A+	5 kWh/1000h	13,95 €
180065		milky		2700 K	4,4 W	410 lm	300°	EEL: A+	5 kWh/1000h	13,95 €
180066		gold optics		2200 K	4,4 W	380 lm	300°	EEL: A+	5 kWh/1000h	17,95 €
180067		colourless		2700 K	8,5 W	1010 lm	300°	EEL: A+	9 kWh/1000h	19,95 €
180068		milky		2700 K	8,5 W	930 lm	300°	EEL: A+	9 kWh/1000h	19,95 €
180069		gold optics		2200 K	8,5 W	860 lm	300°	EEL: A+	9 kWh/1000h	21,95 €



DEKO-LIGHT LIGHT SOURCES FILAMENT E27 ST64

- glass
- dimensions L x Ø: 145 x 64 mm
- dimmable via leading or trailing edge

180070		gold optics		2200 K	4,4 W	380 lm	300°	EEL: A+	5 kWh/1000h	10,95 €
180071		gold optics		2200 K	8,5 W	860 lm	300°	EEL: A+	9 kWh/1000h	13,95 €



DEKO-LIGHT LED E27 RF RGBW MIT FERNBEDIENUNG

- aluminium diecast
- dimensions L x Ø: 120 x 60 mm
- dimmable via remote control

180136  silver coloured  3000 K

8 W 520 lm

EEL: A 8 kWh/1000h **53,95 €**





OSRAM HALOPIN

- glass
- dimensions L x Ø: 43 x 14 mm
- dimmable via leading edge
- 20% energy savings

666663		colourless		2700 K	20W	235 lm	360°	EEL: D	20 kWh/1000h	5,95 €
666662		colourless		2700 K	33W	460 lm	360°	EEL: C	33 kWh/1000h	5,95 €
666664		colourless		2800 K	48W	740 lm	360°	EEL: D	48 kWh/1000h	5,95 €



OSRAM HALOSPOT 111

- aluminium
- dimensions L x Ø: 67 x 111 mm
- 20% energy savings

484322		silver coloured		2900 K	35W	440 lm	24°	EEL: B	38 kWh/1000h	21,95 €
488352		silver coloured		3000 K	50W	650 lm	24°	EEL: B	53 kWh/1000h	21,95 €



LED GX53, 6W

- plastic
- dimensions L x Ø: 28 x 75 mm

180184		weiß		2700 K	6W	470 lm	120°	EEL: A+	6 kWh/1000h	15,95 €
180185		silver coloured		4200 K	6W	470 lm	120°	EEL: A+	6 kWh/1000h	15,95 €





PHILIPS COREPRO LED LINEAR R7S 118MM

- dimensions L x Ø: 118 x 29 mm
- dimmable via leading edge

180097  silver coloured  3000 K 14W 1600 lm EEL: A+ 14 kWh/1000h **38,95 €**



OSRAM HALOLINE

- glass
- dimensions L x Ø: 74,9 x 12 mm
- dimmable via leading edge
- 20% energy savings

332269  colourless  2800 K 48W 750 lm EEL: C 48 kWh/1000h **7,95 €**
332270  colourless  2950 K 80W 1400 lm EEL: D 80 kWh/1000h **7,95 €**
332271  colourless  2950 K 120W 2250 lm EEL: C 120 kWh/1000h **7,95 €**



OSRAM HALOLINE

- glass
- dimensions L x Ø: 119,6 x 12 mm
- dimmable via leading edge
- 20% energy savings

332266  colourless  2950 K 230W 5000 lm EEL: C 230 kWh/1000h **7,95 €**





OSRAM FLUORESCENT LAMP T5

- glass
- acceptance only in whole unit of 20 pcs. per wattage

162054	<input type="checkbox"/> milky	NW 4000 K	14W	1200 lm	549 mm	EEL: A+	16 kWh/1000h	6,95 €
162055	<input type="checkbox"/> milky	NW 4000 K	54W	4450 lm	1149 mm	EEL: A+	60 kWh/1000h	6,95 €



OSRAM T8 PLUS FLUORESCENT LAMP

- glass
- acceptance only in whole unit of 25 pcs. per wattage

162044	<input type="checkbox"/> milky	CW 8000 K	18W	1300 lm	590 mm	EEL: A	20 kWh/1000h	9,95 €
162046	<input type="checkbox"/> milky	CW 8000 K	58W	4900 lm	1500 mm	EEL: A	64 kWh/1000h	12,95 €



OSRAM T8 PLUS FLUORESCENT LAMP

- glass
- acceptance only in whole unit of 25 pcs. per wattage

162047	<input type="checkbox"/> milky	NW 4000 K	18W	1350 lm	590 mm	EEL: A	20 kWh/1000h	4,95 €
162048	<input type="checkbox"/> milky	NW 4000 K	58W	5200 lm	1500 mm	EEL: A	64 kWh/1000h	5,95 €



OSRAM HQI-TS POWERSTAR





- glass
- dimensions L x Ø: 117 x 19 mm

071WDL		colourless	 3300 K	70 W	5925 lm	EEL: A	70 kWh/1000h	21,95 €
071NDL		colourless	 4200 K	70 W	6500 lm	EEL: A	70 kWh/1000h	21,95 €
071DDL		colourless	 5600 K	70 W	6200 lm	EEL: A	70 kWh/1000h	21,95 €



OSRAM HQI-TS POWERSTAR

- glass
- dimensions L x Ø: 135 x 23 mm

151WDL		colourless	 3200 K	150 W	12000 lm	EEL: A	150 kWh/1000h	21,95 €
151NDL		colourless	 4200 K	150 W	12500 lm	EEL: A	150 kWh/1000h	21,95 €
151DDL		colourless	 5450 K	150 W	13000 lm	EEL: A	150 kWh/1000h	21,95 €



PHILIPS CDM-TD MASTER COLOUR

- glass
- dimensions L x Ø: 501011: 119,6 x 22 mm
501012: 137,4 x 25 mm



501012		colourless	3000 K	150 W	13250 lm	EEL: A	150 kWh/1000h	37,95 €
501011		colourless	4200 K	70 W	5600 lm	EEL: A	70 kWh/1000h	37,95 €



PHILIPS METALLDAMPFLAMPE MASTERCOLOUR

- glass
- dimensions L x Ø: 137,4 x 25 mm



501013		colourless	4200 K	150 W	14200 lm	EEL: A	150 kWh/1000h	37,95 €
---------------	--	------------	--------	-------	----------	--------	---------------	----------------



PHILIPS CDM-TD MASTER COLOUR

- glass
- dimensions L x Ø: 103 x 20 mm



501000		colourless	3000 K	35 W	3150 lm	EEL: A	35 kWh/1000h	39,95 €
501001		colourless	3000 K	70 W	6600 lm	EEL: A	70 kWh/1000h	39,95 €
501003		colourless	3000 K	150 W	14000 lm	EEL: A+	150 kWh/1000h	39,95 €
501008		colourless	4200 K	35 W	3300 lm	EEL: A	35 kWh/1000h	39,95 €
501002		colourless	4200 K	70 W	6600 lm	EEL: A	70 kWh/1000h	39,95 €
501004		colourless	4200 K	150 W	12700 lm	EEL: A	150 kWh/1000h	39,95 €





VENTURE LIGHTING HALOGEN-METALLDAMPFLAMPE 250 W KLAR

- glass
- dimensions L x Ø: 245 x 46 mm

501033  colourless  4000 K 250 W 18300 lm EEl: A 264 kWh/1000h **69,95 €**



VENTURE LIGHTING HALOGEN-METALLDAMPFLAMPE 400 W KLAR

- glass
- dimensions L x Ø: 296 x 120 mm

501032  colourless  4000 K 400 W 41000 lm EEl: A 264 kWh/1000h **79,95 €**





indoor dimming
from page 986



indoor dimming and switching
page 988



indoor miscellaneous
page 989



indoor low voltage
page 991



indoor low voltage connectors
from page 992



outdoor low voltage WEIPU HQ connectors
from page 995



indoor / outdoor DMX cable
page 998



indoor high voltage
page 1000



indoor high voltage connector systems
page 1001



outdoor high voltage connector systems
page 1002



outdoor cable connectors
from page 1004



outdoor miscellaneous
page 1007



outdoor mounting accessories
page 1008

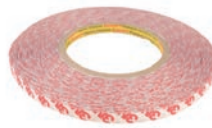

indoor / outdoor mounting material for LED stripes und profiles
page 1009



indoor / outdoor mounting accessories
from page 1010



sales assistance sample case
from page 1012

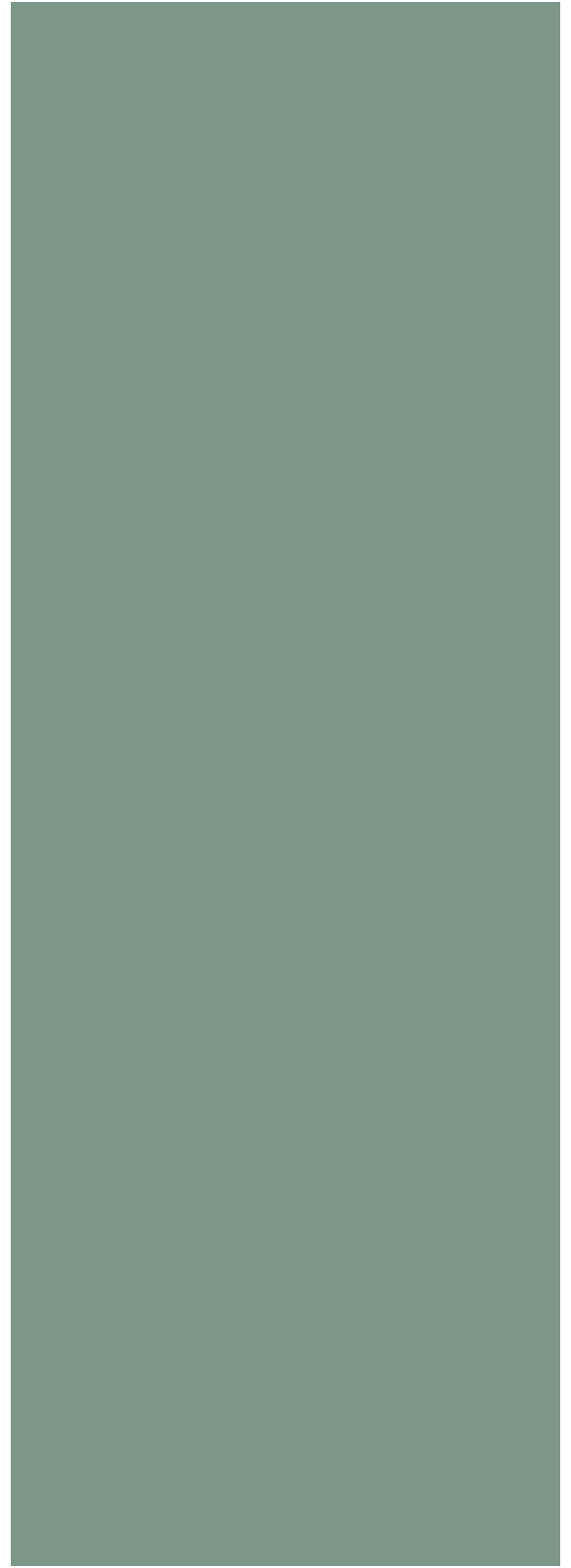

accessories

DIMMER | LEADING EDGE

suitable for dimming of:

- R loads [light sources] 20 - 500 W
- L loads [conventionally wound transformers] 20 - 500 W
- max. 5 electronical ballasts
- suitable for 68 mm floating boxes

100484 white

69,95 €



DIMMER | TRAILING EDGE

suitable for dimming of:

- R loads [light sources] 10 - 350 W
- C-Lasten [elektrische electronical ballasts] 10 - 350 W
- max. 5 electronical ballasts
- adjustable minimum load / brightness
- perfectly maTCHED TO DEKO-LIGHT power supply
- suitable for 68 mm floating boxes

930060 white

59,95 €



DIMMING VIA LEADING / TRAILING EDGE

Please always ensure that the dimmer used is suitable for new installations and especially when retrofitting existing systems. You will find information on the housing as well as in the technical data sheets for which type of load, power and quantity of ballasts they are suitable.

types of electrical loads:

[R] = Ohmic load = light bulb, high-voltage halogen etc.

[L] = Inductive load* = Wound transformers

[C] = Capacitive load* = High voltage LED, all electrical transformers.

* Unless otherwise stated, max. 5 [C-load] or 2 [L-load] ballasts/lamps per dimmer.

You would like to dim and switch 230V components from several locations, but do not have the required number of cores in the existing installation? Then the following

universal dimmer switches are ideally suited for simple and problem-free integration for both existing and new installations.

ELTAKO DIMMER UNIVERSAL 400W EUD12NPN-UC

- control via standard pushbutton
[control voltage 10V-230V AC+DC]
- short keys [on / off], long keys [dimming 0-100-0%]
- suitable for R-L-C loads up to 400W, high voltage LEDs up to 100W, automatic load detection, memory-function, adjustable minimum load and dimming speed
- dimensions L x W x H: 20 x 90 x 70 mm

843042  blue **99,95 €**



ELTAKO DIMMER UNIVERSAL 400W EUD61NPN-UC

- control via standard pushbutton
[control voltage 10V-230V AC+DC]
- short keys [on / off], long keys [dimming 0-100-0%]
- suitable for R-L-C loads up to 400W, high voltage LEDs up to 100W, automatic load detection, memory-function, adjustable minimum load and dimming speed
- installation in junction box possible
- dimensions L x W x H: 45 x 45 x 18 mm

843043  blue **94,95 €**



ELTAKO LED-DIMMSCHALTER ELD61/12-36V

- control via standard pushbutton
[control voltage 10V-230V AC+DC]
- short keys [on / off], long keys [dimming 0-100-0%]
- suitable for 12V/24V/36V LED stripes and dimmable LED lamps
- power 48W bei 12V, 96W at 24V
- soft-off for lamp protection
- memory-function, adjustable minimum brightness / dimming speed
- dimensions L x W x H: 45 x 45 x 18 mm

843033  blue **89,95 €**



ELTAKO CONTROL DIM SWITCH SDS61/1-10V

- control via standard pushbutton [control voltage 230V], that generates a 1-10V control signal [max. 40 mA] at the output
- short keys [on / off], long keys [dimming 0-100-0%]
- suitable for dimmable power supply mit 1-10V control input
- switching output [ECG on / off] memory-function and adjustable dimming speed
- dimensions L x W x H: 45 x 45 x 33 mm

843044 ■ blue

89,95 €

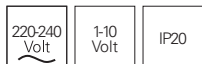

HIGH FREQUENCY MOTION SENSOR | MD1200

- angle of coverage 360°
- detection range 1 - 10 m
- switching time 5 sec - 30 min
- daylight threshold 5 - 2000 Lux
- suitable for switching all common illuminants / electronical ballast [R- / L- / C-loads]
- max. 5 electronical ballasts
- dimensions L x W x H: 75 x 42 x 28 mm

930036 □ white

37,95 €



MAGIC SWITCH

The MAGIC SWITCH is the invisible switch for a variety of applications. Mounted on a plate back or incorporated into a blind hole, it detects the movement taking place on the front of the plate and switches. The MAGIC SWITCH works only in connection with non-metallic surfaces and materials such as wood, glass, ceramics up to a material thickness of 19 mm.

920132 ■ black

69,95 €



ELTAKO RC ELEMENT THREE-WAY RC12-230V

By inductive interference voltages on control and power lines, there is an increasing number of undesirable effects that linear LED lights, which have a very low power consumption, permanently glow or flash due to the design. By installing the RC extinguishing element in the electrical distributor [connection N, L1, L2, L3] inductive interference voltages are compensated / suppressed.

• dimensions L x W x H: 20 x 90 x 70 mm

843045 ■ blue

56,95 €



SURGE PROTECTION MIT KONTROLLANZEIGE

Compact overvoltage protection that effectively prevents the premature failure of LED lights due to problems in power grids. For protection of 1-phase operated, non-dimmable LED lighting systems. Control LED to indicate correct operation. Depending on the connection there is the possibility of load circuit disconnection in case of a fault. IP67 design for direct installation in luminaires or upstream in junction boxes.

• plastic

• dimensions L x W x H: 37 x 30 x 20 mm

843055 ■ black

19,95 € **new**

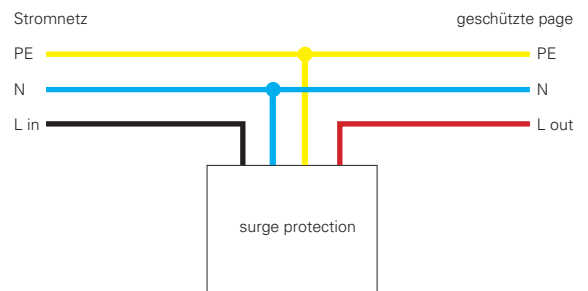
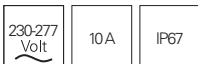

DISTANCE SPACER

• for ceiling mounting rings from Ø 62 to 90 mm

• height 80 mm

829063 ■ black

5,95 €

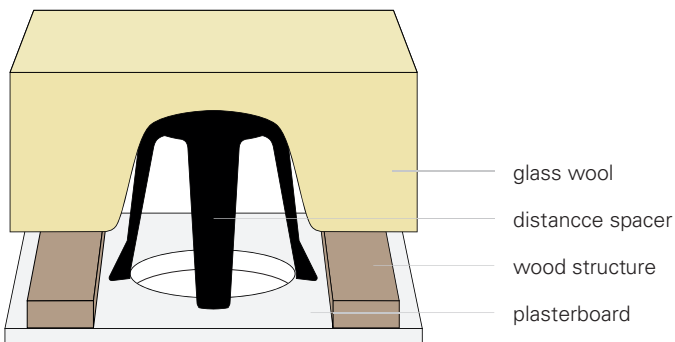



GU5,3 SOCKET

- ceramics
- thermo resistant connection cable

100200 white 15 cm connection cable **0,95 €**

100250 white 50 cm connection cable **1,95 €**



LOW VOLT SCREW DISTRIBUTOR SIX-WAY

- for fast cabling of up to 6 voltage-stable [CV] components on one power supply
- dimensions L x W: 63,5 x 26,0 mm
- 25 cm connection cable

930006 white **8,95 €**



CONNECTING DISTRIBUTOR LED3050

- for fast cabling of up to 2 constant-stable [CC] components on one power supply for series connecting
- 3x 2 connectings 0,34 - 0,5 mm²
- dimensions H x Ø: 11 x 35 mm

930001 white **2,95 €**



AMP-STECKVERTEILER 6-FACH

- 2-pole version
- with quick connector / lock
- cable H03 VVH2-F 2x 0,75 mm²
- 10 cm connection cable

053001 white

4,95 €



AMP EXTENSION LINE

- 2-pole version
- with quick connector / lock
- cable H03 VVH2-F 2x 0,75 mm²

050100 white 100 cm

3,95 €

050200 white 200 cm

4,95 €



AMP PLUG WITH GU5,3 SOCKET

- 2-pole version
- with quick connector / lock
- 13 cm connection cable

050222 white

3,95 €



MINI-AMP CONNECTION CABLE | EXTENSION CABLE

- 2-pole version
- ready-to-plug-in installation of pre-assembled component
- simple and reverse polarity protected installation

940032	<input type="checkbox"/>	white	connection cable - plug	30 cm	2,95 €	new
940036	<input type="checkbox"/>	white	connection cable - plug	100 cm	3,95 €	new
940040	<input type="checkbox"/>	white	connection cable - plug	200 cm	4,95 €	new
940044	<input type="checkbox"/>	white	extension - plug/socket	50 cm	5,95 €	new
940048	<input type="checkbox"/>	white	extension - plug/socket	100 cm	6,95 €	new
940052	<input type="checkbox"/>	white	extension - plug/socket	200 cm	7,95 €	new

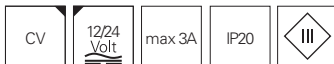

MINI-AMP MULTIPLE DISTRIBUTOR | PLUG - SOCKET

- 2-pole version
- ready-to-plug-in installation of pre-assembled component
- simple and reverse polarity protected installation

940064	<input type="checkbox"/>	white	3-fach / 20 cm connection cable	1x plug, 3x socket	6,95 €	new
940065	<input type="checkbox"/>	white	6-fach / 20 cm connection cable	1x plug, 6x socket	7,95 €	new

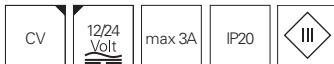

MINI-AMP INSERT SWITCH | PLUG - SOCKET

- 2-pole version
- ready-to-plug-in installation of pre-assembled component
- simple and reverse polarity protected installation

940066	<input type="checkbox"/>	white		2x 100 cm	12,95 €	new
---------------	--------------------------	-------	--	-----------	----------------	------------

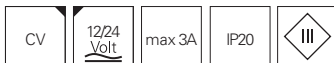

MINI-AMP ADAPTER MR16/GU5,3 | SOCKET - PLUG

- 2-pole version
- ready-to-plug-in installation of pre-assembled component
- simple and reverse polarity protected installation

940067	<input type="checkbox"/>	white		50 cm	4,95 €	new
---------------	--------------------------	-------	--	-------	---------------	------------







WEIPU HQ SOCKET / PLUG | 2-POLE

940059	■ black	socket with screw cap	12,95 €	new
940060	■ black	plug	12,95 €	new
940058	■ black	socket special structural shape	12,95 €	new



WEIPU HQ SOCKET / PLUG | 4-POLE

940063	■ black	socket with screw cap	13,95 €	new
940062	■ black	plug	13,95 €	new
940061	■ black	socket special structural shape	13,95 €	new



WEIPU HQ SOCKET / PLUG | 5-POLE

940056	■ black	socket with screw cap	14,95 €	new
940057	■ black	plug	14,95 €	new



WEIPU CABLE

When planning and installing low-voltage DC systems, always pay attention to the cable lengths. A total length of 10 metres must not be exceeded. Excessive lengths can lead to voltage losses within the cables, e.g. to different colour renditions of RGB spotlights or visible brightness differences. Malfunctions such as flashing, flickering or flashing of the lamps can also occur. Furthermore, each radiator should be supplied with a separate connection cable if possible. Avoid installations with more than 3 radiators within one cable harness.

WEIPU HQ

Our new Weipu HQ cable series provides the highest quality cables and connectors, as well as higher cable cross-sections for even more reliability and durability for the power supply and operation of the corresponding spotlights.

WEIPU HQ SUPPLY CABLE | SOCKET 2-POLE

940037	■ black	1m	20,95 €	new
940038	■ black	3m	27,95 €	new
940039	■ black	5m	34,95 €	new



WEIPU HQ SUPPLY CABLE | SOCKET 4-POLE

940033	■ black	1m	25,95 €	new
940034	■ black	3m	39,95 €	new
940035	■ black	5m	52,95 €	new



WEIPU HQ SUPPLY CABLE | SOCKET | 5-POLE

940029	■ black	1m	29,95 €	new
940030	■ black	3m	44,95 €	new
940031	■ black	5m	56,95 €	new



WEIPU HQ CONNECTION CABLE | 2-POLE

940049	■ black	1m	32,95 €	new
940050	■ black	3m	39,95 €	new
940051	■ black	5m	46,95 €	new



WEIPU HQ CONNECTION CABLE | 4-POLE

940045	■ black	1m	39,95 €	new
940046	■ black	3m	52,95 €	new
940047	■ black	5m	64,95 €	new



WEIPU HQ CONNECTION CABLE | 5-POLE

940041	■ black	1m	44,95 €	new
940042	■ black	3m	56,95 €	new
940043	■ black	5m	68,95 €	new



WEIPU JUNCTION BOX

- 2 outgoing plug sockets
- dimensions L x W x H: 57 x 57 x 38 mm

730300	■ black	2-pole 30 cm connection cable	56,95 €
730301	■ black	4-pole 30 cm connection cable	62,95 €
940010	■ black	5-pole 100 cm connection cable	69,95 €



DMX CONNECTION CABLE

- XLR-cable
- 3-pole plug / socket

819066	■ black	1 m	19,95 €
819067	■ black	2 m	22,95 €
819070	■ black	5 m	24,95 €
819072	■ black	10 m	29,95 €
819071	■ black	20 m	39,95 €



DMX CONNECTION CABLE OUTDOOR

- XLR-cable
- 3-pole plug / socket

180704	■ black	2 m	11,95 €
180705	■ black	5 m	21,95 €
180706	■ black	10 m	38,95 €



DMX CABLE ADAPTER | CAT5 TO DMX XLR

882271	DMX-plug to CAT5	49,95 €
882272	DMX-socket to CAT5	49,95 €



illustr. shows DMX-plug

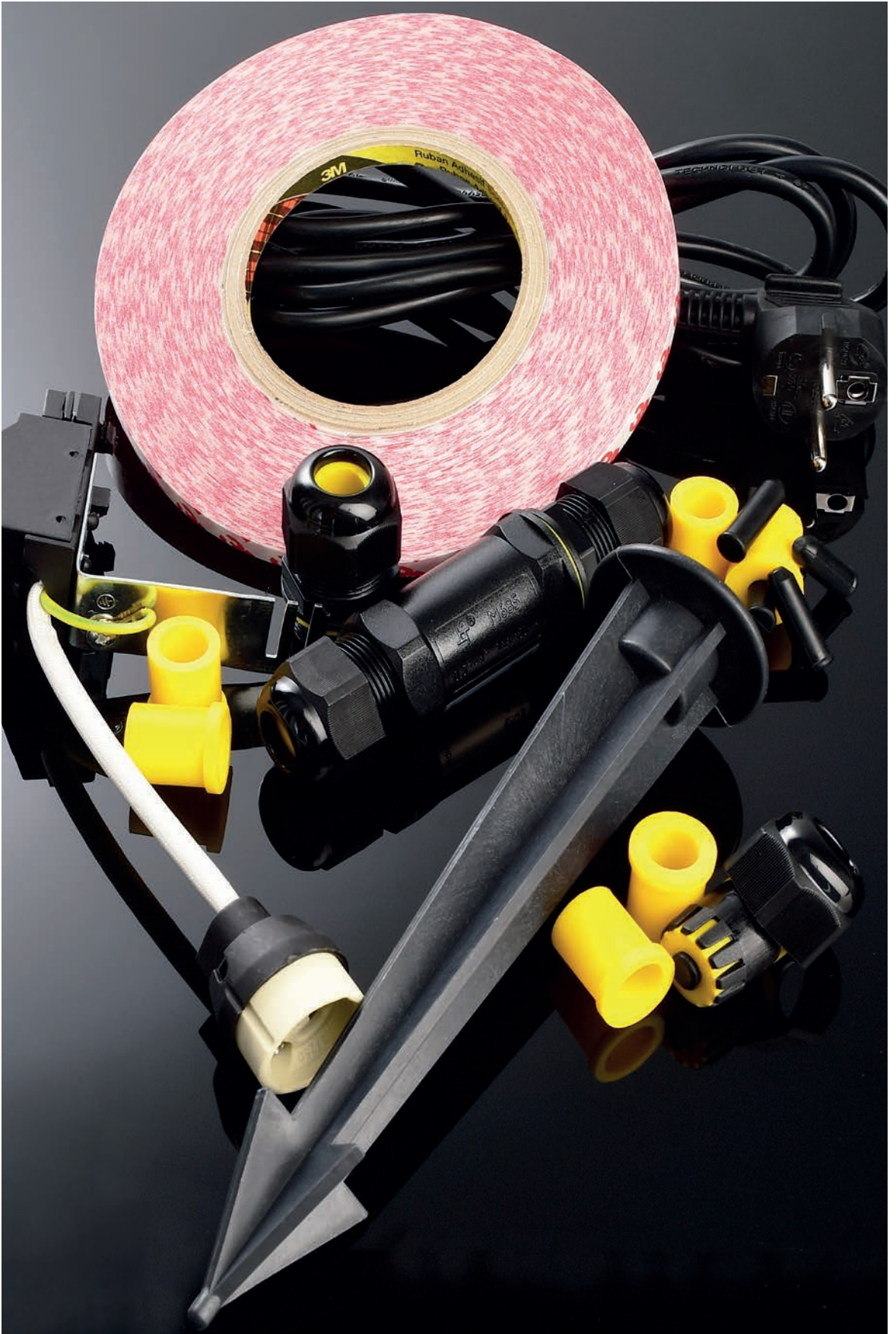

CERAMIC CLAMPS

- 2-pole, mit with fixing hole
- cable bis max. 2,5mm²
- dimensions L x W x H: 21 x 18 x 10 mm

100301 white **0,95 €**



GU10 SOCKET

- ceramics
- 15 cm cable

100202 white **2,95 €**



GU10 SOCKET

- spacer combined with junction box
- separate connection for protective conductor
- 10 cm cable

Essential: screw fitting mandatory for using with assembling frame between spacer VDE.

100204 white **3,95 €**



CONNECTION CABLE WITH 230V MAINS PLUG

- plastic
- mains plug IP44
- cable H07RN-F, 3x 1,5mm²
- open cable ends

930587 black Länge 2950 mm **19,95 €** **new**



WIELAND GST18i3 PLUG | SOCKET | DISTRIBUTOR BLOCK

• high voltage, 3-pole, wire cross section 0,75 - 2,5 mm²

800105	■ black	plug	6,95 €
800100	■ black	socket	6,95 €
800115	■ black	distributor block 1 input 5 outputs	21,95 €

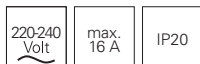

WIELAND GST18i3 SUPPLY CABLE WITH SCHUKO PLUG

• high voltage, 3-pole, wire cross section 3 x 1,5 mm²

800116	■ black	200 cm	16,95 €	new
---------------	---------	--------	----------------	------------



WIELAND GST18i3 SUPPLY CABLE WITH SOCKET | PLUG

• high voltage, 3-pole, wire cross section 3 x 1,5 mm²

800109	■ black	socket 100 cm	8,95 €
800111	■ black	socket 300 cm	12,95 €
800112	■ black	plug 100 cm	8,95 €
800114	■ black	plug 300 cm	12,95 €

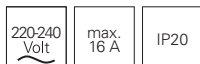

WIELAND GST18i3 EXTENSION CABLE

• high voltage, 3-pole, wire cross section 3 x 1,5 mm²

800106	■ black	100 cm	13,95 €
800107	■ black	200 cm	14,95 €
800108	■ black	300 cm	17,95 €

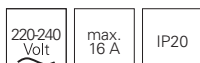

WIELAND RST20i3 PLUG | SOCKET DISTRIBUTOR BLOCK | PROTECTIVE CAP

- high voltage, 3-pole
- wire cross section 1,5 mm² - 4,0 mm²

800024	■ black	plug	12,95 €
800023	■ black	socket	12,95 €
800025	■ black	distributor 1 input 3 outputs	19,95 €
800026	■ black	protective cap for plug	2,95 €
800027	■ black	protective cap for socket	2,95 €

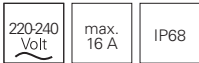

WIELAND RST120i3 SUPPLY CABLE WITH SCHUKO PLUG

- high voltage, 3-pole, wire cross section 3 x 1,5 mm²

800028	■ black	400 cm	58,95 €	new
---------------	---------	--------	----------------	------------



WIELAND RST20i3 SUPPLY CABLE

- high voltage, 3-pole
- with socket and open end
- cable type H07RN-F3
- G1/5 1,5 mm²

800033	■ black	200 cm	23,95 €
---------------	---------	--------	----------------



WIELAND RST20i3 CONNECTION CABLE SOCKET | PLUG

- high voltage, 3-pole
- Leitung H07RN-F3
- G1/5 1,5 mm²

800029	■ black	200 cm	27,95 €
800036	■ black	400 cm	38,95 €



MULTI OUTDOOR CABLE DISTRIBUTORS

The more luminaires and accompanying lighting solutions are planned and project, the more complex the cable management becomes. A wide variety of cable and wire cross-sections come together and have to be connected as efficiently as possible. In outdoor areas, there are requirements added to protect cables against external influences. With the new, multifunctional cable connectors and distributors, you are perfectly equipped for these tasks.

All multi-outdoor cable distributors are supplied with the appropriate adapter sleeves in order to be able to insert different cable cross-sections, depending on the model.

waterproof cable glands

supplied blind plugs for unused cable entries
cable entries

access to cables via screwed, waterproof cover
cover



OUTDOOR CABLE CONNECTORS GELBOX IPX8

- set consisting of 2 gel boxes
- silicone
- dimensions L x W x H: 38 x 30 x 26 mm
- 3 x 2,5mm² / 5 x 2,5mm²

930402  colourless

26,95 €



IP68

MULTI OUTDOOR CABLE CONNECTORS | CONNECTION SLEEVE

- waterproof cable glands M25
- for 2 cable 4-14 mm [adapter grommets included]
- for 2-5 wires 0,5-4 mm²
- L x W x H: 112,53 x 29,50 x 32,56 mm
- observe installation instructions

930571  black/yellow

15,95 € **new**

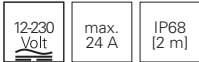

MULTI OUTDOOR Y-CABLE CONNECTORS | CONNECTION SLEEVE

- waterproof cable glands M25
- for 3 cable 4-14 mm [adapter grommets included]
- for 2-3 wires 0,5-4 mm²
- L x W x H: 139,71 x 71,88 x 32,56 mm
- observe installation instructions

930573  black/yellow

17,95 € **new**

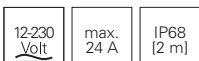

MULTI OUTDOOR CABLE DISTRIBUTOR TYPE 2-FOLD

- waterproof cable glands M20
- for 2 cable 5-12 mm [adapter grommets included]
- for wires 0,5-2,5 mm²
- Ø x H: 65,33 x 46,31 mm
- cover quick screw connection [screwless]
- observe installation instructions

930578 ■ black

9,95 € **new**



12-230 Volt	max. 24 A	IP66
----------------	--------------	------

MULTI OUTDOOR CABLE DISTRIBUTOR TYPE 2-FOLD

- waterproof cable glands M20
- for 2 cable 5-12 mm [adapter grommets included]
- for wires 0,5-2,5 mm²
- L x W x H: 138,20 x 42,77 x 35,70 mm
- cover screwed [screws included in delivery]
- observe installation instructions

930576 ■ black/yellow

11,95 € **new**



12-230 Volt	max. 24 A	IP68 [2 m]
----------------	--------------	---------------

MULTI OUTDOOR CABLE DISTRIBUTOR TYPE 4-FOLD

- waterproof cable glands M25
- for 2-4 cable 4-14 mm [adapter grommets included]
- for wires 0,5-4,0 mm²
- L x W x H: 112,54 x 93,30 x 35,30 mm
- cover screwed [screws included in delivery]
- observe installation instructions

930575 ■ black/yellow

17,95 € **new**



12-230 Volt	max. 24 A	IP68 [2 m]
----------------	--------------	---------------

MULTI OUTDOOR STRAIGHT JOINT CAPSULE 4-FOLD

- spacious socket
- for 2-4 cable 6-14 mm
- for wires bis 2,5 mm²
- Ø x L: 70 x 190 mm
- FDM1: humic acid and corrosion resistant
- quick screw connection [screwless]
- incl. 8 cable ties 150,00 x 2,20 mm
- observe installation instructions



730275  black/yellow

44,95 €

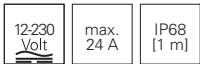

MULTI OUTDOOR CABLE DISTRIBUTOR 10-FOLD

- waterproof cable glands M25
- for 2-10 cable 4-14 mm [adapter grommets included]
- for wires 0,5-4,0 mm²
- L x W x H: 182,95 x 135,30 x 49,10 mm
- cover screwed [screws included in delivery]
- observe installation instructions

930574  black/yellow

39,95 € **new**

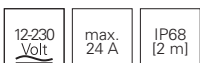



PRESSURE / MOISTURE COMPENSATING VALVE WITH MEMBRAN

- plastic
- minimisation of condensation due to integrated liquid-tight and breathable membrane
- for retrofitting luminaires that are used in warm and humid areas / environments
- pressure rang: P=7Kpa
- incl. plastic flat nut



930583	■ black	M5	380 ml/min.	5 piece set	14,95 €	new
930584	■ black	M8	800 ml/min.	5 piece set	15,95 €	new
930585	□ white	M10	1200 ml/min.	5 piece set	16,95 €	new
930586	□ white	M16	2200 ml/min.	5 piece set	18,95 €	new

IP67

With the kind support of Loxone Lichtinstallation Eurotec.biza@fotoeichhorn



ASSEMBLY SET FOR IP65/IP67 LED STRIPES

- set consisting of:
15 silicone retaining clips
30 stainless steel screws
5 end caps
- delivery without silicone/adhesive

840293	for stripes with 11-12 mm outer dimension	3,95 €
840294	for stripes with 13-15 mm outer dimension	3,95 €
840295	for stripes with 17-19 mm outer dimension	3,95 €

end cap seal		
930104	natural stone sealant	32,95 €



3M™ DOUBLE-SIDED TAPE

- for mounting aluminium profiles or LED strips [not IP65/67 silicone strips] on smooth surfaces

930345	50000 x 08 x 0,20 mm	16,95 €
930346	50000 x 10 x 0,20 mm	17,95 €
930347	50000 x 12 x 0,20 mm	18,95 €
930348	50000 x 15 x 0,20 mm	21,95 €
930349	50000 x 20 x 0,20 mm	28,95 €
930350	50000 x 25 x 0,20 mm	34,95 €

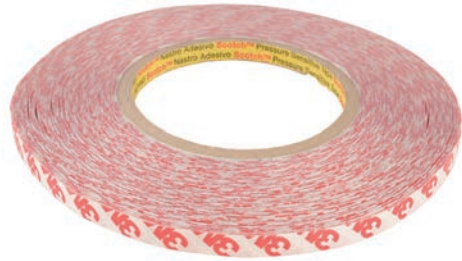

3M™ DOUBLE-SIDED TAPE FOR SILICONE SURFACES

- special adhesive tape for use on LED stripes in silicone hoses and silicone casting
- high solvent resistance
- high temperature resistance
- high initial liability
- high bond strength on most silicone surfaces and hard-to-stick substrate

930405	55000 x 10 x 0,127 mm	139,95 €
930406	55000 x 12 x 0,127 mm	169,95 €



GROUND SPIKE IN CONNECTION WITH INSERT NUT

- plastic / metal
- for ground anchoring of surface-mounted luminaires in the ground

700230	■ black	L x Ø: 200 x 50 mm	M5	4,95 €
930426	■ black	L x Ø: 170 x 40 mm	M5	7,95 €
700229	■ black	L x Ø: 160 x 43 mm	M6	4,95 €
730349	■ black	L x Ø: 210 x 45 mm	M6	6,95 €
930427	■ black	L x Ø: 219 x 45 mm	M10	9,95 €



design example

DISPLAY ARM

- metal
- for mounting surface mounted luminaires at a distance from the object / advertising sign

930007	■ black	55 cm carrying capacity max. 6,5 kg	48,95 €
---------------	---------	--	----------------





GEL ADHESIVE FOR GLUING END CAPS

- cyanoacrylate instant adhesive
- high initial adhesion
- very good adhesion to almost all substrates such as metals, steel, stainless steel, galvanised steel, aluminium, plastics [e.g. ABS, GRP, hard PC] or ceramic materials
- curing time: 8-12 hours
- observe safety and processing instructions



930593 3g, transparent

4,95 € **new**

1010 ACCESSORIES | indoor / outdoor | mounting accessories

MOUNTING GLUE

- highly resilient, elastic 1-component construction adhesive
- very good adhesion on almost all surfaces like e.g. metals, steel, stainless steel, galvanised steel, aluminium, plastics [e.g. ABS, GFK, rigid PVC]. or ceramic materials
- UV-resistant
- approved according to NSF food law [NSF, P1 registered: 136996]
- high initial strength
- overpaintable with all commercial paint systems [except alkyd resin varnishes]

930105 310ml cartridge, white bond+seal power

29,95 €



NATURAL STONE SEALANT

- suitable for gluing profile covers and for use in wet rooms
- does not attack the surface of LEDs/strips
- permanently elastic
- high resistance to weathering, UV, ageing and colour
- suitable for heavy duty use

930104 310ml cartridge, transparent

32,95 €



SEALANT SMOOTHING AGENT

- universally suitable for clean stripping for all types of sealants [e.g. silicones, polyurethane sealants etc.].
- easy processing from the aerosol can
- through uniform cross-linking of the surface the sealant joint hardens faster and the surface is improved

930103 400ml can

32,95 €



DEKO-LIGHT SAMPLE CASE PROFILE

- 45 profiles
- 19 covers
- 4 colour samples
- 2 LED support profiles
- 1 mounting profile

930107 43,6 x 30,6 x 20,5 cm

149,95 €





DEKO-LIGHT SAMPLE CASE LIGHT BASE & ACRUX

Our sample case with LIGHT BASE & ACRUX offers you the possibility to present your customers many variants with little effort. The LIGHT BASE in particular, with its variable cover and small design, is an all-rounder among wall luminaires. It fits into a 68mm switch box. It is preferable to use an electronic box with a bag for the ballast unit. With the exchangeable covers, you and your customers remain flexible right to the end.

However, the ACRUX is in no way inferior to it in this respect. With one lamp you show three variable light colours and, through the removable stainless steel cover, two surfaces. The permanently installed dimmable power supply unit rounds off the package. An investment that is sure to pay for itself quickly.

102040 62,0 x 42,0 x 16,8 cm **price on demand**

- LIGHT BASE COB INDOOR **563000**
cover square - square **930130**
- LIGHT BASE COB INDOOR **563000**
3000 K | 152 lm | 3,20 W
cover square - round **930127**
- LIGHT BASE COB INDOOR **563000**
3000 K | 152 lm | 3,20 W
cover square - trapeze **930360**
- LIGHT BASE COB INDOOR **563000**
3000 K | 152 lm | 3,20 W
cover square - square **930132**
- LIGHT BASE COB INDOOR **563000**
3000 K | 152 lm | 3,20 W
cover square - round **930128**
- LIGHT BASE COB INDOOR **563000** 3000 K | 152 lm | 3,2 W
cover round - trapeze **930357**
- ACRUX 90 **565316** 3000/4000/6000 K | 760 lm | 9 W
- KAPEGO power supply **872027** 700 mA | 4 W | 2-6 V
- DIMMER **930060**
- ACRUX 145 **565318** 3000/4000/6000 K | 1570 lm | 17 W
- ACRUX 120 **565317** 3000/4000/6000 K | 1370 lm | 14,5 W



DEKO-LIGHT SAMPLE CASE RECESSED SPOTLIGHT

With our recessed spotlight sample cases, you can present your customers with a diverse selection from our recessed spotlight range. The different light colours and surfaces are a great help for your customers. In addition, you can show different variants here.

102058 62,0 x 42,0 x 16,8 cm **price on demand**

- COB 68 MOOD **565192** 2000-2800 K | 500 lm | 7 W
cover round **930076**
- LESATH **565261** 2000-2800 K | 500 lm | 8,50 W
frame round **930252**
- LESATH **565261** 2000-2800 K | 500 lm | 8,50 W
frame square **930256**
- COB 68 ACRYL **565195** 2700 K | 675 lm | 6,50 W
ACRYLRING round **930270**
- SATURN **565200** 2700 K | 700 lm | 7,0 W
- COB BACK LIGHT **565224** | 3000 K | 1000 lm | 9 W
- ORIONIS **565239** 2700 K | 645 lm | 6,50 W
- ORIONIS **565242** 2700 K | 645 lm | 6,50 W
- DIMMER **930060**
- COB-68-350MA-round **565278** 2700 K | 580 lm | 6 W
- COB-68-350MA-round **565281** 4000 K | 660 lm | 6 W
- COB-68-350MA-square **565283** 2700 K | 580 lm | 6 W

ELECTRIC CHARACTERISTICS

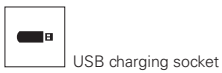
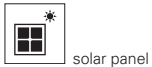
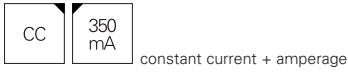
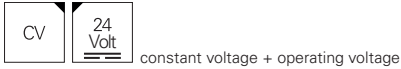
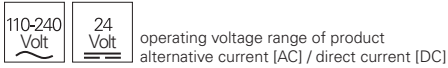

LAMP

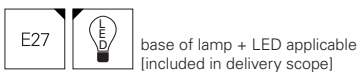
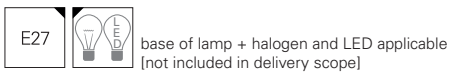
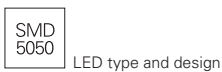
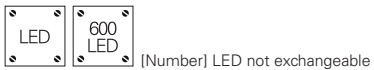
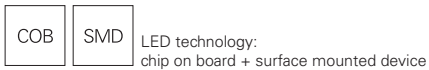

FUNCTIONALITY

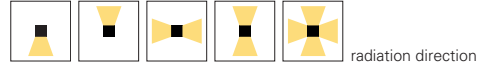
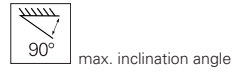
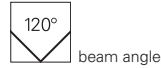

MOUNTING

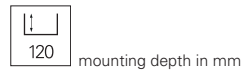
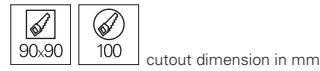

SURFACE

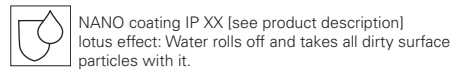

CONTROL



dim to warm function



radio frequency control



Bluetooth control



WiFi control



movement sensor [IR / HF]



DMX control



signal cable



dimmable



number of channels

SAFETY



IP protection class



IK value



walkable



passable



safety lamp control gear



components may be installed on fixtures of materials,
the fire behavior of which is not always known.



max. surface temperature
of lamp control gear



protection class I



protection class II
[protective isolation]



protection class III
[protective low voltage]



no cool beam
In lamps identified as such,
no cold light mirror lamps may be installed.

0	100301	1000	162054.....	980	180187	973
000097	100484.....	986	162055.....	980	180188	973
000099	102040.....	1013	180049.....	652, 969	180512.....	138, 140,
000103.....	102058.....	1013	180050.....	652, 969	144, 146, 148, 149, 153,	
000104.....	110000	124	180051.....	652, 969	476, 478, 488, 492, 917	
000106.....	110001	124	180052.....	652, 969	180513.....	489, 917
000107.....	110002.....	124	180053.....	652, 969	180514.....	141, 493, 917
000109.....	110003.....	125	180054.....	975	180515.....	128, 928
000110.....	110004.....	125	180055.....	975	180529.....	928
000111.....	110006.....	126	180057.....	975	180704.....	413, 998
000140.....	110007.....	126	180058.....	975	180705.....	413, 998
000141.....	110010.....	127	180059.....	975	180706.....	413, 998
000142.....	110011.....	128	180060.....	975		
001247.....	110014.....	129	180061.....	975	2	
001248.....	110015.....	129	180062.....	975	290020	968
001621.....	110016.....	129	180063.....	975	290035	968
050100.....	110017.....	130	180064.....	976	290050	968
050200	110018.....	130	180065.....	976		
050222.....	110019.....	131	180066.....	976	3	
053001.....	110020.....	131	180067.....	976	332266.....	979
071DDL.....	110021.....	131	180068.....	976	332269.....	979
071NDL.....	110022.....	131	180069.....	976	332270.....	979
071WDL.....	110023.....	123	180070.....	976	332271.....	979
	110024.....	123	180071.....	976	341010	189
1	110025.....	123	180080.....	652, 970	341033.....	188
100028.....	110026.....	123	180081.....	652, 970	341035.....	190
100032.....	110100.....	132	180097.....	979	341056.....	193
100035.....	110101	132	180098.....	972	341057.....	191
100043.....	110222.....	121	180099.....	652, 969	341062.....	190
100044.....	110421	133	180109.....	652, 969	341065.....	192
100045.....	110427.....	133	180113.....	652, 969	341105.....	189
100046.....	110500.....	134	180133.....	967	341160.....	170
100047.....	110501	134	180134.....	966	341161	170
100051.....	110503.....	135	180135.....	966	341176	185
100056.....	111821	133	180136.....	977	341177	185
100057.....	120017.....	118	180139.....	969	341178	184
100058.....	120018.....	118	180149.....	969	341180.....	180
100059.....	120020.....	118	180159.....	974	341183.....	178
100069.....	122408.....	135	180163.....	971	341184.....	178
100071.....	122416.....	108	180165.....	972	341185.....	178
100072.....	122417.....	108	180166.....	971	341187.....	184
100073.....	122420.....	136	180167.....	967	341188.....	166
100076.....	126070.....	136	180168.....	967	341189.....	166
100108.....	126073.....	136	180169.....	974	341190.....	166
100109.....	126074.....	136	180173.....	974	341191.....	166
100111.....	131005.....	394	180174.....	967	341192.....	166
100112.....	131006.....	395	180175.....	967	341194.....	168
100114.....	150921.....	931	180176.....	967	341195.....	168
100116.....	151DDL.....	981	180177.....	967	341196.....	168
100133.....	151NDL.....	981	180178.....	970	341197.....	172
100200.....	151WDL.....	981	180179.....	973	341198.....	172
100202.....	162044.....	980	180183.....	967	341200.....	176
100204.....	162046.....	980	180184.....	978	341201.....	176
100238.....	162047.....	980	180185.....	978	341202.....	176
100250.....	162048.....	980	180186.....	972	341203.....	176

341205.....	187	342096.....	66	342172.....	45	348007.....	365
341206.....	187	342097.....	56	342173.....	45	348009.....	365
341207.....	174	342098.....	56	342174.....	45	348011.....	365
341208.....	174	342099.....	58	342175.....	45	348013.....	110
341209.....	175	342101.....	64	342176.....	45	348022.....	108
341210.....	175	342102.....	64	343016.....	556	348023.....	108
341211.....	175	342103.....	64	343017.....	218	348024.....	108
341212.....	175	342104.....	64	343018.....	557	348025.....	108
341214.....	528	342109.....	82	343019.....	559	348040.....	519
341215.....	523	342112.....	74	343020.....	216	348041.....	519
341216.....	164	342113.....	74	343021.....	216	348045.....	361
341217.....	164	342114.....	72	343022.....	561	348046.....	361
341222.....	186	342115.....	72	343023.....	563	348048.....	111
341223.....	191	342116.....	78	343024.....	563	348049.....	111
341224.....	186	342117.....	78	343025.....	210	348051.....	530
341225.....	188	342118.....	76	343026.....	210	348052.....	530
341228.....	206	342119.....	76	343028.....	213	348057.....	519
341229.....	206	342120.....	76	343029.....	213	348058.....	519
341236.....	204	342121.....	76	343031.....	220	348059.....	520
341237.....	204	342122.....	548	346003.....	216	348060.....	520
341242.....	204	342123.....	548	346004.....	216	348062.....	520
341243.....	204	342124.....	548	346009.....	260	348063.....	521
341244.....	310	342125.....	548	346010.....	218	348065.....	521
341245.....	310	342128.....	67	346011.....	258	348066.....	521
341248.....	194	342129.....	47	346012.....	258	348069.....	364
342024.....	67	342130.....	48	346013.....	258	348070.....	364
342025.....	62	342131.....	48	346014.....	258	348071.....	366
342026.....	62	342132.....	47	346015.....	210	348072.....	366
342027.....	63	342133.....	48	346016.....	210	348073.....	100
342028.....	63	342134.....	48	346017.....	212	348074.....	100
342029.....	62	342135.....	47	346018.....	212	348075.....	101
342030.....	62	342136.....	47	346025.....	252	348076.....	102
342031.....	63	342137.....	60	346026.....	215	348077.....	102
342032.....	63	342138.....	60	346027.....	215	348078.....	103
342049.....	52	342142.....	68	346028.....	215	348085.....	104
342050.....	52	342143.....	68	346029.....	215	348086.....	104
342051.....	52	342144.....	70	346030.....	215	348087.....	105
342052.....	52	342145.....	70	346031.....	215	348088.....	106
342053.....	52	342146.....	545	346032.....	252	348089.....	106
342054.....	52	342147.....	545	346033.....	252	348090.....	107
342077.....	553	342148.....	51	346034.....	252	348091.....	106
342078.....	553	342149.....	51	346035.....	252	348092.....	106
342079.....	553	342150.....	51	346036.....	252	348093.....	107
342080.....	553	342151.....	51	346037.....	252	348099.....	529
342081.....	553	342152.....	55	346038.....	256	348103.....	537
342082.....	553	342153.....	55	346039.....	256	348104.....	537
342086.....	80	342154.....	55	346040.....	256	348105.....	537
342087.....	84	342155.....	55	346041.....	254	348106.....	537
342089.....	551	342156.....	55	346042.....	254	348107.....	525
342090.....	551	342157.....	55	346043.....	254	348120.....	363
342091.....	551	342159.....	162	346044.....	220	348121.....	363
342092.....	551	342160.....	162	348001.....	109	348122.....	526
342093.....	551	342169.....	86	348002.....	109	348123.....	526
342094.....	551	342170.....	45	348004.....	109	348124.....	522
342095.....	66	342171.....	45	348005.....	109	348125.....	524

348127.....	527	488352.....	978	565158.....	492	565262.....	152
348128.....	529	48860VW.....	968	565159.....	492	565263.....	152
348129.....	96	48860W.....	968	565160.....	493	565264.....	152
348130.....	96	48865VW.....	968	565161.....	493	565265.....	152
348131.....	96	48865W.....	968	565162.....	493	565278.....	153
348132.....	99	48870VW.....	968	565163.....	493	565279.....	153
348133.....	99			565172.....	144	565280.....	153
348134.....	99	5		565173.....	144	565281.....	153
348135.....	99	501000.....	982	565180.....	476	565282.....	153
348136.....	99	501001.....	982	565181.....	476	565283.....	153
348137.....	99	501002.....	982	565182.....	477	565284.....	153
348138.....	577	501003.....	982	565183.....	477	565285.....	153
348139.....	577	501004.....	982	565184.....	477	565299.....	154
348140.....	610	501008.....	982	565185.....	477	565300.....	154
348141.....	533	501011.....	982	565192.....	157	565301.....	154
348142.....	533	501012.....	982	565193.....	145	565302.....	154
348143.....	533	501013.....	982	565194.....	145	565303.....	154
348144.....	533	501032.....	983	565195.....	146	565304.....	154
348145.....	533	501033.....	983	565196.....	146	565305.....	154
348146.....	533	561201.....	926	565197.....	147	565306.....	154
348147.....	113	561202.....	926	565198.....	145	565307.....	155
348151.....	611	563000.....	201	565200.....	148	565308.....	155
348152.....	610	563006.....	468	565201.....	148	565309.....	155
		563007.....	468	565202.....	148	565310.....	155
4		563008.....	198	565203.....	148	565315.....	481
401003.....	535	565007.....	476	565220.....	497	565316.....	482
401004.....	535	565010.....	476	565221.....	497	565317.....	482
401005.....	534	565067.....	138	565224.....	158	565318.....	483
401006.....	534	565068.....	138	565229.....	478	565320.....	490
401007.....	534	565070.....	138	565230.....	478	565321.....	490
401008.....	534	565071.....	138	565231.....	478	565322.....	491
401009.....	90	565082.....	140	565232.....	478	565323.....	491
401010.....	90	565083.....	140	565233.....	479	565325.....	615
401011.....	582	565084.....	140	565234.....	479	565326.....	614
401012.....	582	565085.....	140	565235.....	479	565327.....	484
401013.....	582	565088.....	140	565236.....	479	565328.....	485
401014.....	582	565089.....	140	565237.....	149	565329.....	485
401015.....	582	565090.....	140	565240.....	149	565332.....	483
401016.....	582	565091.....	140	565241.....	149	565333.....	486
442051.....	118	565094.....	141	565244.....	149	565334.....	486
442052.....	118	565095.....	141	565245.....	150	565335.....	155
442058.....	118	565096.....	141	565246.....	150	565336.....	155
442831.....	121	565097.....	141	565247.....	146	565337.....	156
442832.....	121	565102.....	142	565248.....	151	565338.....	156
442838.....	121	565103.....	142	565249.....	151	565339.....	156
448001.....	137	565108.....	144	565250.....	470	565342.....	489
449200.....	120	565109.....	144	565251.....	470	565343.....	488
449201.....	120	565110.....	144	565252.....	471	565344.....	489
449202.....	120	565111.....	144	565253.....	472		
449210.....	122	565152.....	492	565254.....	472	6	
449211.....	122	565153.....	492	565255.....	473	620006.....	229
449212.....	122	565154.....	492	565256.....	474	620007.....	229
46860W.....	968	565155.....	492	565257.....	474	620008.....	226
46865W.....	968	565156.....	492	565258.....	475	620009.....	226
484322.....	978	565157.....	492	565261.....	159	620010.....	227

620011	227	620119	648	688003	236	707042	663
620012	230	620120	648	688008	599	707043	663
620013	230	620121	547	688019	598	707044	668
620014	231	620122	547	688020	598	707045	650
620015	231	620123	323	688021	598	707046	650
620016	232	620124	323	688024	598	707047	650
620017	232	620125	323	688025	241	707048	650
620018	233	620126	323	688026	241	707050	651
620019	233	620127	323	688027	241	707053	651
620020	234	620128	323	688028	241	707054	662
620021	235	620129	323	688029	242	707055	662
620031	604	620130	323	688030	242	707056	663
620032	604	620132	182	688031	242	707057	663
620033	93	620133	182	688033	242	707058	647
620034	93	620134	182	688034	242	707059	647
620035	93	620135	182	688035	242	707060	647
620036	93	620136	178	688036	242	707061	661
620037	93	620137	178	688037	242	707062	661
620038	93	620138	178	688038	244	707067	665
620039	93	620139	178	688039	244	707068	665
620040	93	620140	178	688040	244	707069	664
620041	94	666662	978	688041	244	707070	664
620042	94	666663	978	688042	244	707071	649
620043	94	666664	978	688043	244	707072	649
620044	94	686864	120	688044	244	707073	649
620045	94	686867	120	688045	244	707074	649
620046	94	686868	120			707075	649
620047	94	686869	120	7		707076	649
620048	94	686871	120	700229	1009	707079	652
620049	95	686880	120	700230	1009	707080	652
620050	95	686940	236	707015	650	707081	652
620051	95	687034	230	707017	647	707082	667
620052	95	687035	231	707018	659	707083	667
620053	95	687039	227	707019	659	707084	651
620054	95	687059	226	707020	660	707085	651
620055	95	687062	224	707021	660	707087	651
620056	95	687063	235	707022	658	707088	651
620057	541	687064	224	707023	658	707090	653
620102	541	687065	234	707024	658	707091	653
620103	541	687070	224	707025	658	707092	653
620104	543	687071	224	707026	659	707093	653
620105	541	687072	224	707027	659	707094	654
620106	541	687073	224	707028	660	707095	654
620107	541	687074	225	707029	660	707096	654
620108	541	687075	225	707030	666	707097	654
620109	541	687076	225	707031	666	707098	655
620110	541	687077	225	707032	666	707099	655
620111	543	687078	225	707033	666	707100	655
620112	543	687079	225	707034	650	707101	655
620113	543	687095	237	707036	662	707102	656
620114	543	687096	228	707037	662	707103	656
620115	543	687117	224	707038	662	707104	656
620116	543	687118	224	707039	662	707105	656
620117	543	687130	232	707040	663	707106	657
620118	543	687131	233	707041	663	707107	657

707108.....	657	710054.....	642	730263.....	448	730469.....	425
707109.....	657	710055.....	642	730266.....	435	730470.....	423
710000.....	625	710056.....	642	730267.....	435	730474.....	420
710001.....	625	710057.....	634	730275.....	1006	730475.....	421
710002.....	625	710058.....	634	730276.....	438	730476.....	420
710003.....	625	710059.....	634	730289.....	432	730477.....	421
710004.....	625	710060.....	643	730292.....	444	730478.....	420
710005.....	625	710061.....	643	730296.....	432	730479.....	421
710006.....	625	710062.....	643	730300.....	997	731005.....	303
710007.....	625	710063.....	634	730301.....	997	731006.....	304
710008.....	625	710064.....	634	730328.....	328	731007.....	304
710009.....	627	710065.....	634	730329.....	328	731008.....	303
710010.....	627	710066.....	633	730330.....	314	731009.....	303
710011.....	627	710067.....	633	730331.....	314	731010.....	305
710012.....	627	710068.....	633	730332.....	279	731011.....	305
710013.....	627	710069.....	625	730333.....	279	731012.....	306
710014.....	627	710070.....	625	730336.....	427	731014.....	321
710015.....	629	710071.....	625	730339.....	422	731015.....	330
710016.....	629	710077.....	633	730340.....	422	731016.....	345
710017.....	629	710078.....	635	730349.....	1009	731019.....	330
710018.....	629	710079.....	633	730354.....	290	731020.....	330
710019.....	629	710081.....	636	730355.....	334	731021.....	348
710020.....	629	710082.....	637	730364.....	287	731024.....	330
710021.....	640	710083.....	637	730365.....	287	731025.....	330
710022.....	640	710084.....	635	730366.....	347	731026.....	330
710023.....	640	710085.....	635	730380.....	328	731029.....	329
710024.....	642	710086.....	635	730381.....	338	731030.....	329
710026.....	642	710087.....	635	730382.....	338	731031.....	346
710027.....	631	710088.....	635	730395.....	345	731032.....	354
710028.....	631	710089.....	627	730407.....	360	731033.....	354
710029.....	631	710090.....	628	730408.....	360	731052.....	362
710030.....	631	710091.....	630	730409.....	361	731053.....	362
710031.....	631	710092.....	632	730410.....	361	731054.....	344
710032.....	631	710093.....	631	730419.....	579	731055.....	344
710033.....	632	710094.....	636	730420.....	434	731059.....	308
710034.....	632	710095.....	636	730421.....	434	731060.....	315
710035.....	632	710096.....	636	730424.....	579	731068.....	343
710036.....	630	730007.....	273	730425.....	579	731071.....	348
710037.....	630	730008.....	445	730432.....	446	731072.....	349
710038.....	630	730009.....	275	730434.....	446	731079.....	353
710039.....	628	730014.....	308	730436.....	449	731080.....	350
710040.....	628	730032.....	273	730437.....	448	731082.....	350
710041.....	628	730034.....	306	730438.....	425	731083.....	347
710042.....	628	730134.....	458	730439.....	425	731087.....	334
710043.....	628	730179.....	409	730440.....	413	731088.....	334
710044.....	628	730199.....	437	730447.....	424	731091.....	325
710045.....	626	730209.....	436	730449.....	439	731098.....	396
710046.....	626	730211.....	430	730450.....	580	731099.....	332
710047.....	626	730238.....	395	730454.....	439	731100.....	332
710048.....	636	730244.....	438	730455.....	581	731101.....	321
710049.....	636	730248.....	436	730459.....	426	731102.....	327
710050.....	636	730249.....	431	730464.....	588	731103.....	317
710051.....	639	730250.....	431	730465.....	588	731104.....	602
710052.....	639	730255.....	429	730466.....	589	731105.....	603
710053.....	639	730262.....	445	730468.....	425	731107.....	302

731109.....	326	732084.....	572	733036.....	292	800106.....	1001
731110.....	342	732085.....	573	733037.....	291	800107.....	1001
731112.....	352	732093.....	396	733038.....	291	800108.....	1001
731113.....	318	732094.....	397	733039.....	291	800109.....	1001
731115.....	342	732095.....	397	733040.....	280	800111.....	1001
731116.....	266	732096.....	592	733041.....	280	800112.....	1001
731117.....	320	732097.....	593	733042.....	280	800114.....	1001
731118.....	355	732098.....	594	733043.....	284	800115.....	1001
731119.....	325	732099.....	592	733044.....	284	800116.....	1001
731122.....	262	732100.....	593	733045.....	284	819066.....	998
731124.....	356	732101.....	594	733046.....	266	819067.....	998
731127.....	337	732102.....	595	733047.....	286	819070.....	998
731128.....	337	732103.....	595	733048.....	286	819071.....	998
731129.....	335	732104.....	399	733049.....	265	819072.....	998
731130.....	312	732105.....	590	733050.....	265	829063.....	989
731131.....	312	732106.....	591	733051.....	268	836011.....	380
731132.....	351	732107.....	591	733052.....	282	836012.....	380
731134.....	335	732108.....	399	733053.....	282	836013.....	381
731135.....	335	732109.....	400	733054.....	388	836014.....	380
731136.....	335	732110.....	401	733055.....	388	836015.....	380
731137.....	309	732123.....	402	733056.....	294, 392	836016.....	381
731138.....	341	732124.....	403	733057.....	297	836018.....	384
731139.....	341	732125.....	403	733058.....	297	836019.....	384
731140.....	341	732126.....	393	733059.....	392	836020.....	385
731141.....	341	732127.....	402	733060.....	392	836930.....	380
731142.....	612	732128.....	403	733061.....	277	836931.....	380
731143.....	613	732129.....	403	740005.....	454	836934.....	380
732012.....	587	732134.....	402	740006.....	456	836935.....	380
732013.....	587	732136.....	401	740007.....	452	836958.....	380
732014.....	406	732137.....	404	740008.....	455	836960.....	380
732016.....	406	732138.....	566	740009.....	457	836961.....	381
732019.....	412	732139.....	568	763004.....	372	836962.....	381
732022.....	412	732140.....	568	763005.....	372	836963.....	381
732025.....	587	732141.....	569	763006.....	372	840097.....	847
732026.....	587	732142.....	569	763007.....	372	840122.....	840
732027.....	586	732143.....	440	763011.....	372	840124.....	840
732028.....	586	733002.....	274	763012.....	372	840142.....	847
732029.....	586	733003.....	274	763025.....	374	840144.....	857
732030.....	587	733004.....	288	763026.....	376	840147.....	854
732031.....	587	733005.....	289	785016.....	453	840158.....	837
732036.....	394	733006.....	289	785017.....	453	840159.....	837
732037.....	395	733007.....	290			840164.....	833
732041.....	592	733008.....	289	8		840165.....	833
732045.....	594	733012.....	272	800023.....	1002	840166.....	833
732049.....	440	733017.....	383	800024.....	1002	840167.....	833
732050.....	441	733018.....	279	800025.....	1002	840170.....	833
732064.....	590	733025.....	288	800026.....	1002	840172.....	834
732071.....	414	733026.....	288	800027.....	1002	840175.....	838
732072.....	415	733027.....	382	800028.....	1002	840178.....	838
732074.....	408	733028.....	272	800029.....	1002	840179.....	838
732075.....	408	733031.....	292	800030.....	931	840180.....	838
732076.....	409	733032.....	382	800033.....	1002	840186.....	841
732079.....	414	733033.....	286	800036.....	1002	840187.....	841
732080.....	415	733034.....	286	800100.....	1001	840192.....	839
732083.....	571	733035.....	286	800105.....	1001	840193.....	839

840194.....	839	840340.....	844	843043.....	987	862049.....	468, 470, 472, 474, 916
840210.....	838	840343.....	844	843044.....	988	862050.....	916
840236.....	857	840344.....	843	843045.....	989	862051.....	226, 227, 228, 230, 231, 232, 233, 234, 235, 236, 904
840239.....	859	840345.....	844	843046.....	957	862052.....	904
840254.....	853	840346.....	843	843047.....	956	862053.....	904
840256.....	855	840347.....	850	843049.....	945	862054.....	904
840267.....	838	840348.....	849	843050.....	945	862057.....	921
840276.....	853	840349.....	850	843051.....	962	862074.....	224, 225
840283.....	876	840350.....	849	843052.....	962	862091.....	904
840284.....	879	840351.....	855	843053.....	604, 941	862092.....	904
840285.....	867	840352.....	854	843054.....	961	862093.....	900
840286.....	871	840353.....	858	843055.....	989	862094.....	900
840287.....	877	840354.....	858	843056.....	154, 155, 412, 422, 423, 424, 425, 429, 432, 445, 452, 453, 454, 456, 458, 946	862121.....	894, 900
840288.....	869	840356.....	858	843057.....	142, 145, 146, 506, 509, 946	862122.....	154, 155, 506, 900
840289.....	873	840357.....	859	843058.....	147, 428, 438, 439, 448, 449, 453, 455, 457, 947	862123.....	900
840290.....	881	840358.....	861	843059.....	150, 151, 155, 414, 415, 439, 507, 510, 511, 604, 947	862124.....	900
840291.....	837	840359.....	860	843060.....	960	862125.....	900
840293.....	1008	840360.....	860	843061.....	943	862126.....	142, 900, 907
840294.....	1008	840362.....	776	843064.....	946, 948	862127.....	901
840295.....	1008	840363.....	780	843065.....	946, 948	862128.....	915
840296.....	826	840364.....	782	843066.....	947, 949	862129.....	915
840297.....	863	840365.....	786	843067.....	947, 949	862130.....	916
840298.....	863	840366.....	776	843268.....	958	862131.....	916
840299.....	865	840367.....	780	843269.....	604, 958	862132.....	916
840300.....	865	840368.....	782	843273.....	960	862133.....	917
840304.....	826	840369.....	786	843274.....	911, 961	862134.....	917
840308.....	858	840370.....	778	843275.....	911, 961	862135.....	471, 473, 475, 917
840309.....	858	840371.....	784	843277.....	908	862136.....	920
840310.....	883	840372.....	788	843278.....	908	862138.....	920
840311.....	883	840373.....	859	843335.....	959	862141.....	921
840312.....	883	840374.....	829	843336.....	959	862142.....	920
840313.....	883	840375.....	831	843337.....	959	862154.....	920
840317.....	844	840376.....	875	847015.....	805	862157.....	917
840318.....	843	840377.....	878	847016.....	805	862160.....	907, 908
840319.....	844	843000.....	604, 954	847017.....	805	862161.....	907, 908
840320.....	843	843001.....	953	847018.....	805	862162.....	235, 901
840321.....	827	843003.....	954	861203.....	955	862163.....	901
840322.....	827	843004.....	952	862012.....	924	862164.....	414, 415, 507, 510, 511, 604, 901
840323.....	826	843005.....	952	862013.....	924	862165.....	901
840324.....	826	843007.....	939	862014.....	924	862166.....	142, 145, 146, 147, 150, 151, 154, 155, 506, 509, 901
840325.....	839	843008.....	944	862030.....	489, 919	862167.....	901
840326.....	839	843010.....	604, 963	862031.....	919	862168.....	145, 507, 510, 511, 901
840327.....	825	843011.....	944	862032.....	468, 470, 472, 474, 919	862172.....	900
840328.....	825	843013.....	946, 947	862037.....	224, 225	862173.....	900
840329.....	825	843014.....	946	862038.....	224, 225	862174.....	925
840330.....	825	843015.....	946	862048.....	916	862175.....	925
840331.....	840	843016.....	947				
840332.....	840	843017.....	947				
840333.....	841	843018.....	946, 948				
840334.....	841	843019.....	946, 948				
840335.....	839	843020.....	947, 949				
840336.....	839	843021.....	947, 949				
840337.....	843	843033.....	987				
840338.....	844	843037.....	945				
840339.....	843	843042.....	987				

862176.....	925	872083.....	403, 404, 409,	872634.....	916	747, 749, 751, 753, 755,	
862180.....	641	412, 422, 423, 424, 425,		872635.....	232, 233, 234,	757, 759, 765, 767, 771	
862181.....	641	428, 429, 432, 438, 439,			235, 236, 894, 900	930127.....	201
862182.....	641	445, 448, 901		872636.....	142, 145, 150,	930128.....	201
862183.....	641	872084.....	901		151, 154, 155, 412, 900	930129.....	201
862184.....	641	872085.....	414, 415, 449,	872641.....	917	930130.....	201
862185.....	641		901	872642.....	148, 149	930131.....	201
862187.....	928	872086.....	901	872643.....	138, 140, 920	930132.....	201
862188.....	928	872087.....	901	872646.....	152	930152.....	499, 504, 510,
862189.....	928	872088.....	901	872647.....	920		511, 513
862190.....	140, 141, 478,	872089.....	509, 901	872665.....	476, 917	930153.....	512
	489, 492, 923	872091.....	901	872817.....	906	930160.....	224
862191.....	468, 470, 472,	872093.....	901	872818.....	916	930167.....	497, 512
	474, 476, 478, 479, 488,	872094.....	449, 901	872826.....	916	930168.....	502, 512
	492, 493, 923	872095.....	904	882271.....	956, 957, 998	930179.....	498, 500, 501,
862192.....	471, 473, 475,	872096.....	904	882272.....	998		506, 507, 513
	477, 479, 486, 489, 497,	872097.....	902			930180.....	505, 513
	500, 501, 502, 504, 923	872098.....	902	9		930188.....	658
862193.....	477, 923	872099.....	902	920131.....	207	930189.....	658
862194.....	505, 923	872100.....	902	920132.....	988	930191.....	224
862198.....	468, 470,	872101.....	902	930001.....	991	930194.....	348, 349
	472, 474, 477, 479, 489,	872102.....	902	930006.....	991	930196.....	519, 659
	497, 917	872103.....	902	930007.....	1009, 588	930206.....	520, 521, 660
862201.....	477, 500, 501,	872104.....	902	930036.....	988	930207.....	520, 521, 660
	502, 504, 917	872105.....	902	930060.....	986	930209.....	224
862202.....	140, 144, 146,	872106.....	902	930071.....	579, 580, 581	930210.....	519, 659
	148, 149, 152, 153, 478,	872107.....	902	930072.....	579, 580, 581	930211.....	519, 659
	492, 920	872108.....	902	930074.....	128, 157	930212.....	224
862204.....	476, 478, 488,	872109.....	910	930075.....	128, 157	930213.....	224
	492, 920	872110.....	910	930076.....	128, 157	930214.....	224, 225
862205.....	476, 920	872112.....	910	930077.....	128, 157	930215.....	470, 472, 474,
862207.....	141, 468, 470,	872113.....	910	930078.....	128, 157		528
	472, 474, 479, 493, 920	872116.....	902	930079.....	128, 157	930216.....	470, 472, 474
862208.....	471, 473, 475,	872117.....	907	930089.....	487	930217.....	471, 473, 475
	477, 479, 489, 497, 920	872118.....	909	930090.....	487	930218.....	470, 472, 474,
862209.....	477, 500, 501,	872119.....	902	930091.....	487		528
	502, 504, 920	872120.....	907	930092.....	487	930219.....	470, 472, 474
862211.....	505, 920	872121.....	909	930093.....	487	930220.....	471, 473, 475
862212.....	915	872122.....	902	930094.....	487	930230.....	497, 514
872011.....	906	872123.....	907	930095.....	487	930231.....	502, 514
872013.....	919	872124.....	909	930096.....	487	930232.....	498, 500, 501,
872014.....	919	872125.....	902	930097.....	487		506, 507, 514
872015.....	201, 919	872127.....	236, 899	930099.....	128, 157	930233.....	499, 504, 510,
872026.....	915	872128.....	899, 952, 953,	930100.....	128, 157		511, 515
872027.....	201, 915		954, 955	930103.....	1011, 793, 795,	930234.....	505, 515
872040.....	899	872628.....	144, 916		797, 799, 801	930239.....	519, 659
872041.....	394, 395, 402,	872629.....	232, 233, 894,	930104.....	1008, 1011,	930242.....	224, 225
	422, 423, 424, 425, 429,		900		793, 795, 797, 799, 801	930243.....	224
	899	872630.....	154, 900	930105.....		930244.....	225
872045.....	452, 453, 454,	872631.....	478, 492, 916		1011, 741, 743, 745, 747,	930245.....	225
	455, 456, 457, 458, 905	872632.....	234, 236, 894,		749, 751, 753, 755, 757,	930246.....	225
872046.....	453, 454, 455,		900		759, 763, 765, 767, 769	930247.....	225
	456, 457, 458, 905	872633.....	142, 145, 146,	930107.....	1012	930248.....	225
872065.....	915		147, 151, 154, 155, 412,	930111.....	725, 735,	930249.....	225
872082.....	901		900		737, 739, 741, 743, 745,	930250.....	225

930251.....	225	930342.....	512	401, 403, 404	930502.....	199	
930252.....	159	930345.....	1008, 701, 713	930428.....	399	930503.....	199
930253.....	159	930346.....	1008	930430.....	399	930504.....	199
930254.....	159	930347.....	1008, 703, 715	930431.....	399	930505.....	199
930255.....	159	930348.....		930432.....	399	930512.....	838
930256.....	159		1008, 705, 707, 717, 719,	930434.....	400	930513.....	838
930257.....	159		745, 753, 755, 757, 765	930435.....	400	930514.....	839
930270.....	146, 147	930349.....	1008, 709,	930437.....	401	930515.....	839
930271.....	146, 147		721, 767	930438.....	401	930516.....	854
930293.....	571, 572, 573	930350.....	1008, 711, 741,	930441.....	399, 402, 403	930517.....	857
930295.....	571, 572, 573		743, 747, 749, 751	930442.....	400, 401, 403	930530.....	875, 876, 878,
930297.....	662	930357.....	201	930443.....	875, 876, 878,		879
930298.....	662	930358.....	201		879	930531.....	867, 871
930299.....	662	930359.....	201	930444.....	875, 876, 878,	930532.....	877, 881
930300.....	662	930360.....	201		879	930533.....	869, 873
930301.....	652, 662	930361.....	201	930445.....	867, 871	930544.....	529, 547, 648
930302.....	652, 662	930362.....	201	930446.....	867, 871	930545.....	529, 547, 648
930303.....	652, 662	930363.....	663	930447.....	877, 881	930546.....	529, 547, 648
930306.....	488, 523, 525,	930364.....	662	930448.....	869, 873	930558.....	404
	662, 668	930365.....	663	930449.....	869, 873	930560.....	883
930307.....	488, 523, 525,	930366.....	652, 662	930451.....	877, 881	930561.....	883
	662, 668	930371.....	488, 523, 525,	930461.....	377	930563.....	883
	662, 668		668	930468.....	377	930564.....	883
930308.....	488, 523, 525,	930381.....	489, 526	930469.....	377	930567.....	401
	662, 668	930382.....	489, 527	930470.....	377	930568.....	401
930309.....	488, 523, 525,	930386.....	649	930471.....	377	930569.....	401
	662, 668	930387.....	649	930472.....	377	930571.....	1004
930310.....	488, 523, 525,	930388.....	649	930473.....	377	930573.....	1004
	662, 668	930390.....	489, 527	930474.....	377	930574.....	1006
930311.....	663	930392.....	489, 527	930475.....	377	930575.....	1005
930312.....	663	930394.....	527	930476.....	377	930576.....	1005
930313.....	663	930396.....	489, 527	930477.....	377	930577.....	529, 547, 648
930314.....	663	930398.....	489, 527	930478.....	377	930578.....	1005
930315.....	663	930399.....	489, 527	930480.....	198	930583.....	1007
930316.....	663	930402.....	1004	930481.....	199	930584.....	1007
930317.....	663	930405.....	1008	930482.....	198	930585.....	1007
930318.....	663	930406.....	1008	930483.....	198	930586.....	1007
930320.....	663	930411.....	592, 593, 594,	930484.....	198	930587.....	1000
930321.....	663		595	930485.....	198	930588.....	509, 510, 511
930322.....	663	930412.....	924	930486.....	198	930590.....	566, 568, 569
930323.....	663	930413.....	375	930487.....	198	930592.....	241, 242, 244
930324.....	663	930414.....	375	930488.....	198	930593.....	1010, 867,
930327.....	526	930415.....	375	930489.....	198		869, 871, 873, 875, 876,
930329.....	489, 526	930416.....	375	930490.....	198		877, 878, 879, 881, 883
930331.....	489, 526	930417.....	375	930491.....	198	930594.....	241, 242, 244
930332.....	489, 526	930418.....	375	930492.....	198	930611.....	252
930333.....	489, 526	930419.....	375	930493.....	198	930612.....	252
930335.....	523, 525, 668	930420.....	375	930494.....	199	930613.....	252
930337.....	488, 523, 525,	930421.....	375	930495.....	199	930614.....	252
	668	930422.....	375	930496.....	199	930615.....	252
930339.....	488, 523, 525,	930423.....	375	930497.....	199	930616.....	252
	668	930424.....	375	930498.....	199	930617.....	252
930340.....	488, 523, 525,	930426.....	1009, 399,	930499.....	199	930618.....	253
	668		402, 403	930500.....	199	930619.....	253
930341.....	488, 523, 525,	930427.....	1009, 400,	930501.....	199	930620.....	253
	668						

930621.....	253	970047	706	970181	700	970520.....	736
930622.....	253	970048	706	970182	700	970522.....	736
930623.....	253	970060	708	970183.....	700	970523.....	736
930624.....	253	970061	708	970184.....	700	970524.....	736
930625.....	253	970062	708	970185.....	700	970550.....	746
930626.....	253	970063	708	970186.....	700	970551.....	746
930627.....	253	970064	708	970187.....	700	970560.....	748
930628.....	253	970065	708	970200	710	970561.....	748
930629.....	253	970066	708	970201	710	970570.....	750
930630.....	253	970067	708	970202.....	710	970571.....	750
930631.....	253	970068	708	970205.....	710	970600	738
930632.....	.610, 611	970080	700	970230.....	726	970601	738
930633.....	.610, 611	970081	700	970231.....	726	970602.....	738
930634.....	.610, 611	970082	700	970260.....	724	970720.....	792
930641.....	566, 568, 569	970083	700	970261.....	724	970721.....	792
930642.....	568, 569	970084	700	970262.....	724	970722.....	792
930647.....	90	970085	700	970280.....	730	970723.....	792
940010.....	997	970086	700	970281.....	730	970724.....	792
940032	993	970100.....	702	970284.....	730	970725.....	792
940036	993	970101	702	970285.....	730	970740	796
940040	993	970102	702	970286.....	730	970741	796
940044	993	970103	702	970300	752	970762.....	769, 771, 801
940048	993	970104	702	970301	752	970764.....	797, 799
940052	993	970105	702	970302.....	752	970770.....	725
940064	993	970106	702	970303.....	752	975000	714
940065	993	970107	702	970304.....	752	975001.....	714
940066	993	970108	702	970305.....	752	975002	714
940067	993	970120.....	704	970306.....	752	975003	714
948109.....	302	970121.....	704	970307.....	752	975004	714
948139.....	302, 325	970122.....	704	970308.....	752	975005	714
970000	702	970123.....	704	970401	754	975006	714
970001.....	702	970125.....	704	970403.....	754	975007	714
970002	702	970126.....	704	970404.....	754	975008	714
970003	702	970127.....	704	970405.....	754	975020.....	716
970004	702	970128.....	704	970410.....	756	975021.....	716
970005	702	970129.....	704	970411	756	975022.....	716
970006	702	970140.....	706	970413.....	756	975023.....	716
970007	702	970141	706	970414.....	756	975025.....	716
970008	702	970142	706	970430.....	744	975026.....	716
970020	704	970143	706	970431.....	744	975027.....	716
970021	704	970144	706	970432.....	744	975028.....	716
970022	704	970145	706	970433.....	744	975029.....	716
970023	704	970146	706	970434.....	744	975040.....	718
970025	704	970147	706	970436.....	744	975041.....	718
970026	704	970148.....	706	970437.....	744	975042.....	718
970027	704	970160.....	708	970438.....	744	975043.....	718
970028	704	970161	708	970450.....	764	975044.....	718
970029	704	970162	708	970452.....	764	975045.....	718
970040	706	970163	708	970455.....	764	975046.....	718
970041	706	970164	708	970460.....	740	975047.....	718
970042	706	970165.....	708	970470.....	742	975060.....	720
970043	706	970166.....	708	970500	734	975061.....	720
970044	706	970167	708	970502.....	734	975062.....	720
970045	706	970168.....	708	970503.....	734	975063.....	720
970046	706	970180.....	700	970504.....	734	975064.....	720

975065.....	720	975187.....	712	975722.....	794	978171.....	755
975066.....	720	975230.....	728	975723.....	794	978175.....	773
975067.....	720	975231.....	728	975724.....	794	978180.....	765
975080.....	712	975331.....	776	975740.....	798	978181.....	765
975081.....	712	975334.....	776	975741.....	798	978191.....	735
975082.....	712	975341.....	782	975781.....	800	978201.....	737
975083.....	712	975343.....	782	978000.....	703	978211.....	777
975084.....	712	975344.....	782	978001.....	703	978221.....	783
975085.....	712	975345.....	782	978002.....	703	978231.....	787
975086.....	712	975350.....	786	978010.....	705	978241.....	739
975087.....	712	975351.....	786	978011.....	705	978242.....	739
975100.....	714	975352.....	786	978012.....	705	978250.....	763
975101.....	714	975353.....	786	978020.....	707	978251.....	763
975102.....	714	975360.....	778	978021.....	707	978252.....	763
975103.....	714	975361.....	778	978022.....	707	978260.....	769
975104.....	714	975364.....	778	978030.....	709	978261.....	769
975105.....	714	975365.....	778	978031.....	709	978270.....	771
975106.....	714	975367.....	778	978032.....	709	978271.....	771
975107.....	714	975369.....	778	978040.....	703	978280.....	767
975108.....	714	975370.....	784	978041.....	703	978281.....	767
975120.....	716	975371.....	784	978042.....	703	978291.....	727
975121.....	716	975375.....	784	978050.....	705	978301.....	729
975122.....	716	975376.....	784	978051.....	705	978311.....	725
975123.....	716	975377.....	784	978060.....	707	978330.....	757
975124.....	716	975379.....	784	978061.....	707	978331.....	757
975125.....	716	975381.....	788	978062.....	707	978341.....	759
975126.....	716	975384.....	788	978070.....	709	978351.....	711
975127.....	716	975385.....	788	978071.....	709	978361.....	711
975128.....	716	975389.....	788	978072.....	709	978370.....	747
975129.....	716	975390.....	780	978080.....	715	978380.....	749
975140.....	718	975391.....	780	978081.....	715	978390.....	751
975141.....	718	975394.....	780	978082.....	715	978500.....	703
975142.....	718	975395.....	780	978090.....	717	978501.....	703
975143.....	718	975411.....	758	978091.....	717	978502.....	703
975144.....	718	975412.....	758	978092.....	717	978510.....	705
975145.....	718	975460.....	766	978100.....	719	978511.....	705
975146.....	718	975462.....	766	978101.....	719	978512.....	705
975147.....	718	975470.....	768	978102.....	719	978520.....	707
975148.....	718	975471.....	768	978110.....	721	978521.....	707
975160.....	720	975474.....	768	978111.....	721	978522.....	707
975161.....	720	975475.....	768	978112.....	721	978530.....	709
975162.....	720	975476.....	768	978120.....	715	978531.....	709
975163.....	720	975481.....	770	978121.....	715	978532.....	709
975164.....	720	975483.....	770	978122.....	715	978540.....	703
975165.....	720	975485.....	770	978130.....	717	978541.....	703
975166.....	720	975486.....	770	978131.....	717	978542.....	703
975167.....	720	975490.....	762	978132.....	717	978550.....	705
975168.....	720	975491.....	762	978140.....	719	978551.....	705
975180.....	712	975494.....	762	978141.....	719	978552.....	705
975181.....	712	975495.....	762	978142.....	719	978560.....	707
975182.....	712	975496.....	762	978150.....	721	978561.....	707
975183.....	712	975498.....	762	978151.....	721	978562.....	707
975184.....	712	975501.....	772	978152.....	721	978570.....	709
975185.....	712	975720.....	794	978161.....	711	978571.....	709
975186.....	712	975721.....	794	978170.....	755	978572.....	709

978580.....	715	979042.....	717	979502.....	705	979690.....	713
978581.....	715	979050.....	719	979510.....	707	979691.....	713
978582.....	715	979051.....	719	979511.....	707	979692.....	713
978590.....	717	979052.....	719	979512.....	707	979700.....	769
978591.....	717	979060.....	717	979520.....	705	979701.....	769
978592.....	717	979061.....	717	979521.....	705	979710.....	771
978600.....	719	979062.....	717	979522.....	705	979711.....	771
978601.....	719	979070.....	719	979530.....	707	979721.....	727
978602.....	719	979071.....	719	979531.....	707	979731.....	729
978610.....	721	979072.....	719	979532.....	707	979741.....	725
978611.....	721	979080.....	703	979540.....	717	979751.....	745
978612.....	721	979081.....	703	979541.....	717	979760.....	747
978620.....	715	979082.....	703	979542.....	717	979770.....	749
978621.....	715	979090.....	709	979550.....	719	979780.....	751
978622.....	715	979091.....	709	979551.....	719	980000.....	705
978630.....	717	979092.....	709	979552.....	719	980001.....	705
978631.....	717	979100.....	703	979560.....	717	980002.....	705
978632.....	717	979101.....	703	979561.....	717	980010.....	705
978640.....	719	979102.....	703	979562.....	717	980011.....	705
978641.....	719	979110.....	709	979570.....	719	980012.....	705
978642.....	719	979111.....	709	979571.....	719	980020.....	731
978650.....	721	979112.....	709	979572.....	719	980021.....	731
978651.....	721	979120.....	715	979580.....	703	980023.....	731
978652.....	721	979121.....	715	979581.....	703	980040.....	717
978660.....	701	979122.....	715	979582.....	703	980041.....	717
978661.....	701	979130.....	721	979590.....	709	980042.....	717
978662.....	701	979131.....	721	979591.....	709	980060.....	717
978670.....	701	979132.....	721	979592.....	709	980061.....	717
978671.....	701	979140.....	715	979600.....	703	980062.....	717
978672.....	701	979141.....	715	979601.....	703	980501.....	783
978680.....	713	979142.....	715	979602.....	703	980511.....	787
978681.....	713	979150.....	721	979610.....	709	980520.....	765
978682.....	713	979151.....	721	979611.....	709	980521.....	765
978690.....	713	979152.....	721	979612.....	709	980530.....	767
978691.....	713	979160.....	701	979620.....	715	980531.....	767
978692.....	713	979161.....	701	979621.....	715	980541.....	753
978700.....	753	979162.....	701	979622.....	715	980550.....	747
978701.....	753	979170.....	701	979630.....	721	980560.....	749
978702.....	753	979171.....	701	979631.....	721	980570.....	751
978711.....	727	979172.....	701	979632.....	721	981001.....	793
978721.....	729	979180.....	713	979640.....	715	981011.....	795
979000.....	705	979181.....	713	979641.....	715	981021.....	801
979001.....	705	979182.....	713	979642.....	715	981031.....	797
979002.....	705	979190.....	713	979650.....	721	981041.....	799
979010.....	707	979191.....	713	979651.....	721	983000.....	703, 715, 777, 781, 783, 787
979011.....	707	979192.....	713	979652.....	721	983001.....	703, 715, 777, 781, 783, 787
979012.....	707	979200.....	769	979660.....	701	983002.....	703, 715, 777, 781, 783, 787
979020.....	705	979201.....	769	979661.....	701	983003.....	703, 715, 777, 781, 783, 787
979021.....	705	979210.....	771	979662.....	701	983004.....	703, 715, 777, 781, 783, 787
979022.....	705	979211.....	771	979670.....	701	983005.....	703, 715, 777, 781, 783, 787
979030.....	707	979221.....	727	979671.....	701		
979031.....	707	979231.....	729	979672.....	701		
979032.....	707	979241.....	725	979680.....	713		
979040.....	717	979500.....	705	979681.....	713		
979041.....	717	979501.....	705	979682.....	713		

781, 783, 787	983027.....707, 719, 727,	753, 755	984011705, 717, 739,
983006703, 715, 777,	729, 757, 759, 763, 779,	983512.....705, 717, 739,	755, 769, 771
781, 783, 787	785, 789	753, 755	984012705, 717, 739,
983007703, 715, 777,	983028.....707, 719, 727,	983513.....705, 717, 739,	755, 769, 771
781, 783, 787	729, 757, 759, 763, 779,	753, 755	984013705, 717, 739,
983008703, 715, 777,	785, 789	983514.....705, 717, 739,	755, 769, 771
781, 783, 787	983030.....709, 721, 743	753, 755	984014705, 717, 739,
983010705, 717,	983031.....709, 721, 743	983515.....705, 717, 739,	755, 769, 771
735, 737, 739, 753, 755,	983032.....709, 721, 743	753, 755	984015705, 717, 739,
765, 767, 769, 771	983033.....709, 721, 743	983516.....705, 717, 739,	755, 769, 771
983011705, 717,	983034.....709, 721, 743	753, 755	984017705, 717, 739,
735, 737, 739, 753, 755,	983035.....709, 721, 743	983517.....705, 717, 739,	755, 769, 771
765, 767, 769, 771	983036.....709, 721, 743	753, 755	984018705, 717, 739,
983012705, 717,	983037.....709, 721, 743	983518.....705, 717, 739,	755, 769, 771
735, 737, 739, 753, 755,	983038.....709, 721, 743	753, 755	984022.....707, 719, 727,
765, 767, 769, 771	983040.....711, 725, 741,	983520.....707, 719, 727,	729, 757, 759, 779
983013705, 717,	743	729, 757, 759	984023.....707, 719, 727,
735, 737, 739, 753, 755,	983041.....711, 725, 741,	983521.....707, 719, 727,	729, 757, 759, 779
765, 767, 769, 771	743	729, 757, 759	984024.....707, 719, 727,
983014705, 717,	983044.....711, 725, 741,	983522.....707, 719, 727,	729, 757, 759, 779
735, 737, 739, 753, 755,	743	729, 757, 759	984025.....707, 719, 727,
765, 767, 769, 771	983045.....711, 725, 741,	983523.....707, 719, 727,	729, 757, 759, 779
983015705, 717,	743	729, 757, 759	984026.....707, 719, 727,
735, 737, 739, 753, 755,	983046.....711, 725, 741,	983524.....707, 719, 727,	729, 757, 759, 779
765, 767, 769, 771	743	729, 757, 759	984032.....709, 721, 743
983016705, 717,	983060.....705, 717,	983525.....707, 719, 727,	984033.....709, 721, 743
735, 737, 739, 753, 755,	735, 737, 739, 753, 755,	729, 757, 759	984034.....709, 721, 743
765, 767, 769, 771	765, 767, 769, 771	983526.....707, 719, 727,	984035.....709, 721, 743
983017705, 717,	983061.....705, 717,	729, 757, 759	984036.....709, 721, 743
735, 737, 739, 753, 755,	735, 737, 739, 753, 755,	983527.....707, 719, 727,	984044.....711, 725, 741,
765, 767, 769, 771	765, 767, 769, 771	729, 757, 759	743
983018705, 717,	983062.....705, 717,	983530.....709, 721, 743	984045.....711, 725, 741,
735, 737, 739, 753, 755,	735, 737, 739, 753, 755,	983531.....709, 721, 743	743
765, 767, 769, 771	765, 767, 769, 771	983532.....709, 721, 743	984054.....701, 713
983020.....707, 719, 727,	983080.....735	983533.....709, 721, 743	984055.....701, 713
729, 757, 759, 763, 779,	983081.....735	983534.....709, 721, 743	984502.....703, 715
785, 789	983082.....735	983535.....709, 721, 743	984503.....703, 715
983021.....707, 719, 727,	983090.....731	983536.....709, 721, 743	984504.....703, 715
729, 757, 759, 763, 779,	983091.....731	983539.....709, 721, 743	984505.....703, 715
785, 789	983100.....747	983550.....701, 713	984510705, 717, 755,
983022.....707, 719, 727,	983101747	983551.....701, 713	769, 771
729, 757, 759, 763, 779,	983110749	983554.....701, 713	984511705, 717, 755,
785, 789	983111749	983555.....701, 713	769, 771
983023.....707, 719, 727,	983120.....751	983560.....705, 717, 739,	984512.....705, 717, 755,
729, 757, 759, 763, 779,	983121.....751	753, 755	769, 771
785, 789	983500703, 715	983561.....705, 717, 739,	984513.....705, 717, 755,
983024.....707, 719, 727,	983501703, 715	753, 755	769, 771
729, 757, 759, 763, 779,	983502.....703, 715	983562.....705, 717, 739,	984514.....705, 717, 755,
785, 789	983503.....703, 715	753, 755	769, 771
983025.....707, 719, 727,	983504.....703, 715	984002703, 715, 781	984515.....705, 717, 755,
729, 757, 759, 763, 779,	983505.....703, 715	984003703, 715, 781	769, 771
785, 789	983506.....703, 715	984004703, 715, 781	984517705, 717, 755,
983026.....707, 719, 727,	983510.....705, 717, 739,	984005703, 715, 781	769, 771
729, 757, 759, 763, 779,	753, 755	984010705, 717, 739,	984518.....705, 717, 755,
785, 789	983511705, 717, 739,	755, 769, 771	769, 771

984522.....	707, 719, 727, 729, 757, 759	987025.....	731
984523.....	707, 719, 727, 729, 757, 759	987026.....	731
984524.....	707, 719, 727, 729, 757, 759	987027.....	731
984525.....	707, 719, 727, 729, 757, 759	987040.....	729, 763, 769
984526.....	707, 719, 727, 729, 757, 759	987060.....	727, 751
984532.....	709, 721, 743	987080.....	
984533.....	709, 721, 743		703, 705, 707, 709, 711, 715, 717, 719, 721, 759
984534.....	709, 721, 743	988021.....	729
984535.....	709, 721, 743	988025.....	793, 795
984544.....	711, 725, 741, 743	988028.....	793, 795
984545.....	711, 725, 741, 743	988054.....	801
984554.....	701, 713	988055.....	801
984555.....	701, 713	988084.....	797, 799
984565.....	745	988085.....	797, 799
984568.....	745	990109.....	801, 805
984570.....	747		
984571.....	747		
984580.....	749		
984581.....	749		
984590.....	751		
984591.....	751		
985010.....	705, 717, 755		
985011.....	705, 717, 755		
985016.....	705, 717, 755		
985504.....	783, 787		
985505.....	783, 787		
985508.....	783, 787		
985514.....	765		
985515.....	765		
985518.....	765		
985554.....	767		
985555.....	767		
985558.....	767		
985570.....	747		
985571.....	747		
985580.....	749		
985581.....	749		
985590.....	751		
985591.....	751		
985601.....	773		
985605.....	773		
987002.....	703, 715		
987004.....	705, 717		
987006.....	707, 719, 759		
987008.....	709, 721		
987010.....	711		
987020.....	727, 729, 751, 763, 769		

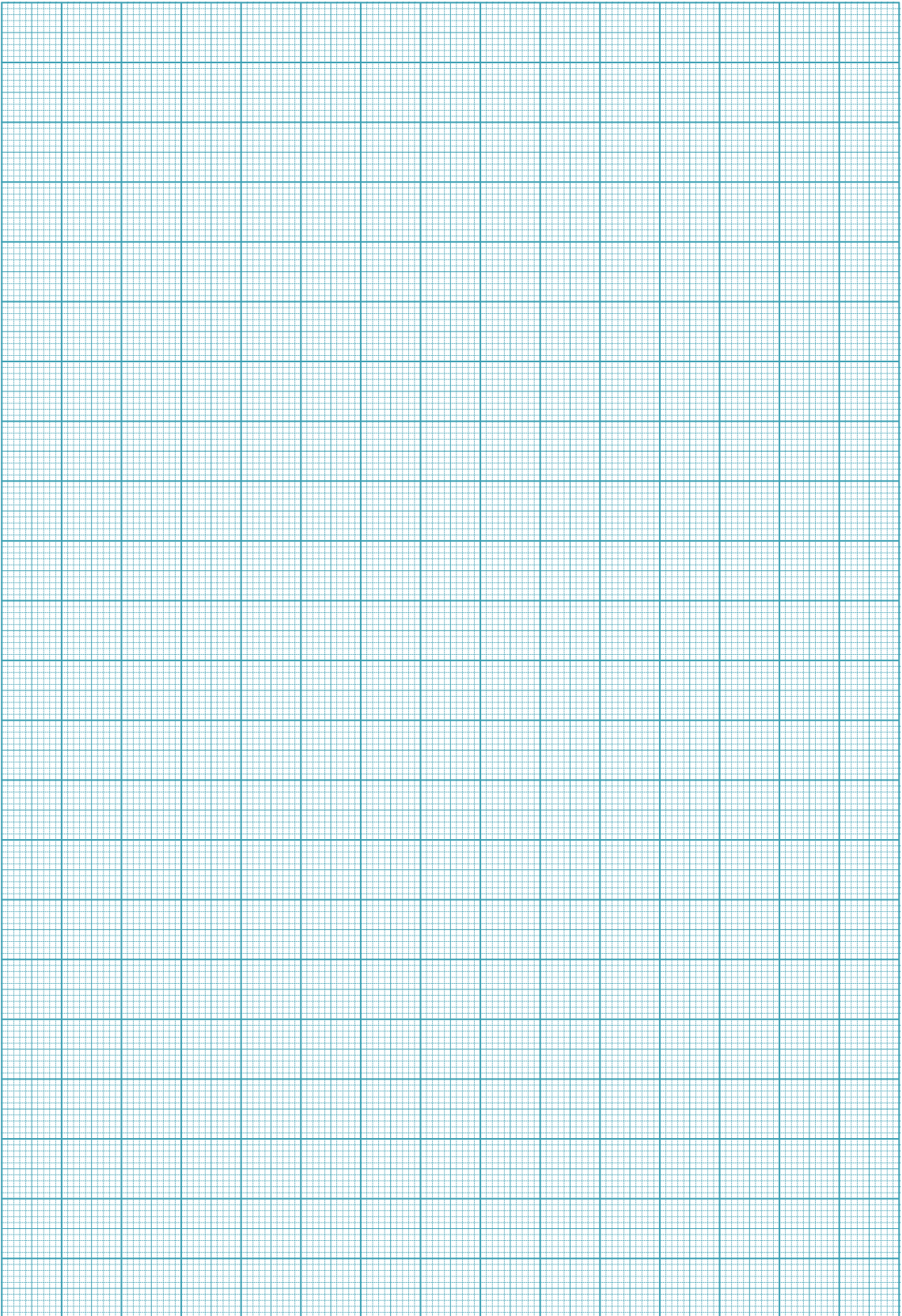

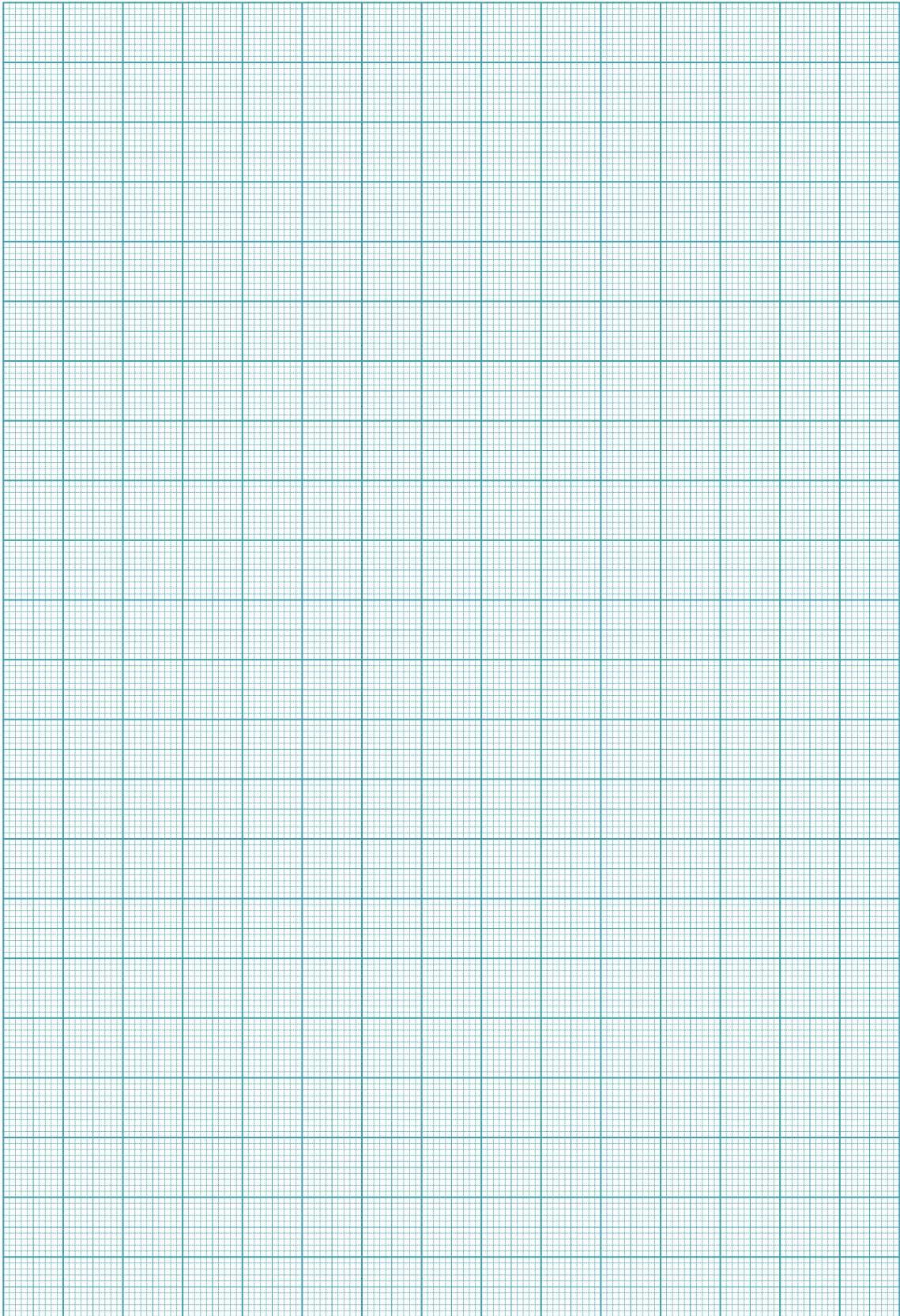

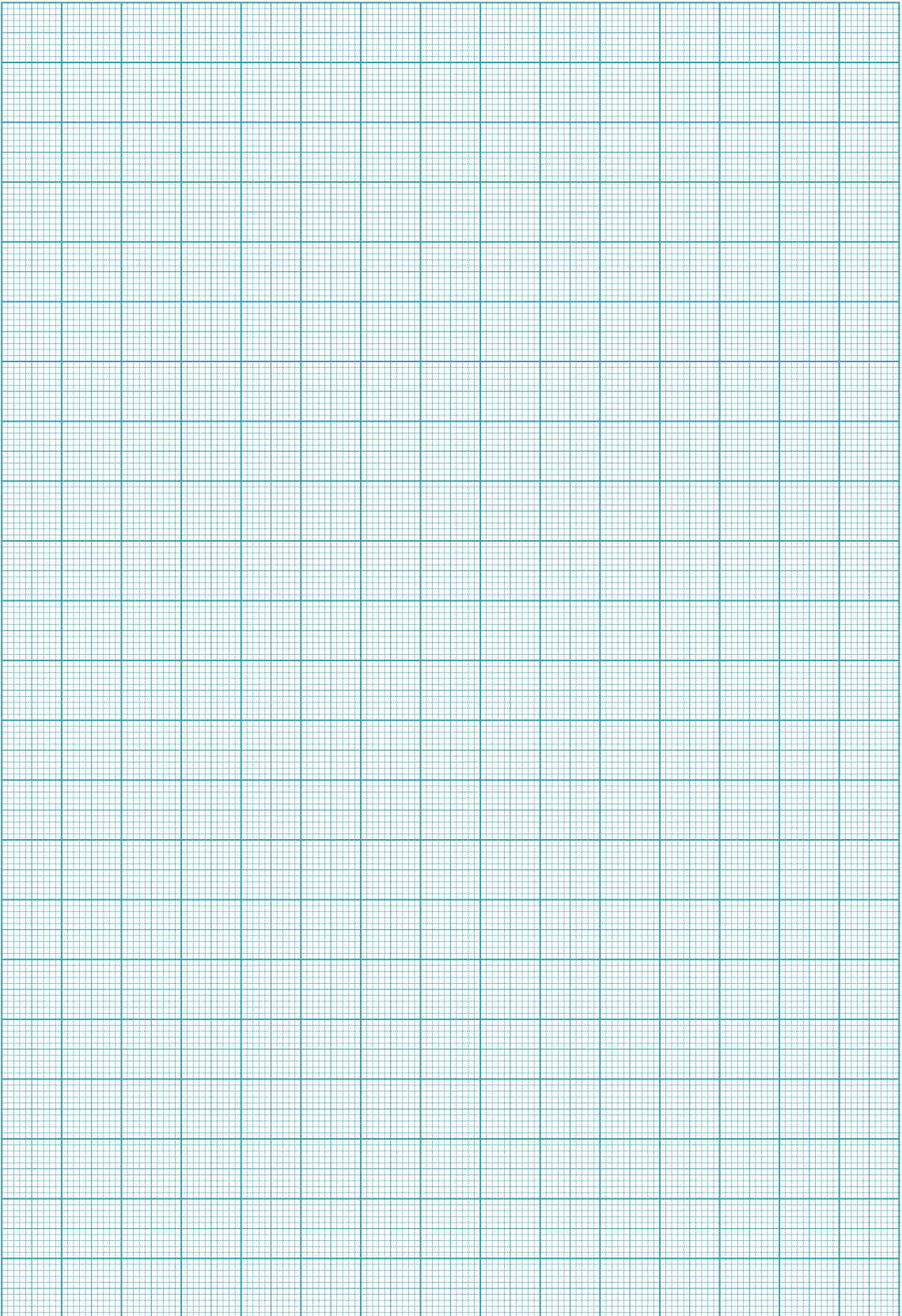



Hersteller / manufacturer: DEKO-LIGHT Elektronik Vertriebs GmbH



Exaltation BV
Groethofstraat 103
5916 PA Venlo NL
T +31 – 77 – 7502305
E info@exaltation.eu
www.exaltation.eu