

**Artikel Nr.: 862185**

Netzgerät, Multi CC, PRO-UA440-B Schienensystem 3-Phasen 230V











IP20 

**Elektrische Daten**

Betriebsart	stromkonstant	Eingangsspannung	220-240V AC/50-60Hz
Leistung	22,95-44,10 W	Leistungsfaktor	0,97
Ausgangsspannung	27-42V DC	Anschlußmöglichkeit	Klemme
Ausgangsstrom	850/900/950/1050 mA		

**Produkteigenschaften**

 Schutzklasse I	 Überspannungsschutz
SELV Schutzkleinspannung	 Lampenbetriebsgerät 110
 Kurzschlußfest	 Möbeleinbau nicht geeignet
 Überlastschutz	ErP Standby-Stromverbrauch < 0,5 W
 Übertemperaturschutz	LVD Sicherheit nach EN 61347
 Sicherheitstrafo	EMC Funkentstörung + Störfestigkeit nach EN 55015 + EN 61547
 nicht dimmbar	EMC Netzstromoberwellen + Flicker nach EN 61000-3-2 + EN 61000-3-3

Schwarze Felder sind zutreffend / graue Felder sind nicht zutreffend

Artikel Nr.: 862185

Netzgerät, Multi CC, PRO-UA440-B Schienensystem 3-Phasen 230V

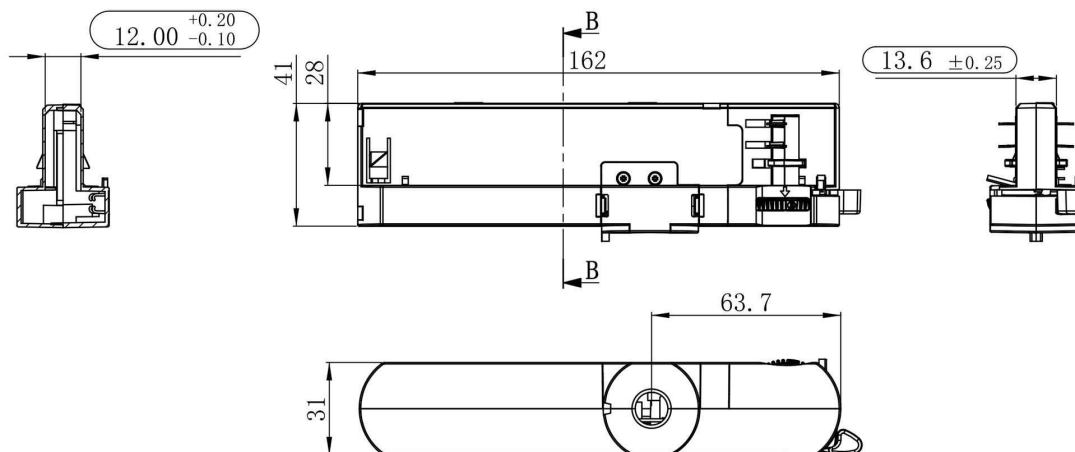

Abmessungen und Gewicht

Grenzwerte

Länge	16,00 mm	Betriebstemperatur	-20°C - +35°C
Breite	31,00 mm	Gehäusetemperatur	75 °C
Höhe	41,00 mm	max. Menge Sicherungsautomaten	
Durchmesser	0,00 mm	max. Einschaltstrom	
Gewicht	113 g	kapazitive Last	

Multi-CC variable Leistungs-/Spannungsbereiche / Multi-CC variable power/voltage ranges

Stromstärke / Current	Leistung / Power	Spannung / Voltage
850mA	22,95W - 35,70W	27V - 42V
900mA	24,30W - 37,80W	27V - 42V
950mA	25,65W - 39,90W	27V - 42V
1050mA	28,35W - 44,10W	27V - 42V

max. 2 Lampen je Kanal - Spannungsbereich überprüfen! / max. 2 lamps per channel - check voltage range!

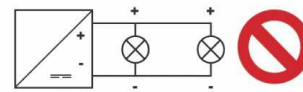
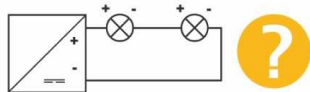

Article No.: 862185

Power supply unit, Multi CC, PRO-UA440-B Track system 3-Phases 230V











IP20 

### Electrical Characteristics

Operating mode	constant voltage	Input voltage	220-240V AC/50-60Hz
Power	22,95-44,10 W	Power factor	0,97
Output voltage	27-42V DC	Connection possibility	clamp
Output current	850/900/950/1050 mA		

### Product features

 Protection class I	 Overvoltage protection
SELV Low voltage protection	 Lamp control gear 110
 Short circuit protection	 Not suitable for furniture installation
 Overload protection	ErP Standby-power consumption < 0,5 W
 Overheating protection	LVD Safety according to EN 61347
 Safety transformer	EMC Interference suppression + immunity according to EN 55015 + EN 61547
 not dimmable	EMC Mains harmonics + flicker according to EN 61000-3-2 + EN 61000-3-3

Black fields are applicable / gray fields are not applicable

**Article No.: 862185**

Power supply unit, Multi CC, PRO-UA440-B Track system 3-Phases 230V

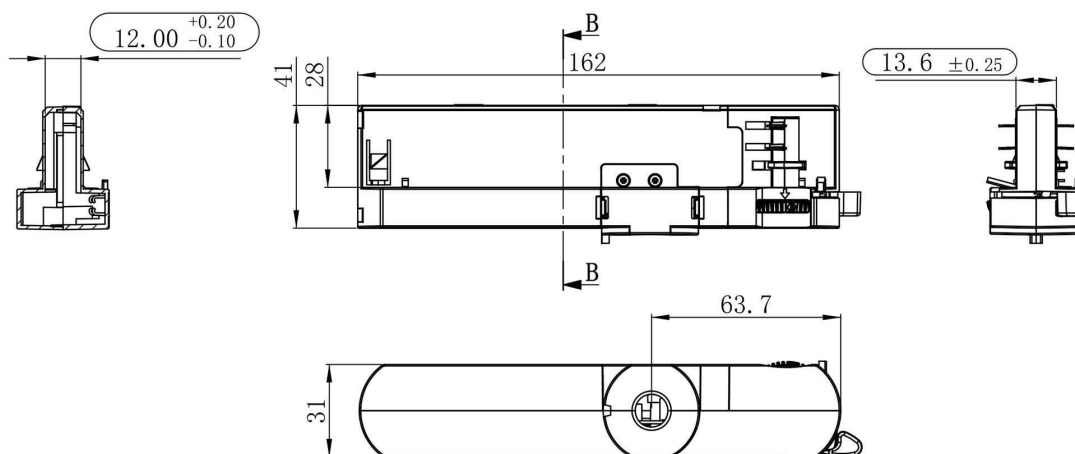

**Dimensions & Weight**

**Absolute maximum ratings**

Length	16,00 mm	Operating temperature	-20°C - +35°C
Width	31,00 mm	Case temperature	75 °C
Height	41,00 mm	max. amount of circuit breakers	
Diameter	0,00 mm	max. inrush current	
Product weight	113 g	capacitive load	

**Multi-CC variable Leistungs-/Spannungsbereiche / Multi-CC variable power/voltage ranges**

Stromstärke / Current	Leistung / Power	Spannung / Voltage
850mA	22,95W - 35,70W	27V - 42V
900mA	24,30W - 37,80W	27V - 42V
950mA	25,65W - 39,90W	27V - 42V
1050mA	28,35W - 44,10W	27V - 42V

**max. 2 Lampen je Kanal - Spannungsbereich überprüfen! / max. 2 lamps per channel - check voltage range!**

